

PUBLICATION NUMBER MR-04452
April 18, 1996



SM SERIES PUMPS SM4G'S AND SM4J'S

All Materials And Voltages

**MANUAL
PART 3 of 3**

**MAINTENANCE
AND
REPAIR
WITH
TROUBLESHOOTING**

THE GORMAN-RUPP COMPANY • MANSFIELD, OHIO

GORMAN-RUPP OF CANADA LIMITED • ST. THOMAS, ONTARIO, CANADA Printed in U.S.A.

©Copyright by the Gorman-Rupp Company

INTRODUCTION

Thank You for purchasing a Gorman-Rupp SM Series Pump. **Read this manual** carefully to learn how to safely maintain and service your pump. Failure to do so could result in personal injury or damage to the pump.

A set of three manuals accompanies your pump. The Installation/Operation Manual contains essential information on installing and operating the pump, and on making electrical connections. The Parts List Manual provides a performance curve, a pump model cross-section drawing, and parts list for your pump.

This Maintenance and Repair Manual provides troubleshooting and maintenance instructions required to properly diagnose operational problems, and to service the pump components. Pump motor maintenance may be performed **only** by a Gorman-Rupp authorized Submersible repair facility, or the factory. Otherwise, the pump warranty will be negated, and damage to the pump, and injury or death to personnel can result. Contact the factory for the authorized repair facility closest to you.

As described on the following page, this manual will alert personnel to known procedures which re-

quire special attention, to those which could damage equipment, and to those which could be dangerous to personnel. However, this manual cannot possibly anticipate and provide detailed precautions for every situation that might occur during maintenance of the unit. Therefore, it is the responsibility of the owner/maintenance personnel to ensure that **only** safe, established maintenance procedures are used, and that any procedures not addressed in this manual are performed **only** after establishing that neither personal safety nor pump integrity are compromised by such practices.

If there are any questions regarding the pump which are not covered in this manual or in other literature accompanying the unit, please contact your Gorman-Rupp distributor or the Gorman-Rupp Company:

The Gorman-Rupp Company
P.O. Box 1217
Mansfield, Ohio 44901-1217
or:

Gorman-Rupp of Canada Limited
70 Burwell Road
St. Thomas, Ontario N5P 3R7

CONTENTS

SAFETY – SECTION A

TROUBLESHOOTING – SECTION B

ELECTRICAL TESTING	PAGE B – 2
Test Equipment	PAGE B – 3
Voltage Imbalance	PAGE B – 3
Motor and Power Cable Continuity	PAGE B – 3
Insulation Resistance	PAGE B – 4

PUMP MAINTENANCE AND REPAIR – SECTION C

GENERAL INFORMATION	PAGE C – 1
Lifting	PAGE C – 1
TYPICAL PUMP ASSEMBLY	PAGE C – 2
PUMP ASSEMBLY PARTS IDENTIFICATION LIST	PAGE C – 3
TYPICAL TERMINAL HOUSING & CABLE ASSEMBLY	PAGE C – 4
TERMINAL HOUSING & CABLE ASSEMBLY PARTS IDENTIFICATION LIST	PAGE C – 5
PUMP END DISASSEMBLY	PAGE C – 6
PUMP END REASSEMBLY	PAGE C – 8
MOTOR DISASSEMBLY	PAGE C – 11
MOTOR REASSEMBLY	PAGE C – 15
FINAL ASSEMBLY	PAGE C – 20
VACUUM TESTING	PAGE C – 21
LUBRICATION	PAGE C – 22

RECORDING MODEL AND SERIAL NUMBERS

Please record the pump model, serial number, voltage, and motor frame size in the spaces provided below. Your Gorman-Rupp distributor needs this information when you require parts or service.

Pump Model: _____

Serial Number: _____

Voltage: _____

Phase: _____

WARRANTY INFORMATION

The warranty provided with your pump is part of Gorman-Rupp's support program for customers

The following are used to alert personnel to procedures which require special attention, to those which could damage equipment, and to those which could be dangerous to personnel:



Immediate hazards which WILL result in severe personal injury or death. These instructions describe the procedure required and the injury which will result from failure to follow the procedure.



Hazards or unsafe practices which COULD result in severe personal injury or death. These instructions describe the procedure required and the injury which could result from failure to follow the procedure.

who operate and maintain their equipment as described in this and the other accompanying literature. The integral electric motor must be operated through the control furnished with the pump as standard equipment and approved by MSHA. Please note that should the equipment be abused or modified to change its performance beyond the original factory specifications, the warranty will become void and any claim will be denied.

All repairs to the pump motor **must** be performed by a Gorman-Rupp authorized Submersible repair facility or the factory. Any repairs to the motor assembly performed by the customer or an unauthorized repair facility negates motor warranty.



Hazards or unsafe practices which COULD result in minor personal injury or product or property damage. These instructions describe the requirements and the possible damage which could result from failure to follow the procedure.

NOTE

Instructions to aid in installation, operation, and maintenance or which clarify a procedure.

SAFETY – SECTION A

The following information applies throughout this manual to Gorman-Rupp SM Series submersible motor driven pumps.

This manual will alert personnel to known procedures which require special attention, to those which could damage equipment, and to those which could be dangerous to personnel. However, this manual cannot possibly anticipate and provide detailed instructions and precautions for every situation that might occur during maintenance of the unit. Therefore, it is the responsibility of the owner/maintenance personnel to ensure that only safe, established maintenance procedures are used, and that any procedures not addressed in this manual are performed only after establishing that neither personal safety nor pump integrity are compromised by such practices.

This manual contains essential information on troubleshooting and maintaining the pump. In addition to this manual, see the separate literature covering installation and operation, pump parts, and any optional equipment shipped with the pump.

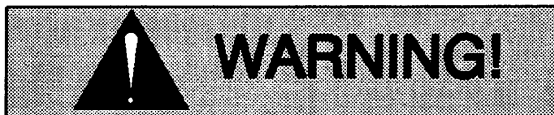

Before attempting to open or service the pump:

1. Familiarize yourself with this manual.
2. Lock out incoming power to the control box to ensure that the pump will remain inoperative.
3. Allow the pump to completely cool if overheated.

4. Close the discharge valve (if used).



This pump is not designed to pump volatile, explosive, or flammable materials. Do not attempt to pump any liquids for which your pump is not approved, or which may damage the pump or endanger personnel as a result of pump failure. Consult the factory for specific application data.



Before connecting any cable to the control box, be sure to ground the control box. Refer to the Control Box manual for the suggested grounding methods.

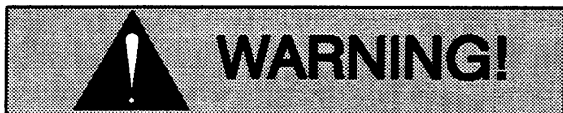

The pump is designed to be operated through the control box furnished with the pump. The control box provides overload protection and power control. Do not connect the pump motor directly to the incoming power lines.

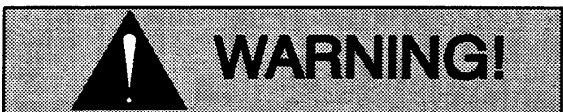

When installing or servicing the pump or controls, follow all requirements for the installation of wiring or electrical equipment as outlined by MSHA SCHEDULE 2G. Follow all MSHA safety requirements. Failure to observe these requirements could result in injury or death to personnel.

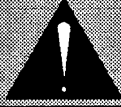
**WARNING!**

The electrical power used to operate this pump is high enough to cause injury or death. Obtain the services of a qualified electrician to make all electrical connections. Make certain that the pump and enclosure are properly grounded; never use gas pipe as an electrical ground. Be sure that the incoming power matches the voltage and phase of the pump and control before connecting the power source. Do not run the pump if the voltage is not within the limits. If the overload unit is tripped during pump operation, correct the problem before restarting the pump.

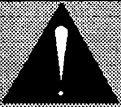
**WARNING!**

The electrical power used to operate this pump is high enough to cause injury or death. Make certain that the control handle on the control box is in the OFF position and locked out, or that the power supply to the control box has been otherwise cut off and locked out, before attempting to open or service the pump assembly. Tag electrical circuits to prevent accidental start-up.

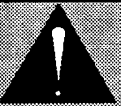
**WARNING!**

Any control box used to operate the pump must be approved by the MSHA and the Gorman-Rupp Company for the application.

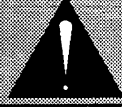
**WARNING!**

Never attempt to alter the length or repair any power cable with a splice. The pump motor and cable must be completely waterproof. Injury or death may result from alterations.

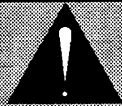
**WARNING!**

All electrical connections must be in accordance with MSHA Schedule 2G. If there is a conflict between the instructions provided and MSHA specifications, MSHA specifications shall take precedence. All electrical equipment supplied with this pump was in conformance with MSHA requirements in effect on the date of manufacture. Failure to follow applicable specifications, or substitution of electrical parts not supplied or approved by the manufacturer, can result in severe injury or death.

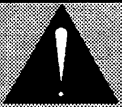
**WARNING!**

After the pump has been installed, make certain that the pump and all piping or hose connections are secure before operation.

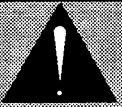
**WARNING!**

Approach the pump cautiously after it has been running. Although the motor is cooled by the liquid being pumped, normal operating temperatures can be high enough to cause burns. The temperature will be especially high if operated against a closed discharge valve. Never

operate against a closed discharge valve for long periods of time.

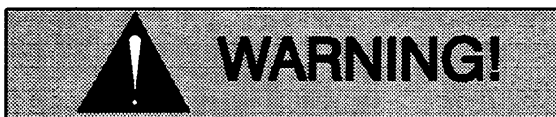

Do not attempt to lift the pump by the motor power cable or the piping. Attach proper lifting equipment to the lifting device fitted to the pump. If chains or cable are wrapped around the pump to

lift it, make certain that they are positioned so as not to damage the pump, and so that the load will be balanced.

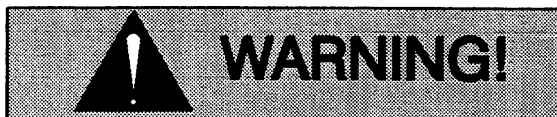

Obtain the services of a qualified electrician to troubleshoot, test and/or service the electrical components of this pump.

TROUBLESHOOTING – SECTION B

Review all SAFETY information in Section A.



The following precautions should be taken before attempting to service the pump; otherwise, injury or death could result.

1. Familiarize yourself with this manual and with all other literature shipped with the pump.
2. Lock out incoming power to the pump or control box to ensure that the pump will remain inoperative.
3. Allow the pump to completely cool if overheated.
4. Check the temperature before opening any covers, plates or plugs.

5. Close the discharge valve (if used).

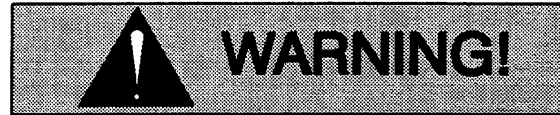

The electrical power used to operate this pump is high enough to cause injury or death. Obtain the services of a qualified electrician to troubleshoot, test and/or service the electrical components of this pump.

NOTE

Many of the probable remedies listed below require use of electrical test instruments; for specific procedures, see **ELECTRICAL TESTING** following the chart.

Table B-1 Troubleshooting Chart

TROUBLE	CAUSE	REMEDY
PUMP FAILS TO START, CIRCUIT BREAKER NOT TRIPPED	Power source incompatible with control box.	Correct power source.
	No voltage at line side of circuit breaker.	Check power source for blown fuse, open overload unit, broken lead, or loose connection.
	Open circuit in motor windings or power cable.	Check continuity.
	Defective motor power cable.	Check for and replace defective unit.
CIRCUIT BREAKER TRIPS	Low or high voltage, or excessive voltage drop between pump and control box.	Measure voltage at control box. Check that wiring is correct type, size, and length. (See Field Wiring Connections , Operations And Maintenance Manual.
	Defective insulation in motor windings.	Check insulation resistance; check continuity.
	Impeller jammed due to debris or insufficient clearance.	Disassemble pump and check impeller.
	Bearing(s) frozen.	Disassemble pump and check bearing(s).

Table B-1 Troubleshooting Chart (continued)

TROUBLE	CAUSE	REMEDY
MOTOR RUNS, BUT PUMP FAILS TO DELIVER RATED DISCHARGE	Discharge head too high.	Reduce discharge head, or install staging adaptor and additional pump.
	Low or incorrect voltage.	Measure control box voltage, both when pump is running and when shut off.
	Discharge throttling valve partially closed; check that valve is installed improperly.	Open discharge valve fully; check piping installation.
	Discharge line clogged or restricted; hose kinked.	Check discharge lines; straighten hose.
	Liquid being pumped too thick.	Dilute liquid if possible.
	Strainer screen or impeller clogged.	Clear clog(s). Stop pump; back flow may flush away debris.
	Insufficient liquid in sump or tank.	Stop pump until liquid level rises.
	Worn impeller vanes; excessive impeller clearance.	Check impeller and clearance. See PUMP END REASSEMBLY .
	Pump running backwards.	Check direction of rotation and correct by interchanging any two motor leads at control box. (See Pump Rotation , Section C).
PUMP RUNS WITH EXCESSIVE NOISE OR VIBRATION	Pumping entrained air.	Check liquid level in sump; check position of pump and liquid level sensing device(s).
	Damaged or unbalanced impeller.	Replace impeller.
	Discharge piping not properly supported.	Check piping installation.
	Impeller jammed or loose.	Check impeller.
	Pump cavitation.	Reduce discharge head, or restrict flow on low head applications.
	Motor shaft or bearings defective.	Disassemble pump and check motor and bearings.

ELECTRICAL TESTING

If you suspect that pump malfunctions are caused by defects in the motor, power cable or control box, perform the following checks to help isolate the defective part.

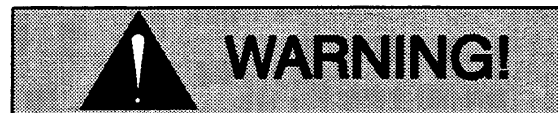

Obtain the services of a qualified electrician to troubleshoot, test and/or service the electrical components of this pump.



Be certain to refer to the wiring diagram(s) before reconnecting any electrical components which have been disconnected.

Test Equipment

A volt/amp/ohmmeter and megohmmeter of adequate range and quality will be required to conduct the following electrical tests. The suggested equipment indicated below is commercially available, or an equivalent substitute may be used.

Equipment	Use
Ammeter	To check AC Voltage and current (amperage)
Ohmmeter	To measure resistance (ohms) to ground

Voltage Imbalance

Each phase of the incoming three-phase power must be balanced with the other two as accurately as a commercial voltmeter will read. If the phases are balanced, check out the motor as described below. If the phases are out of balance, contact your power company and request that they correct the condition.

- a. Use a voltmeter, amprobe, or equivalent meter to read the voltage across terminals 1 & 2, 2 & 3, and 1 & 3 in the control box. All three measured voltages must be the same, as accurately as the meter will read. If possible, measure the voltage with the pump off, with the pump running but out of the water, and with the pump running in the water at full load. All the measured voltages at each condition must be the same.
- b. Use an amprobe or equivalent meter to measure the current draw of each phase while the pump is running at full load and at no load. All three amperage readings must

be the same at each condition, as accurately as the meter will read. Nominal amperage values are listed in Table 1, but these apply only when the actual voltage at the site is the nominal voltage listed.

- c. If the voltages are balanced with the pump off, but are unbalanced when the pump is running, a thorough check of the power source, all interconnecting cables, and the pump motor is required to isolate the defect.

Motor And Motor Power Cable Continuity

To check continuity, zero-balance the ohmmeter set at the RX1 scale, and test as follows:

- a. Disconnect the motor power cable leads from the control box and connect the test leads to any two of the three power cable leads (not to the green ground lead or yellow ground check lead). If there is a high resistance reading on the ohmmeter, there is an open or broken circuit cause a break in the power cable or motor windings, or by a bad connection between the motor and the power cable. Switch one test lead to the third power lead, and test again.
- b. If an open or broken circuit is indicated, check the power cable for obvious damage, and replace as necessary (see **MAINTENANCE AND REPAIR**). If there is no apparent damage to the motor cable, remove the terminal housing (see **MAINTENANCE AND REPAIR**) and check the continuity of each power cable lead at the terminal posts.
- c. If an open circuit still exists after each lead (terminal) has been tested and tightened, then the **entire** motor power cable must be replaced. Splicing or other means of repair are not recommended.
- d. If no break is found in the power cable, check the motor leads for continuity. If the test reading indicates an open or broken circuit, there is an open circuit in the motor.

NOTE

It is recommended that a pump with a defective motor be returned to Gorman-Rupp, or to one of the Gorman-Rupp authorized Submersible Repair centers.

Insulation Resistance

To check insulation, zero-balance the ohmmeter set at the RX100K scale, and test as follows:

- a. Disconnect the motor power cable leads from the control box. Connect one test lead to the power cable green ground lead, and touch the other test lead to each of the three power leads in turn.
- b. The reading obtained will indicate resistance values in both the power cable and the motor windings. If the resistance reading is infinity (∞), the insulation is in good condi-

tion. If the reading is between infinity (∞) and 1 megohm, the insulation is acceptable but should be rechecked periodically. If the reading is less than 1 megohm, the insulation should be checked more closely; a reading of zero indicates that the power cable or the motor is grounded.

- c. To determine whether the power cable or the motor is grounded, remove the terminal housing (see **MAINTENANCE AND REPAIR**), disconnect the motor leads from the motor terminals, and test the power cable leads and motor leads separately.

PUMP MAINTENANCE AND REPAIR – SECTION C

GENERAL INFORMATION

Review all SAFETY information in Section A.

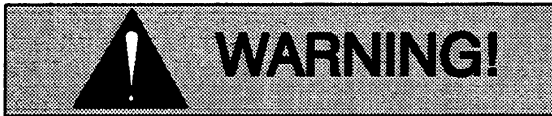

Do not attempt to service the pump assembly unless all power to the motor has been shut off at the control box; otherwise, injury or death could result.

Use a lifting device with sufficient capacity. If slings or chains are used to move the pump or components, make sure that the load is balanced; otherwise serious personal injury or death could result.

The maintenance and repair instructions in this manual are keyed to the sectional views, Figures C-1 and C-2, and the corresponding parts identification lists. Refer to the separate Parts List Manual for replacement parts.

Select a suitable location, preferably indoors, to perform required maintenance. All work must be performed by qualified personnel.

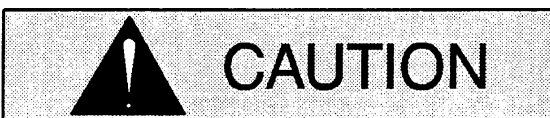

All repairs to the pump motor must be per-

formed by a Gorman-Rupp authorized Submersible repair facility or the factory. Any repairs to the motor assembly performed by the customer or an unauthorized repair facility negates the warranty.

This Maintenance and Repair Manual provides troubleshooting and maintenance instructions required to properly diagnose operational problems, and to service the pump components. Pump motor maintenance may be performed **only** by a Gorman-Rupp authorized Submersible repair facility, or the factory. Otherwise, the pump warranty will be negated, and damage to the pump, and injury or death to personnel can result. Contact the factory for the authorized repair facility closest to you.

Check **TROUBLESHOOTING**, Section B to determine causes and remedies of pump problems. Disassemble the pump only as far as required.

Lifting

Use lifting equipment with a capacity of **at least five times the weight of the pump**, including the weight of any options or customer-installed accessories. The approximate maximum weight for this group of pumps is **541 lbs. (245 kg.) for the SM4G series and 774 lbs. (351 kg.) for the SM4J series**, not including the cable. Discharge hose or piping **must** be removed before attempting to lift the pump.

SECTION DRAWING

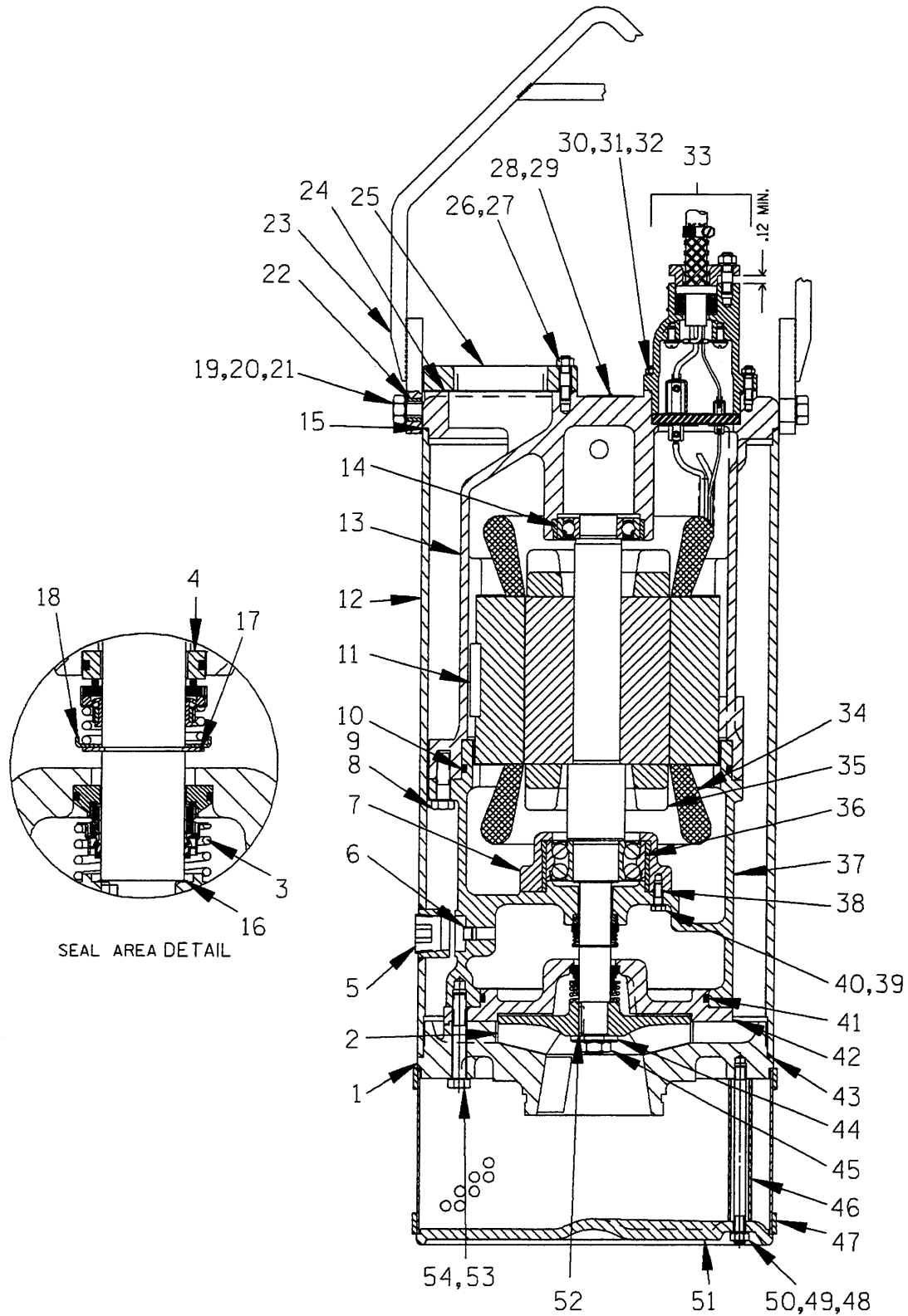

Figure C-1. Typical SM4G And SM4J Series Pump Assembly

**Typical SM4G And SM4J Series Pump Assembly
Parts Identification List**

Refer to the separate Parts List Manual for serviceable parts, part numbers and quantities.

ITEM NO.	PART NAME	ITEM NO.	PART NAME
1	DIFFUSER	28	NAME PLATE
2	IMPELLER	29	DRIVE SCREW
3	LOWER SEAL ASSEMBLY	30	STUD
4	UPPER SEAL ASSEMBLY	31	LOCKWASHER
5	SOCKET HEAD PIPE PLUG	32	HEX NUT
6	SEAL CAVITY DRAIN PLUG	33	TERMINAL HSG & CABLE ASSY
7	BEARING CAP	34	STATOR
8	HEX HEAD CAPSCREW	35	ROTOR & SHAFT ASSY
9	LOCKWASHER	36	LOWER BALL BEARING
10	LWR MOTOR HOUSING O-RING	37	LOWER MOTOR HOUSING
11	STATOR KEY	38	BEARING CAP O-RING
12	MOTOR HOUSING	39	HEX HEAD CAPSCREW
13	UPPER MOTOR HOUSING	40	LOCKWASHER
14	UPPER BALL BEARING	41	SEAL PLATE O-RING
15	MOTOR HOUSING O-RING	42	SEAL PLATE
16	IMP ADJUSTING SHIM SET	43	MOTOR HOUSING O-RING
17	RETAINING RING	44	IMPELLER WASHER
18	SPRING HOLDER	45	IMPELLER NUT
19	HEX HEAD CAPSCREW	46	STRAINER SUPPORT
20	LOCKWASHER	47	STRAINER ASSEMBLY
21	FLAT WASHER	48	STUD
22	BAIL BUSHING	49	LOCKWASHER
23	HOIST BAIL	50	HEX NUT
24	DISCH FLANGE GASKET	51	BASE PLATE
25	DISCHARGE FLANGE	52	IMPELLER KEY
26	STUD	53	HEX HEAD CAPSCREW
27	HEX NUT	54	LOCKWASHER

SECTION DRAWING

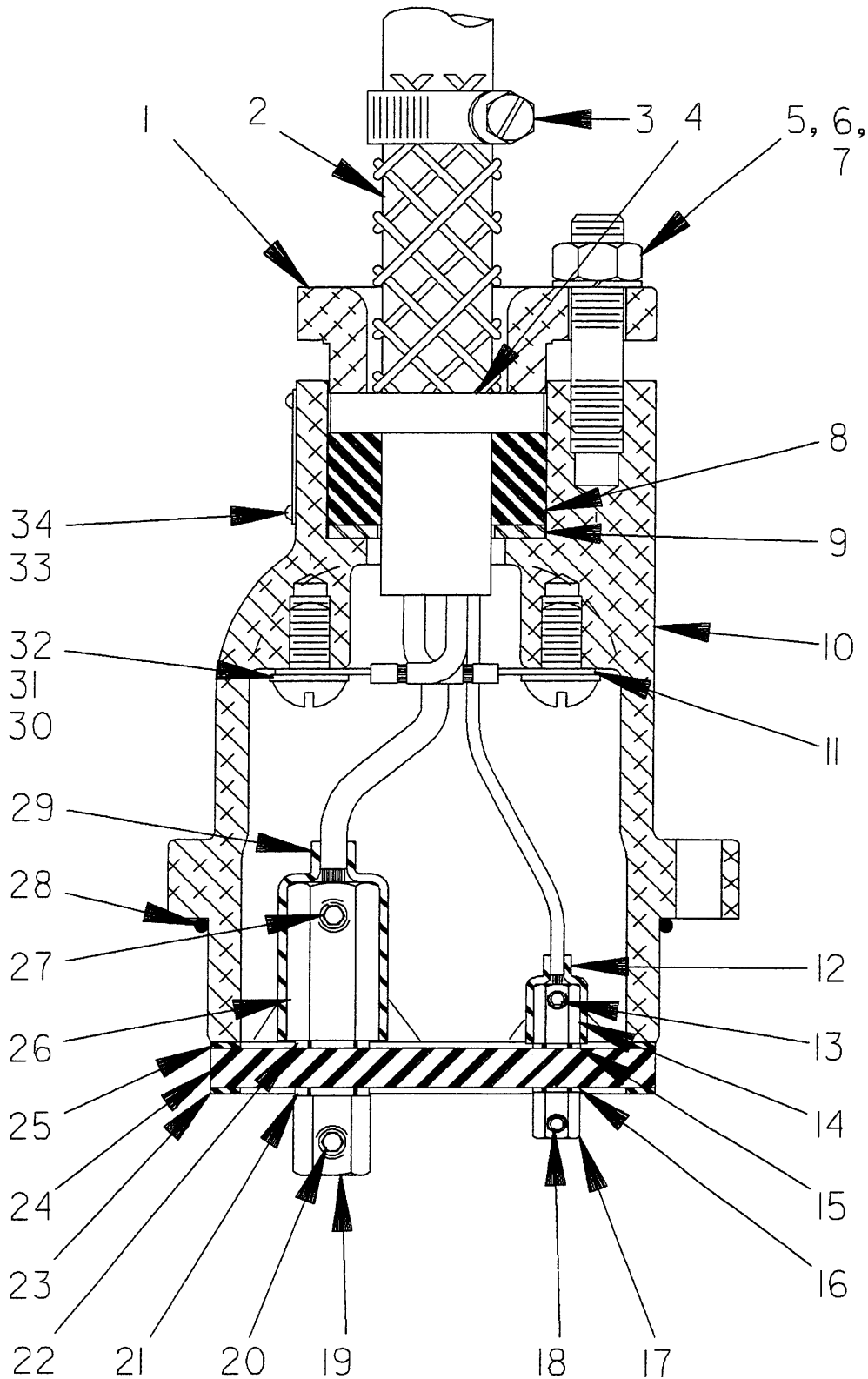

Figure C-2. SM4G's And SM4J's Terminal Housing & Cable Assembly

SM4G's And SM4J's Terminal Housing & Cable Assembly

Refer to the separate Parts List Manual for serviceable parts, part numbers and quantities.

ITEM NO.	PART NAME
1	TERMINAL GLAND
2	50 FT. CABLE ASSEMBLY
3	CABLE CLAMP
4	CABLE GRIP
5	STUD
6	HEX NUT
7	LOCKWASHER
8	GLAND BUSHING
9	TERMINAL WASHER
10	TERMINAL HOUSING
11	TERMINAL
12	HEAT SHRINK TUBE
13	ALLEN HEAD SETSCREW
14	TERMINAL COLLAR
15	DYNA SEAL WASHER
16	DYNA SEAL WASHER
17	TERMINAL POST
18	ALLEN HEAD SETSCREW
19	TERMINAL POST
20	ALLEN HEAD SETSCREW
21	DYNA SEAL WASHER
22	DYNA SEAL WASHER
23	LOWER TERMINAL PLATE GASKET
24	TERMINAL PLATE
25	UPPER TERMINAL PLATE GASKET
26	TERMINAL COLLAR
27	ALLEN HEAD SETSCREW
28	O-RING
29	HEAT-SHRINK TUBE
30	TERMINAL
31	ROUND HEAD MACHINE SCREW
32	T TYPE LOCKWASHER
33	DRIVE SCREW
34	CERTIFICATION PLATE

PUMP END DISASSEMBLY

References are to Figure C-1 and Figure C-2.

Review all SAFETY information in Section A.

Follow the instructions on all tags, label and decals attached to the pump.

All functions performed by the customer on the pump or control must be done in accordance with MSHA, schedule 2G regulations to ensure the explosion-proof integrity. No alterations of original design may be made without the consent of the Gorman-Rupp Company and MSHA.

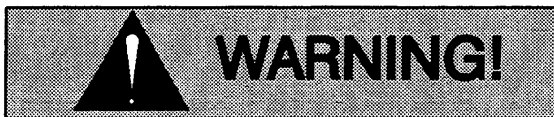

The electrical power used to operate this pump is high enough to cause injury or death. Make certain that the control handle on the control box is in the off position and locked out, or that the power supply to the control box has been otherwise cut off and locked out, before attempting to open or service the pump assembly. Tag electrical circuits to prevent accidental start-up.

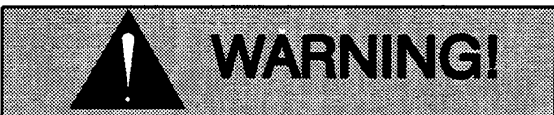

Do not open the control box in an explosive atmosphere. When sealed, the control box is explosion proof to prevent the ignition of combustible gases. Opening the box in an explosive atmosphere could result in fire or explosion.

Before attempting to service the pump or control, terminate the power supply to the control box. Close the discharge throttling valve, if so equipped.

Use the hoisting bail to remove the pump from the wet well or sump, and move it to a location where the discharge line can be removed. It is not necessary to disconnect a flexible discharge hose before

removing the pump. If rigid discharge piping is used, disconnect the piping before attempting to move the pump.

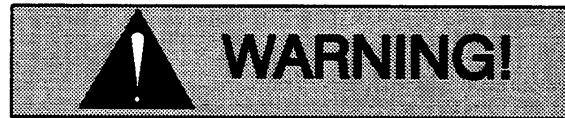

Do not attempt to lift the pump by the motor power cable or the piping. Attach proper lifting equipment to the lifting device fitted to the pump. If chains or cable are wrapped around the pump to lift it, make certain that they are positioned so as not to damage the pump, and so that the load will be balanced.

Select a suitable location, preferably indoors, to perform the degree of maintenance required. If the motor housing is to be opened, the work must be done in a clean, well-equipped shop. All maintenance functions must be done by qualified personnel.

Check the chart in **TROUBLESHOOTING**, Section B of this manual, to determine the nature of the pump problem. If the problem is mechanical in nature, such as worn pump parts, seal replacement, lubrication, etc., refer to **PUMP END DISASSEMBLY** for instructions.

If the problem is electrical, complete disassembly may not be required. Refer to **Electrical Testing** in **TROUBLESHOOTING**, Section B, and have a qualified electrician check the control box, cable and terminal housing. If the problem is determined to be in the motor, proceed with **PUMP END DISASSEMBLY**, followed by **MOTOR DISASSEMBLY**. Otherwise, see **Terminal Housing And Power Cable Disassembly**.

Carefully inspect any O-rings or gaskets before removal and cleaning to determine if a proper seal and compression existed prior to disassembly. If sealing was faulty or questionable, the cause must be determined and corrected before reassembly. All gaskets and most O-rings **must** be replaced if disturbed. Repair gaskets and O-rings are listed in the Parts List manual.

PUMP END DISASSEMBLY

Strainer Removal

(Figure C-1)

To remove the strainer (47), raise the pump slightly, or lay it on its side and disengage the hardware (49 and 50) securing the base plate (51). Remove the base plate, strainer, and supports (46). If the impeller (2) is clogged, the debris can usually be removed without further disassembly.

Draining Oil From Seal Cavity

(Figure C-2)

If any further disassembly is to be performed on the pump, the seal oil cavity must be drained.



Let the pump cool before removing the seal cavity drain plug. Pressure built up within a hot pump could cause the oil to spray out when the plug is removed. Remove the plug slowly and permit pressure to vent to atmosphere.

With the pump in a vertical position, clean any dirt from around the pipe plug (5) and remove it. Remove the seal cavity drain plug (6) and install a short 3/8 inch NPT nipple in the hole. Tip the pump and drain the seal oil into a clean container. Inspect the oil for water, dirt, or cloudy condition which could indicate lower seal failure or poor gasket seal.

Positioning Pump For Disassembly

(Figure C-1)

It is recommended that the pump be positioned upside-down during disassembly. To hold the pump in the inverted position, screw a pipe in the discharge flange (25) and clamp it in a large vise, or remove the discharge flange and secure the flange studs to a bench or work stand. Be careful not to damage the terminal housing and cable assembly (33) while in this position. Use adequate equip-

ment and personnel to safely handle the pump until it is secured. If inverting the pump is not practical, lay the pump on its side and secure it to prevent rolling.

Diffuser Removal

(Figure C-1)

To remove the diffuser (1), disengage the hardware (53 and 54) securing the diffuser to the seal plate (42) and lower motor housing (37). Remove the diffuser, and remove and discard the motor housing O-ring (43).

Impeller Removal

(Figure C-1)

Temporarily install two of the capscrews (53). Wedge a piece of wood between the vanes of the impeller (2) and the capscrews to prevent shaft rotation. Remove the impeller nut (45) and washer (44).

Remove the wood and the two capscrews. Install the impeller puller supplied with the pump, and pull the impeller from the shaft. Use caution when removing the impeller; tension on the seal spring will be released. Retain the impeller key (52).

Remove the impeller adjusting shim set (16). For ease of reassembly, tie and tag the shims or measure and record their thickness.

Lower Seal Removal

(Figures C-1 and C-3)

Remove the seal spring. Lubricate the shaft, and work oil up under the rubber bellows of the rotating portion of the seal. Carefully slide the rotating portion of the seal assembly off the shaft.

To remove the stationary portion of the seal, slide the seal plate (42) off the shaft. Remove and discard the seal plate O-ring (41).

Place a clean cloth on a flat surface and place the seal plate on the cloth with the impeller side down. Use a drift pin or screwdriver to press on alternate sides of the stationary seat until the stationary element and seat are removed.

The rotating and stationary seal elements are precision finished and subject to wear. The complete seal should be replaced with each overhaul to ensure trouble-free operation. However, if the old seal must be reused, wrap the seal faces individually in clean tissue paper to prevent damage to the sealing surfaces.

If no further disassembly is required, proceed to the appropriate areas in **PUMP END REASSEMBLY**.

Upper Seal Removal

(Figures C-1 And C-3)

Unless cracked, worn, or the O-ring (10) needs replacement, it is not necessary to remove the lower motor housing (37) to remove the upper seal assembly (4). If necessary to remove the lower motor housing, however, see the procedure under **Motor Disassembly** in this section. **Do not** attempt to loosen the hardware (39 and 40) securing the bearing cap (7) before referring to this section; otherwise, the rotor shaft and bearings could be damaged.

Remove the seal retaining ring (17) using snap ring pliers. Use caution when removing the retaining ring; tension of the seal spring will be released. Remove the seal spring holder (18) and spring. Lubricate the shaft adjacent to the seal, and work oil up under the rubber bellows. Position a screwdriver or other suitable device on each side of the bellows retaining flange, and pry the bellows upward until the rotating portion is off the shaft.

Slide the hooked ends of two wires along the shaft and under the stationary seal seat. Hook the back side of the seal, and pull the seat and stationary element from the lower motor housing.

With the pump inverted, stuff a clean tissue into the seal bore of the lower motor housing (or wrap a small rag around the shaft) to prevent contamination or foreign material from entering the motor cavity.

NOTE

*If the motor housing components are to be serviced, see **MOTOR DISASSEMBLY** in this section. Do not reassemble the pump end components at*

this time.

If no further disassembly is required, proceed to **PUMP END REASSEMBLY**.

PUMP END REASSEMBLY

NOTE

Reuse of old O-rings, gaskets, or shaft seal parts will result in premature leakage or reduced pump performance. It is strongly recommended that new gaskets and shaft seal assemblies be used during reassembly (see the parts lists for numbers).

Cleaning And Inspection Of Pump Parts

(Figure C-1)

Carefully inspect any O-rings or gaskets before removal and cleaning to determine if a proper seal and compression existed prior to disassembly. If sealing was faulty or questionable, the cause must be determined and corrected before reassembly. Replace any parts as required.

Thoroughly clean all reusable parts with a soft cloth soaked in cleaning solvent. Use a clean cloth lightly dampened with solvent to clean the lower end of the motor housing, intermediate, and seal plate. **Do not** allow the solvent to enter the motor.



Most cleaning solvents are toxic and flammable. Use them only in a well ventilated area free from excessive heat, sparks, and flame. Read and follow all precautions printed on solvent containers.

Remove all O-rings, and clean the sealing surfaces of dirt. Be careful not to scratch the surfaces.

Inspect the rotor shaft for damaged threads, scoring, or nicks. Remove nicks and burrs with a fine file or emery cloth to restore original contours. If the shaft is bent or severely damaged, the rotor and shaft must be replaced as an assembly (see **MOTOR DISASSEMBLY**).

Seal Installation

(Figures C-1 and C-3)

Neither of the shaft seal assemblies should be reused because wear patterns on the finished faces cannot be realigned during assembly. This could result in premature failure. If necessary to reuse an old seal in an emergency, **carefully** wash all metallic parts in fresh cleaning solvent and allow to dry thoroughly.

Handle the seal parts with extreme care to prevent damage. Be careful not to contaminate the precision finished faces; even fingerprints on the faces can shorten seal life. If necessary, clean the faces with a non-oil based solvent and a clean, lint-free

tissue. Wipe **lightly** in a circular pattern to avoid scratching the faces.

Inspect the seal components for wear, scoring, grooves, and other damage that might cause leakage. If any components are worn, replace the complete seal; **never mix old and new seal parts.**

If a **new** seal is to be installed, do not unwrap it until time of installation. Cleanliness of seal components is critical, especially the seal faces.

Clean the rotor shaft and seal cavity area of the lower motor housing. Be sure the area is dry and free of lint and dirt. **Do not** permit cleaning solvent or debris to fall into the motor cavity.

Install the shaft seals as illustrated in Figure C-3.

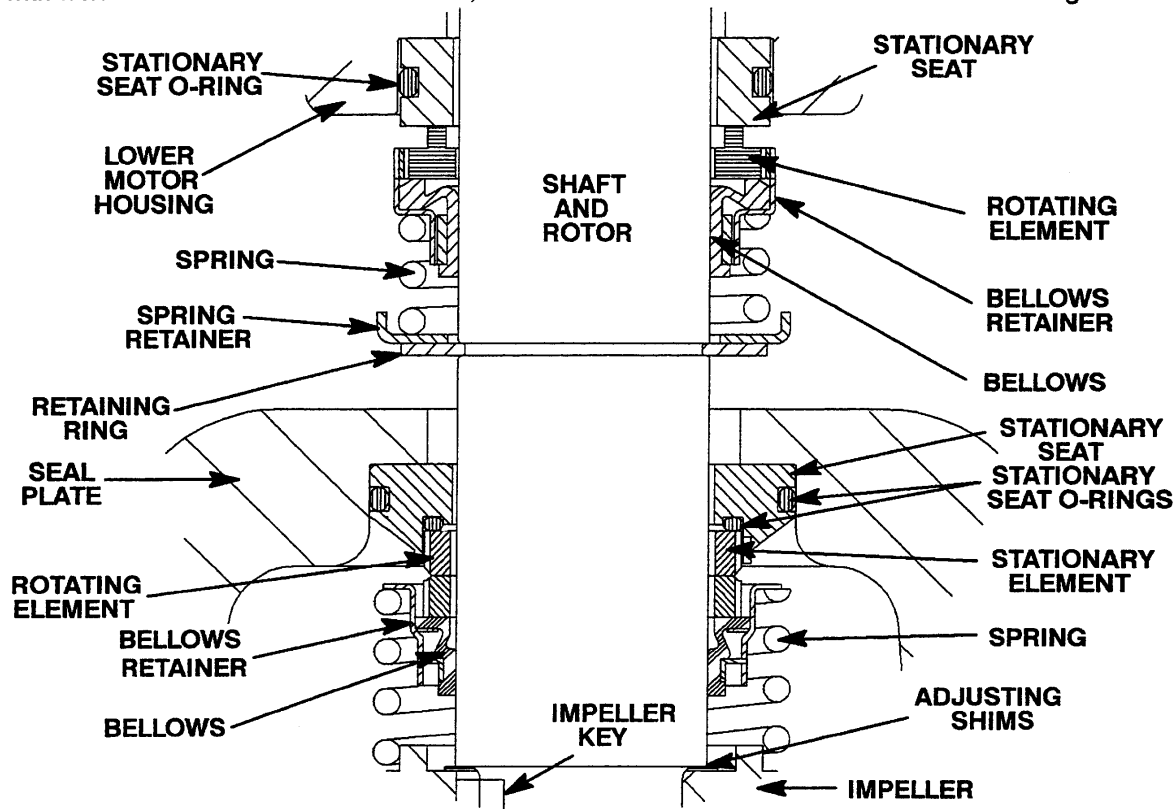
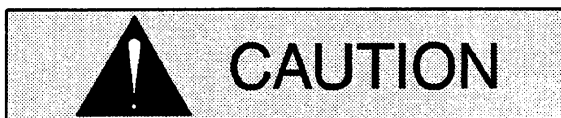

Figure C-3. Upper And Lower Seal Assemblies



This seal is not designed for operation at temperatures above 160° F (71° C). Do not use at higher operating temperatures.

Upper Seal Installation

(Figures C-1 and C-3)

If a **new** upper seal assembly is to be installed, do not unwrap it until time of installation. Cleanliness of seal components is critical, especially the seal faces.

Carefully remove the material stuffed into the seat bore (or unwrap the shaft). **Be sure** no debris stopped by the material falls into the motor cavity.

Clean the rotor shaft and seal cavity area of the lower motor housing. Be sure the area is dry and free of lint and dirt. **Do not** permit cleaning solvent or debris to fall into the motor cavity. Check the seal bore for burrs or nicks that might prevent a good seal. Apply a **light** coating of oil to the bore.

Unpack the stationary seat and element. Apply a **light** coating of oil to the stationary seat. Keep the sealing face dry.

NOTE

When pressing seal components onto the impeller shaft, use hand pressure only. A push tube cut from a length of plastic pipe will aid in installing seal components. The I.D. of the push tube should be approximately the same as the I.D. of the seal spring.

Position the seat in the bore with the sealing face up, and cover it with a clean tissue. Use your thumbs to press the seal into the bore. Apply equal pressure on opposite sides of the seat until it is fully seated in the bore. Remove the tissue and inspect the seal face to ensure that it is clean and dry. If cleaning is necessary, use clean tissue to wipe **lightly** in a circular pattern.

Unpack the rotating portion of the seal. Be certain the seal face of the rotating element is free of grit or surface damage. Place a **small** amount of grease at equal spaces on the back of the element, and assemble the drive grooves of the rotating element into the drive lugs of the bellows retainer. The grease should hold the element in position until the seal is installed.

Apply a light coating of oil to the seal seating surface on the shaft, the groove for the retaining ring (17), and the I.D. of the bellows. Apply a single drop of **light** lubricating oil to the precision-finished seal face. Position the rotating seal portion on the shaft with the seal face down. Apply firm, steady pressure on the bellows retainer until it slides down the shaft and the seal faces contact. This step should be done in one continuous motion to prevent the bellows from sticking or rolling as it passes over the retaining ring groove.

Slide the seal spring over the shaft and bellows retainer, and install the spring holder (18). Install the seal retaining ring (17). See Figure C-3 for proper order of seal assembly.

Lower Seal Installation (Figures C-1 And C-3)

Thoroughly clean the sealing surfaces and seal bore of the the seal plate (42). The seal bore must be free of burrs and nicks which could damage the seal.

NOTE

When pressing seal components onto the impeller shaft, use hand pressure only. A push tube cut from a length of plastic pipe will aid in installing seal components. The I.D. of the push tube should be approximately the same as the I.D. of the seal spring.

Unpack the stationary seat, and check that the O-rings are properly installed. Press the stationary element into the seat, making sure that the grooves in the element engage the lugs on the seat. Apply a **light** coating of oil to the stationary seat. Keep the sealing face dry.

Position the seal plate on a flat surface with the impeller side up. Position the seat in the bore with the sealing face up, and cover it with a clean tissue. Use your thumbs to press the seal into the bore. Apply equal pressure on opposite sides of the sealing element until it is fully seated in the bore. Remove the tissue and inspect the seal face to ensure that it is clean and dry. If cleaning is necessary, use clean tissue to wipe **lightly** in a circular pattern.

Lubricate the O-ring (41) with light oil, and install it on the seal plate shoulder. Carefully position the seal plate and assembled stationary portion of the seal over the shaft and press the seal plate into the lower motor housing (37) until fully seated. **Be careful** not to damage the stationary element.

Unpack the rotating portion of the seal. Be certain the seal face of the rotating element is free of grit or surface damage. Place a **small** amount of grease at equal spaces on the back of the element, and assemble the drive grooves of the rotating element into the drive lugs of the bellows retainer. The grease should hold the element in position until the seal is installed.

Apply a light coating of oil on the I.D. of the bellows and the rotor shaft. Apply a single drop of **light** lubricating oil to the precision-finished seal face. Position the rotating seal portion on the shaft with the seal face down. Apply firm, steady pressure on the bellows retainer until it slides down the shaft and the seal faces contact.

Slide the seal spring over the shaft and bellows retainer. See Figure C-3 for proper order of seal assembly.

Impeller Installation

(Figure C-1)

Inspect the impeller (1) for cracks, broken vanes, or wear from erosion, and replace it if damaged. Clean the threads on the rotor shaft to remove any old thread locking material.

Install the same thickness of impeller adjusting shims (16) as previously removed. Install the impeller key (52) in the shaft keyway, align the impeller keyway, and press the impeller onto the shaft until it seats firmly against the adjusting shims. Be sure the seal spring seats squarely over the shoulder on the back of the impeller.

For maximum pump efficiency, there should be a clearance of .010 to .015 inch (0,3 to 0,4 mm) between the diffuser and the face of the impeller. The impeller must be fully seated on the shaft to determine this clearance. Install the impeller washer and nut (52 and 45). Install two capscrews (53) in the seal plate and diffuser. Wedge a block of wood between the impeller vanes and capscrews to prevent shaft rotation, and torque the impeller locknut to 120 ft. lbs. (1440 in. lbs. or 16,6 m. kg.) for SM4G's or 175 ft. lbs. (2100 in. lbs. or 24,2 m. kg.) for the SM4J's. Install the diffuser as follows, and check the impeller clearance.

Diffuser Installation

(Figure C-1)

Inspect the diffuser (1) and replace it if damaged. Remove the capscrews (53), and position the diffuser against the seal plate. Reach through the diffuser opening with a feeler gauge and measure the impeller face clearance.

Adjust the clearance by removing the impeller nut and washer and adding or removing adjusting shims (16) as required.

When the impeller is properly positioned, reinstall the capscrews (53) and wood block to secure the impeller to prevent rotation. Coat the threads of the rotor shaft with 'Loctite Threadlocker No. 242' or equivalent compound, install the impeller washer and re-torque the impeller nut (45).

NOTE

After the impeller has been properly positioned, check for free rotation. Correct any scraping or binding before further reassembly.

Install the O-ring (43) on the diffuser. Apply 'Loctite threadlocker No. 242' or equivalent compound to the threads of the capscrews (53) and secure the diffuser to the seal plate and lower motor housing (37) with the hardware (53 and 54). Torque the capscrews to 120 ft. lbs. (1440 in. lbs. or 16,6 m. kg.) for SM4G's or 175 ft. lbs. (2100 in. lbs. or 24,2 m. kg.) for SM4J's.

Strainer Installation

(Figure C-1)

Inspect the strainer screen (47) for cracks, distortion or broken welds. Straighten, reweld or replace it if defective.

Install the strainer supports (46) and strainer (47). Install the base plate (51) over the studs (48), and secure it with the hardware (49 and 50). Tighten the nuts just enough to draw the strainer screen down tightly, but not tight enough to distort it.

See **LUBRICATION** and **FINAL ASSEMBLY** before putting the pump back into service.

MOTOR DISASSEMBLY

Disassembly of the motor is rarely required except to replace the motor rotor, stator or bearings. Do not disassemble the motor unless it is necessary and a clean, well-equipped shop is available.

NOTE

It is recommended that a pump with a defective motor be returned to Gorman-Rupp, or to one of the

Gorman-Rupp authorized Submersible Repair Centers.



Motor repairs **must be** performed in accordance with MSHA specifications regarding the permissibility of this equipment. Refer to **Installation And Operation** manual.

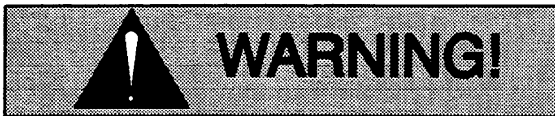

The electrical power used to operate this pump is high enough to cause injury or death. Make certain that the control handle on the control box is in the **off** position and locked out, or that the power supply to the control box has been otherwise cut off and locked out, before attempting to open or service the pump assembly. Tag electrical circuits to prevent accidental start-up.



Do not remove the control box cover in an explosive atmosphere. When sealed, the control box is explosion proof to prevent the ignition of combustible gases. Opening the box in an explosive atmosphere could cause fire or explosion.

Carefully inspect any O-rings or gaskets before removal and cleaning to determine if a proper seal and compression existed prior to disassembly. If sealing was faulty or questionable, the cause must be determined and corrected before reassembly. Replace any parts as required.

Terminal Housing And Power Cable Removal And Disassembly

(Figure C-1)

Total disassembly of the terminal housing and power cable assembly (33) is not always required.

Disassemble and replace **only** the parts proven defective by inspection or testing. See **Electrical Testing** in TROUBLESHOOTING.

The terminal housing and power cable assembly may be serviced without disassembling the motor housing or pump end, or without draining the oil from the seal cavity. However, the oil **must** be drained before attempting to disassemble the motor housing and components.

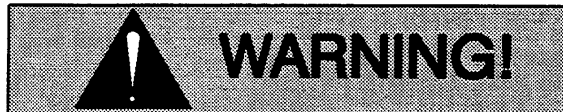

Do not remove the terminal housing in an explosive atmosphere. The terminal housing and its O-ring must remain intact to retain the permissibility of this equipment. Removing the housing in an explosive atmosphere could cause fire or explosion.

Secure the pump in an upright position. Remove the hardware (31 and 32) securing the terminal housing assembly to the motor housing (13).

(Figure C-2)

Carefully raise the terminal housing from the motor housing until the terminal posts (17 and 19) are accessible. Loosen the allen head setscrews (18 and 20), and disconnect the motor leads from the terminal posts. Separate the terminal housing and power cable assembly from the motor housing. Remove the lower terminal housing gasket (23).

Remove the O-ring (28) from the terminal housing. No further disassembly is required to test the stator or power cable.

To remove the power cable (2) and grip (4), remove the clamp (3). Disengage the hardware (6 and 7), and slide the terminal gland (1) back along the power cable.

Compress the wire mesh of the cable grip and move it back along the power cable. Oil the gland bushing (8) and terminal housing bore and push firmly on the cable. (Allow the oil to leak in around the bushing by agitating the cable in the bore.) After the bushing has been loosened, it should be possible to push the cable into the terminal housing so that the terminal plate (24) comes free of the

terminal housing. This should permit access to the power cable connections in the terminal plate.

NOTE

Sometimes pressure exerted on the gland bushing (8) will deform the power cable jacket. If this occurs, additional oil and effort will usually free the power cable. If the cable cannot be separated from the gland bushing, it may be necessary to cut the cable.

The connections between the power cable leads and the terminal collars (14 and 26) were encapsulated in heat-shrink tubing (12 and 29) and bonded to the terminal plate with silicone adhesive. Cut away the tubing and adhesive, and loosen the allen head setscrews (13 and 27). Disconnect the power cable leads from the terminal collars, and separate the terminal plate from the terminal housing (10). Remove the upper terminal plate gasket (25).

To remove the power cable from the terminal housing, disengage the hardware (31 and 32), and disconnect the green and yellow leads from the terminal housing. Slide the power cable out of the terminal housing. The terminal gland (1) and cable grip (4) can now be removed from the cable.

To remove the gland bushing (8), work oil in around the bushing. Invert the terminal housing, and press the bushing and terminal washer (9) out of the bore from the back side.

NOTE

If the rubber bushing cannot be removed from the terminal housing as indicated, it may be necessary to cut the bushing into small pieces.

If it is necessary to replace the terminal plate (24) or terminal components, unscrew the terminal collars (14 and 26), and remove the collars, dyna seal washers (15, 16, 21 and 22), and terminal posts (17 and 19).

See **Terminal Housing And Power Cable Reassembly** if no further disassembly is required.

Shaft And Rotor Removal

(Figure C-1)

See **PUMP END DISASSEMBLY**, and remove all pump end and seal components (including the lower motor housing).

To facilitate disassembly, disengage the hardware (19, 20, 21 and 22), and remove the hoisting bail (23) from the motor housing. With the pump end disassembled and the terminal housing removed, secure the pump in an inverted position.

Carefully slide the motor housing (12) off the upper and lower motor housings (13 and 37). Remove the motor housing O-ring (15).

Remove the hardware (8 and 9) securing the upper and lower motor housings (13 and 37) together. **Do not** remove the hardware (39 and 40) around the rotor shaft.

Install three 5/8-11 UNC lifting eyes (not supplied) in the tapped holes for the capscrews (53) in the lower motor housing, and hook a three-leg sling to the lifting eyes. Use a suitable hoist to support the pump.

Install two 3/8-16 UNC by 3-inch long capscrews (not supplied) in the jacking holes in the lower motor housing. Use the capscrews to jack the lower motor housing, rotor and shaft assembly (35), bearing cap (7), and both ball bearings (14 and 36) from the upper motor housing as an assembly. If necessary, tap around the parting surfaces with a soft-faced mallet to break the seal between the upper and lower motor housings. Remove the lower motor housing O-ring (10). Remove the jacking screws from the lower motor housing.

Cover the upper motor housing with a clean, lint-free cloth to avoid contamination by dirt or other foreign material.

Set the lower motor housing and rotor assembly on a clean work area. Remove the hardware (39 and 40) securing the bearing cap (7) to the lower motor housing.

Steady the rotor and shaft assembly, and separate the lower motor housing. If necessary, tap the impeller end of the rotor shaft with a soft-faced mallet to loosen the seal between the bearing cap and the lower motor housing. Remove the O-rings (38) from the bearing cap.

Bearing Removal

(Figure C-1)



To prevent damage during removal from the shaft, it is recommended that bearings be cleaned and inspected **in place**. It is **strongly** recommended that the bearings be replaced **any** time the shaft and rotor assembly is removed.

Before removing the bearings from the rotor shaft, clean and inspect the bearings **in place** as follows.

Clean the bearings thoroughly in **fresh** cleaning solvent. Dry the bearings with filtered compressed air and coat with light oil.

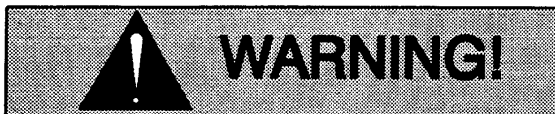

Most cleaning solvents are toxic and flammable. Use them only in a well ventilated area; free from excessive heat, sparks, and flame. Read and follow all precautions printed on solvent containers.

Rotate the bearings by hand to check for roughness or binding. If rotation is rough, replace the bearings.

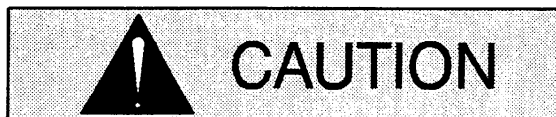

These bearings are permanently sealed and require no additional lubrication except a coating of light oil on external surfaces to ease reassembly. External surfaces must be kept free of all dirt and foreign material. Failure to do so could damage the bearings or their mating surfaces.

The bearing tolerances provide a tight press fit onto the shaft and a snug slip fit into the motor housing and bearing bore. Replace the shaft and rotor (as an assembly), bearing cap or the upper

motor housing if the proper bearing fit is not achieved.

If the bearings require replacement, use a suitable puller to remove the upper bearing (14) from the shaft. Use the bearing cap and capscrews (39) in conjunction with the bearing puller to remove the lower bearing (36) from the shaft. Press the lower bearing out of the bearing cap.

If no further disassembly is required, cover the middle and upper motor housings with a clean, lint-free cloth to avoid contamination of the stator by dirt or other foreign material.

Stator Removal

(Figure C-1)

Do not remove the stator (34) unless it is defective (open windings, insulation resistance low, or stator core damaged). If the stator must be removed, remove the terminal housing as indicated in **Terminal Housing And Power Cable Disassembly**.

With the pump end, lower motor housing, and rotor removed, position an expandable tool, such as a split disc, approximately 2 inches (51 mm) down inside the stator, and expand it tightly and squarely on the I.D. Attach a lifting device to the lifting eye of the tool, and raise the assembly approximately 1 inch (25 mm) off the work surface. Take care not to damage the stator end turns.

The motor housing must be heated with a torch to expand it enough for the stator to be removed. Apply heat evenly to the outside of the motor housing; excessive heat is not required. When the motor housing is sufficiently heated, use a soft-faced mallet to rap alternate edges of the upper motor housing, and "walk" the stator out. Continue this process until the stator clears the motor housing.

When the stator is free of the motor housing, remove the key (11). Wrap the stator in clean, dry rags or other suitable material until reassembly. The stator **must** be kept clean and dry. When handling the stator, **do not** set it on the end windings; lay it on its side.



Do not attempt to rewind the stator. Wind-

ing tolerances and materials are closely controlled by the manufacturer, and any deviation can cause damage or operating problems. Replace the stator, or return it to one of The Gorman-Rupp Authorized Submersible Repair Centers or The Gorman-Rupp factory, if defective.

MOTOR REASSEMBLY



Do not attempt to rewind the stator. Winding tolerances and materials are closely controlled by the manufacturer, and any deviation can cause damage or operating problems. Replace the stator, or return it to one of The Gorman-Rupp Authorized Submersible Repair Centers or The Gorman-Rupp factory, if defective.

NOTE

Reuse of old O-rings, gaskets, shaft seal parts will result in premature leakage or reduce pump performance. It is strongly recommended that new gaskets and shaft seal assemblies be used during reassembly (see the parts lists for numbers).

Stator Installation

(Figure C-2)

NOTE

Stator installation involves heating the upper motor housing and the application of insulating paint to the stator O.D. Both processes must be done quickly and at approximately the same time to allow the stator to slide into the motor housing before the paint dries or the housing cools. Therefore it is recommended that these steps be performed by two people to promote efficient installation of the stator.

Clean all O-ring surfaces, completely removing any material. Inspect the sealing surfaces for burrs, nicks and pits which could cause a poor seal, and replace defective parts as required.

Thoroughly clean the inside of the motor housings (13 and 37) with fresh solvent. The interior **must** be dry and free of dirt or lint.

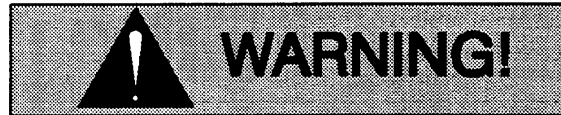

Most cleaning solvents are toxic and flammable. Use them only in a well ventilated area; free from excessive heat, sparks, and flame. Read and follow all precautions printed on solvent containers.

NOTE

When assembled at the factory, the stator was painted with insulating paint prior to installation in the motor housing. It may be necessary to use steel wool or a wire brush to remove excess paint from the I.D. of the motor housing before reassembly.

After the motor housings are thoroughly cleaned, position them on a flat surface with the discharge end down. Do not unwrap the stator (34) until the motor housing has been prepared for stator installation. The stator **must** be kept clean and dry. When handling the stator, do not set it on the end windings; lay it on its side and block it from rolling.

Test the new stator as indicated in **Electrical Testing** in **TROUBLESHOOTING**, Section B, to ensure that no damage has occurred during transit or handling.

NOTE

Remove any drops of varnish from the ends of the stator before installation to ensure proper stack-up height when assembled.

Position an expandable tool, such as a split disc, approximately 2 inches (51 mm) down inside the stator (opposite the lead wire end), and expand it tightly and squarely on the I.D. Attach a lifting device to the lifting eye of the tool, and carefully lift the assembly. Take care not to damage the stator end turns. Slip a sleeve over the stator leads, or tape them together to protect them during installation.

Stator installation involves heating the upper motor housing and the application of insulating paint to

the stator O.D. Both processes must be done quickly and at approximately the same time to allow the stator to slide into the motor housing before the paint dries or the housing cools.

Heat the upper motor housing with a torch to expand it enough for the stator to be installed; when heating the motor housing, **make sure** that the stator is clear to avoid a fire hazard, or damage to the windings. Apply heat evenly to the outside of the housing; excessive heat is not required.

While the motor housing is being heated, another person should paint the stator O.D. with insulating paint. With the stator suspended, apply a **very thin** coat of "General Electric Glyptol Red Insulating Paint" (G.E. P/N 1201) to the stator O.D. The paint is fast drying, so it must be applied quickly.

When the motor housing is sufficiently heated and the stator painted, position the stator so that the leads are in line with the terminal opening. Install the key (11), and carefully lower the stator into the motor housing until fully seated against the housing shoulder. Be careful not to damage the stator lead insulation during reassembly. If the stator "cocks" in the motor housing, remove it and try again.

After the stator is fully and squarely seated on the upper motor housing shoulder, remove the expandable disc tool and untape or remove the protective sleeve from the stator leads.

NOTE

Because of the tight shrink fit between the stator and upper motor housing, excess paint will be forced out as the stator is installed. Use soft rags to absorb any paint that accumulates between the stator and the housing, then use paint thinned to thoroughly clean the housing I.D.

Cover the motor housing with a clean, lint-free cloth while the rotor is being assembled.

Bearing Installation

(Figure C-1)

Inspect the rotor shaft (35) for damaged threads, scoring in the seal area, and a nicked or damaged keyway. If the bearings were removed, inspect the bearing areas for scoring or galling. Remove nicks

and burrs with a fine file or emery cloth. Inspect the rotor area for separated laminations. If the shaft is bent or damaged, or if the laminations are separated, replace the shaft and rotor (a single assembly).

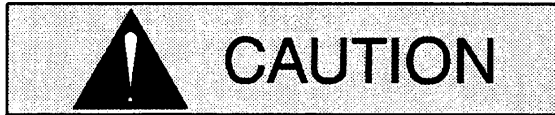

To prevent damage during removal from the shaft, it is recommended that bearings be cleaned and inspected **in place**. It is **strongly** recommended that the bearings be replaced **any** time the shaft and rotor assembly is removed.

The bearings may be heated to ease installation. An induction heater, hot oil bath, electric oven, or hot plate may be used to heat the bearings. Bearings should **never** be heated with a direct flame or directly on a hot plate.

NOTE

*If a hot oil bath is used to heat the bearings, both the oil and the container must be **absolutely** clean. If the oil has been previously used, it must be **thoroughly** filtered.*

Heat the bearings (14 and 36) to a uniform temperature **no higher than** 250°F (120°C). Slide the upper bearing onto the shaft until it is fully seated against the shaft shoulder. This should be done quickly, in one continuous motion, to prevent the bearing from cooling and sticking on the shaft.

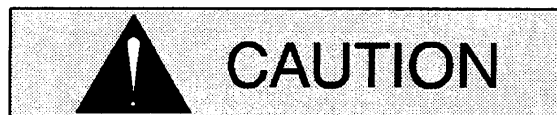

Use caution when handling hot bearings to prevent burns.

Clean the bearing cap (7), and apply 'Loctite Retaining Compound No. 609' to the O.D. of the bearing (36) and the I.D. of the bearing cap. Press the bearing into the cap until fully seated.

NOTE

Position the lower bearing (36) on the shaft as indicated by the following illustration.

INSTALLATION OF SKF 5200 AND 5300 SERIES BEARINGS

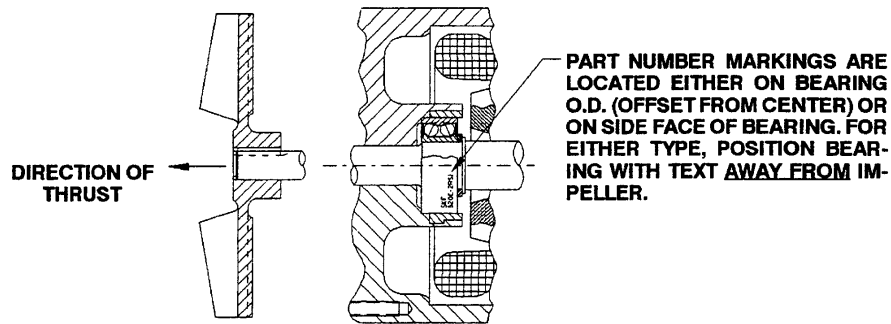

NOTE:
THIS BEARING IS MANUFACTURED WITH TWO SEALS OR SHIELDS. WHEN INSTALLED ON THE SHAFT, THE MANUFACTURER'S PART NUMBER DESCRIPTION (LOCATED ON SIDE FACE OF BEARING OR BEARING O.D.) MUST BE LOCATED WITH THE TEXT AWAY FROM THE IMPELLER.

Figure C-4. Bearing Installation

If a hot oil bath is used to heat the bearings, heat **both** the bearing and the cap, and slide the parts onto the shaft until the bearing seats squarely against the shaft shoulder. If an induction heater is used, heat **only** the inner race, and **do not** heat the bearing cap.

After the bearings have been installed and allowed to cool, check to ensure that they have not moved out of position in shrinking. If movement has occurred, use a suitably sized sleeve and a press to reposition the bearings. Make certain that they are seated squarely against the shaft shoulders.

If heating the bearings is not practical, use a suitably sized sleeve and an arbor (or hydraulic) press to install the bearings on the shaft.



When installing the bearings onto the shaft, **never** press or hit against the outer race, balls, or ball cage. Press **only** on the inner race.

Shaft And Rotor Installation

(Figure C-1)

Use **fresh** solvent to clean the bearing seating bore of the upper motor housing (13). Carefully lower the assembled shaft, rotor, bearings and bearing cap into the upper motor housing until the upper bearing is fully seated. Install the O-rings (38) on the bearing cap.

Install the O-ring (10) on the lower motor housing. Slide the lower housing over the shaft until it is fully seated in the upper housing. **Be sure** to align the tapped holes in the bearing cap with the holes for the capscrews (39). Apply 'Never-Seez' or equivalent compound on the threads of the capscrews (39), install the lockwashers (40), and secure the bearing cap to the lower motor housing by torquing the capscrews to 20 ft. lbs. (240 in. lbs. or 2,8 m. kg.).

Apply 'Never-Seez' or equivalent compound on the threads of the capscrews (8), and secure the upper and lower motor housings with the hardware (8 and 9). Torque the capscrews to 120 ft. lbs. (1440 in. lbs. or 16,6 m. kg.).

Install the O-ring (15) on the upper motor housing shoulder, and position the motor housing (12) over the upper and lower motor housings. Be careful not to damage the O-ring, and make sure the pipe plugs (5 and 6) are aligned.

Refer to **PUMP END REASSEMBLY**, and reassemble the pump end components.

Terminal Housing And Power Cable Preparation

(Figure C-2)



The electrical power used to operate this pump is high enough to cause injury or death. Make certain that the control

handle on the control box is in the **off** position and locked out, or that the power supply to the control box has been otherwise cut off and locked out, before attempting to open or service the pump assembly. Tag electrical circuits to prevent accidental startup. Obtain the services of a qualified electrician to make electrical connections.

Clean the exterior of the power cable with warm water and mild detergent. Check for obvious physical damage. Check the cable for continuity and insulation resistance (see **Electrical Testing in TROUBLESHOOTING**). Do not attempt repairs except to cut off either end of the cable; **splicing is not recommended**. Reinstall any wire tags or terminals which may have been removed.

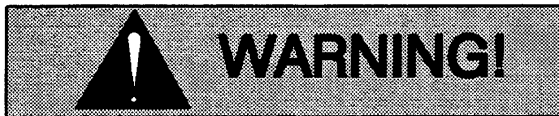

Never attempt to alter the length or repair any power cable with a splice. The pump motor and cable must be completely waterproof. Injury or death may result from alterations.

Use oil to lightly lubricate the outside of the pump power cable (2), the rubber gland bushing (8), and the bores of the terminal gland (1) and cable grip (4) for ease of assembly. Slide the terminal gland onto the power cable. Compress the wire mesh on the cable grip, and slide it onto the cable, allowing approximately 1 ft. of cable to extend beyond the mesh. Slide the rubber cable grip bushing and washer (9) onto the cable. Temporarily tape the ground wires (green and yellow) to the cable.

Sealing Terminal Housing Connections

(Figure C-2)

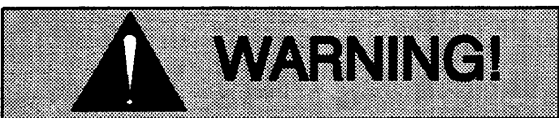

Do not attempt to operate this pump unless the power cable leads are properly sealed in the terminal housing. Moisture entering the terminal housing

could cause a short circuit, resulting in pump damage and possible serious injury or death to personnel.

If the power cable leads were removed from the terminal collars (14 and 26), the connections **must** be resealed.

When shipped from the factory, the cable leads and terminal collars (14 and 26) were encapsulated in heat-shrink tubing (12 and 29), and bonded to the terminal plate (24) with silicone adhesive to provide a water-tight seal. If this insulating material has been damaged or removed during maintenance, **it must** be replaced using materials and equipment approved by Gorman-Rupp (see the parts list for part numbers).

NOTE

*Use **only** materials approved by Gorman-Rupp for field repairs.*

Remove all the old tubing material from the terminal collars (14 and 26) and terminal plate (24). Inspect all parts for damage, and replace as required.

NOTE

Clean the cable leads and terminal plate in the areas to be sealed with cleaning solvent.

Assemble the terminal posts, dyna seal washers, and terminal collars to the terminal plate as shown in Figure C-2.

Slide the upper terminal plate gasket up over the power cable leads.

NOTE

Both the power cable and motor conductor leads should be tinned prior to reassembly.

Slide a length of heat-shrink tubing up over each of the power cable leads. Insert the standard power cable leads into the large terminal collars (26), and secure them with the setscrews (27). Insert the two control leads into the small terminal collars (14) and secure them with the setscrews (13). See Figure C-5 for wiring connections.

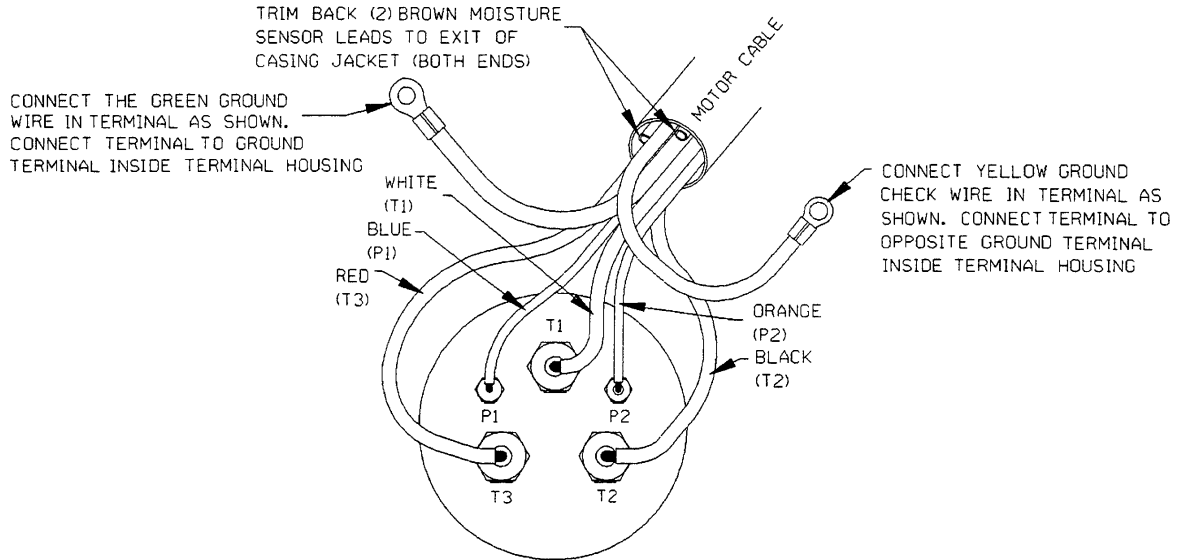

Figure C-5. Terminal Housing Wiring Connections

Slide the heat-shrink tubes down over the collars until they contact the terminal plate. The tubing **must** extend up the leads far enough to ensure a good seal. Carefully heat each tube with a torch or commercial hot air gun capable of producing 750°F (399°C), and shrink it around the cable leads, terminal posts, and collars.

After the tubing has shrunk and set, apply the silicone adhesive around the power cable leads. The terminal collars and power cable leads must be **totally sealed** against moisture.

NOTE

Do not use a mold or reservoir with the silicone adhesive.

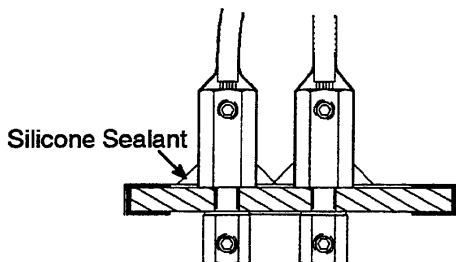

Figure C-6. Silicone Adhesive Sealing

See Figure C-5 and check terminal locations. Apply a 1/4 to 3/8 in. (6,4 to 9,7 mm) thick layer (maximum) of silicone adhesive around each of the ter-

terminal posts as shown in Figure C-6. Remove any adhesive from gasketed surfaces.



All air pockets, voids or gaps in the silicone sealant must be removed to ensure a water-tight seal in the terminal housing. Otherwise, moisture entering the terminal housing could cause a short circuit, resulting in pump damage and possible serious injury or death to personnel.

Allow the adhesive to cure for at least one hour before securing the terminal housing to the motor housing.

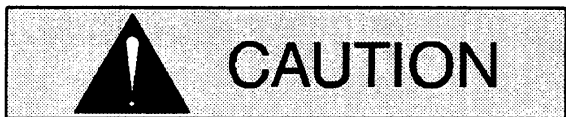

Use **only** Dow-Corning 737 Silicone Adhesive (see the Parts List Manual for the part number) for sealing terminal housing connections. Use of unapproved sealing products will void the pump warranty.

Terminal Housing Reassembly

(Figure C-2)

After the heat-shrink tubing has been installed, untape the ground leads, and slide the upper terminal

plate gasket (25) and terminal housing (10) down the cable. If removed, connect the green ground lead to the ground terminal (30), and connect the yellow ground check lead to the ground check terminal (11).

Secure the terminals to the terminal housing with the hardware (31 and 32); **be sure** the terminals make good contact with the housing.

Pull gently on the power cable to remove any excess length from within the terminal housing. The terminal plate should fit loosely against the terminal housing.

Slide the terminal washer (9) down the cable and into the upper bore of the terminal housing. Oil the bore and cable, and slide the gland bushing (8) into place. Compress the wire mesh of the cable grip (4), and slide it down the cable, making sure it contacts the bushing. Slide the terminal gland (1) into place, and engage the hardware (6 and 7) finger tight. Do not fully tighten the nuts at this time.

Install the terminal housing O-ring (28) on the terminal housing. Position the lower gasket (23) against the terminal plate, then attach the motor leads to the terminal posts (17 and 19) using the setscrews (18 and 20).

NOTE

A small amount of gasket adhesive may be used to hold the upper and lower terminal plate gaskets in place to ease assembly.

If required, rotate the terminal housing and twist the motor leads to remove excess slack. Coat the threads of the terminal housing studs (30, Figure C-1) with 'Never-Seez' or equivalent compound, and secure the terminal housing assembly to the motor housing with the hardware (31 and 32, Figure C-1); torque the nuts to 20 ft. lbs. (240 in. lbs. or 2,8 m. kg.).

Tighten the hardware (6 and 7), drawing the terminal gland down into the terminal bore. **Do not** over-tighten and damage the terminal gland or hardware. There should be a **minimum** clearance of .12 inch (3,1 mm) between the bottom of the terminal gland and the top of the terminal housing.

See **FINAL ASSEMBLY** and **LUBRICATION**.

FINAL ASSEMBLY

(Figure C-1)

If the discharge flange (25) was removed from the motor housing, replace the discharge flange gasket (24). Apply 'Never-Seez' or equivalent compound on the flange studs (26), and secure the flange with the nuts (27).

If the hoisting bail (23) was removed, install the bail bushing (22) and secure the bail to the motor housing with the hardware (19, 20 and 21).

Connect the discharge hose, and reposition the pump. If rigid piping or long hose is used, reposition the pump then connect the piping.

VACUUM TESTING

To ensure the water-tight integrity of the pump, it is recommended that the motor and seal cavities be vacuum tested any time the seal(s) and/or motor are serviced.

Use a manometer with a range of 30 to 0 to 30 inches of mercury to perform the test. **Do not** use a vacuum gauge. Vacuum gauges are not sensitive enough to detect minor leaks.

It is recommended that a vacuum pump be used to draw the vacuum on the cavities. If a vacuum pump is not available, a compressor/venturi system may be used, see Figure C-7.

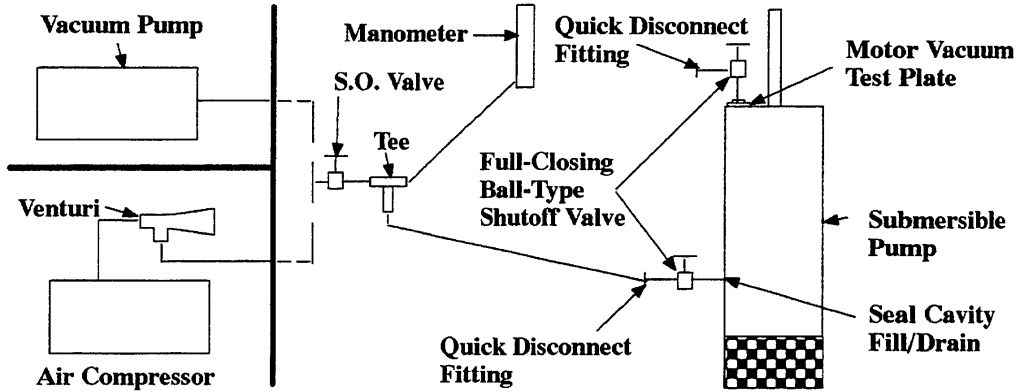

Figure C-7. Vacuum Test System

Seal Cavity Testing

If the water-tight integrity of the motor was not disturbed during disassembly, the seal cavity can be tested without testing the motor.

Drain all of the oil from the seal cavity before performing the test. Oil within the cavity will be drawn into the system, resulting in damage to the vacuum pump or manometer.

See Figure C-7 and connect the vacuum pump or compressor/venturi system directly to the pump at the hole for the seal cavity drain plug (8).

Draw the seal cavity vacuum down to **not more than 10 In. Hg.** and hold for 10 minutes. If no change in vacuum reading is detected, proceed with LUBRICATION.

10 In. Hg. Lower vacuum can cause separation of the seal faces and/or unseating of the upper seal stationary seat, resulting in seal leakage.

Seal And Motor Cavity Testing

Connect the vacuum pump or compressor/venturi system to the pump as shown in Figure C-7.

If the compressor/venturi cannot draw the higher vacuum level shown in Table C-1, draw the motor cavity vacuum down as far as the system will allow, then draw the seal cavity down so the differential between the two cavities is the same as the differential between the vacuum readings shown in the table.



Do not draw the seal cavity vacuum below

To vacuum test the motor cavity, the terminal housing assembly must be replaced with a test plate. Make the test plate as shown in Figure C-8 below, then proceed with vacuum testing.

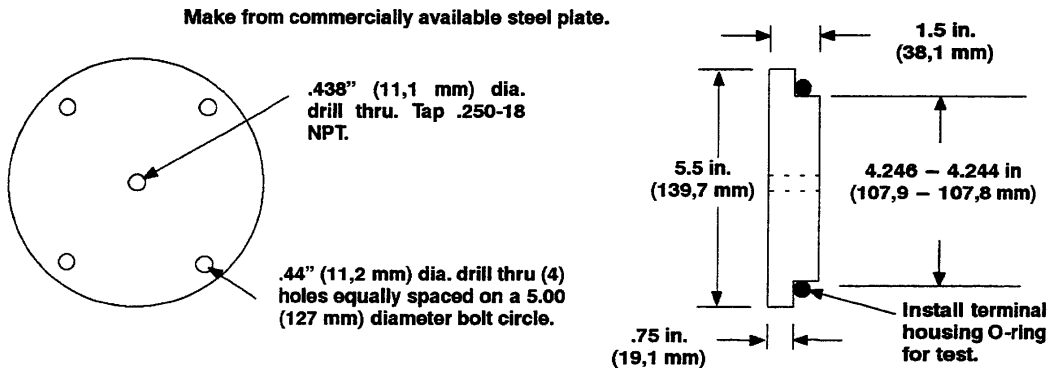

Figure C-8. Motor Vacuum Test Plate

Install full-closing ball-type shutoff valves with quick-disconnect fittings in the pipe plug holes in both the motor and seal cavities. Test the motor cavity for its full duration first, then use the shutoff valve to maintain the motor cavity vacuum while testing the seal cavity. The motor cavity vacuum **must** be higher than the vacuum in the seal cavity to prevent separation of the seal faces or unseating the stationary seal seat between the seal and motor cavities.

Figure C-7 shows a simple schematic for setting up either a vacuum pump or a venturi/compressor test system.

Table C-1 shows the vacuum to be drawn on each cavity, and the duration to maintain each vacuum reading. **Any** change in vacuum reading during the test indicates a leak which **must** be identified and corrected before putting the pump back into service.

Table C-1. Vacuum Test Data

Pump Model	Motor Cavity Vacuum (In. Hg.)	Duration (Minutes)	Seal Cavity Vacuum (In. Hg.)	Duration (Minutes)
SM4G/SM4J	30	2	20	1

LUBRICATION

Seal Cavity

(Figure C-1)

Check the oil level in the seal cavity before initial startup, after the first two weeks of operation, and every month thereafter.

the seal cavity with oil. Reinstall the seal cavity plugs.

When lubricating a dry (overhauled) pump, see Table C-2 for the amount of lubricant and Table C-3 for lubricant specifications.

The grade of lubricant used is critical to the operation of this pump. Use uninhibited transformer oil as specified in Table C-3.

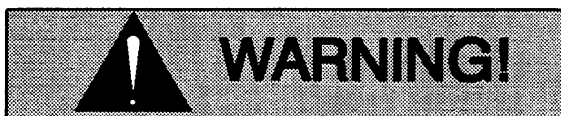

Check the oil level only when the pump is cool. If the oil level plug is removed when the pump is hot, pressure in the seal cavity can cause hot oil to be ejected as the plug is removed.

To check the seal cavity oil, clean any dirt from around pipe plug (5) and remove the plug. Remove the seal cavity drain plug (6), and screw a short 3/8 inch NPT nipple into the hole. Plug the open end of the nipple with your finger. Tip the pump and drain off a small amount of oil into a transparent cup, and stand the pump up again. If the oil level is abnormally low, or the color milky or dark, refer to **Draining Oil From Seal Cavity** in this section for instructions and troubleshooting tips. If the oil is clear, remove the nipple and, with the pump vertical, top off

Table C-2. Oil Quantity

Pump Model	Seal Cavity
SM4G	112 ounces (3,3 liter)
SM4J	144 ounces (4,3 liter)

Motor Bearings

(Figure C-1)

The motor is cooled by the constant flow of the liquid being discharged through internal passages surrounding the motor housing. The rotor shaft bearings are permanently sealed, and no additional lubrication is required.

Table C-3. Pump Oil Specifications

Specifications:	
Type	Premium high viscosity index, anti-wear hydraulic oil
Viscosity @ 100°F (38°C)	110 to 155
Viscosity @ 210°F (99°C)	40 to 50
Dielectric	26,000 (volts-min)
Recommended supplier:	
Gulf Oil Company	Gulf Harmony HVI AW 26
Acceptable alternate suppliers:	
Gulf Oil Company	Gulf Harmony 32 AW
Texas Oil Company	Rando HD 32 or HD AZ 32
Sun Oil Company	Sunvis 816 or 916
BP (Also Boron)	Energol-HLP 32
Shell Oil Company	Tellus 32, Tellus T-23 or T32
ARCO	Duro 32
Exxon (Also Esso)	Nuto H 32
Petro-Canada	Harmony HVI 22

**For U.S. and International Warranty Information,
Please Visit www.grpumps.com/warranty
or call:
U.S.: 419-755-1280
International: +1-419-755-1352**

**For Canadian Warranty Information,
Please Visit www.grcanada.com/warranty
or call:
519-631-2870**