

INSTALLATION, OPERATION, PARTS LIST,
AND MAINTENANCE MANUAL



OM-00660-0B

SEPTEMBER 5, 1979
ISSUE 4



***Basic Self-Priming
Centrifugal Pump
Model 14A20-B***

THE GORMAN-RUPP COMPANY • MANSFIELD, OHIO
GORMAN-RUPP OF CANADA LIMITED • ST. THOMAS, ONTARIO, CANADA

Printed in U.S.A.

Copyright by the Gorman-Rupp Company

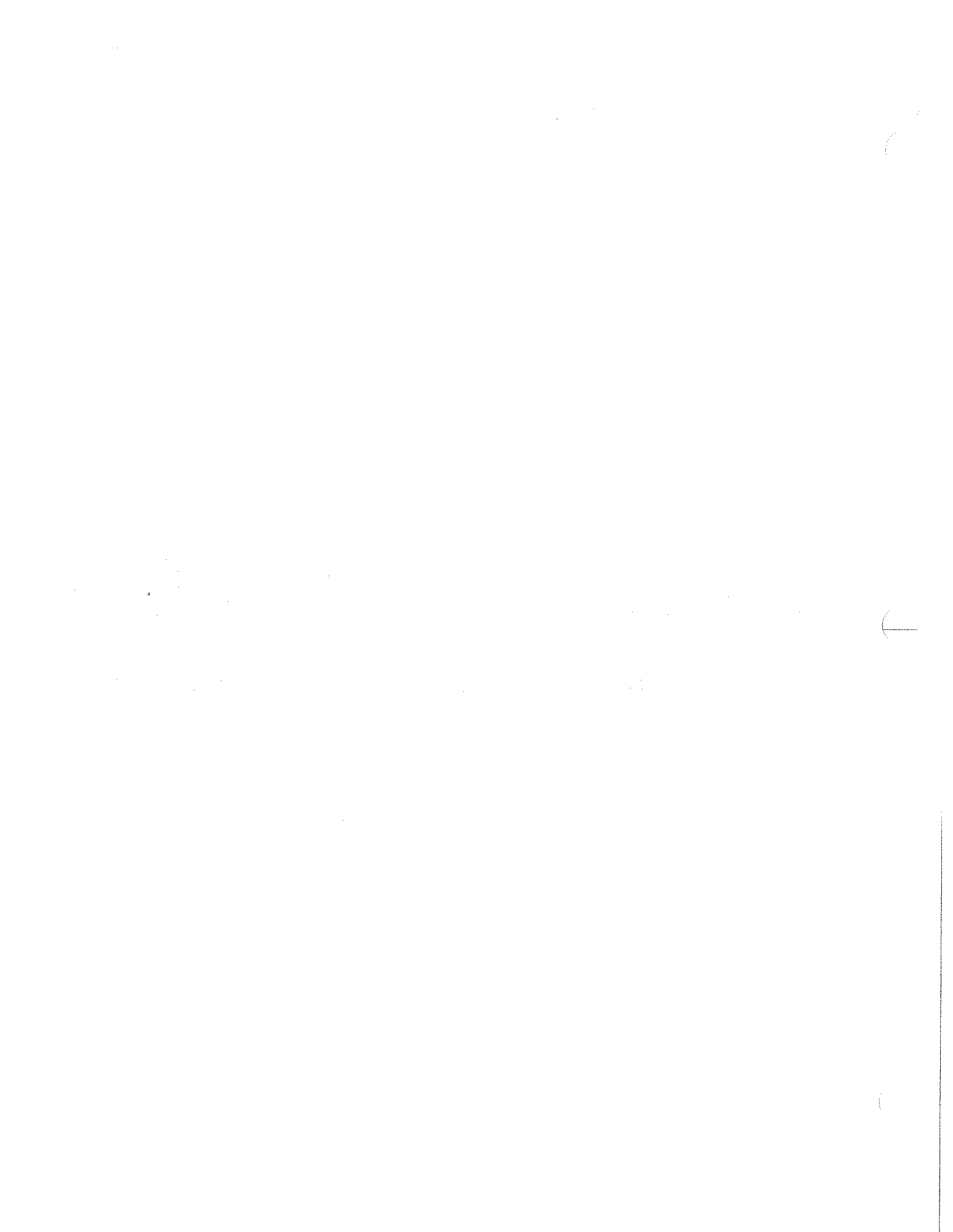

This Installation, Operation, and Maintenance Manual is designed specifically to help you get the best performance and longest life from your Gorman-Rupp pump.

This pump is a 10 Series, semi-open impeller, self-priming centrifugal model designed for pumping liquids with specified entrained solids.

If there are any questions regarding the pump which are not covered in this manual or in other literature accompanying the unit, please contact your Gorman-Rupp distributor, or write:

The Gorman-Rupp Company
P.O. Box 1217
Mansfield, Ohio 44902

For information or technical assistance on the power source, contact the power source manufacturer's local dealer or representative.

The following are used to alert maintenance personnel to procedures which require special attention, to those which could damage equipment, and to those which could be dangerous to personnel:

NOTE

Instructions to aid in installation, operation, or maintenance or which clarify a procedure.

CAUTION

Instructions which must be followed to avoid causing damage to the product or other equipment incidental to the installation. These describe the procedure required and the damage which could result from failure to follow the procedure.

WARNING

Instructions which must be followed to avoid causing injury or death to personnel. These describe the procedure required and the injury which could result from failure to follow the procedure.

TABLE OF CONTENTS

WARNINGS	Section A
INSTALLATION	Section B
OPERATION	Section C
TROUBLESHOOTING	Section D
MAINTENANCE AND REPAIR	Section E
WARRANTY	

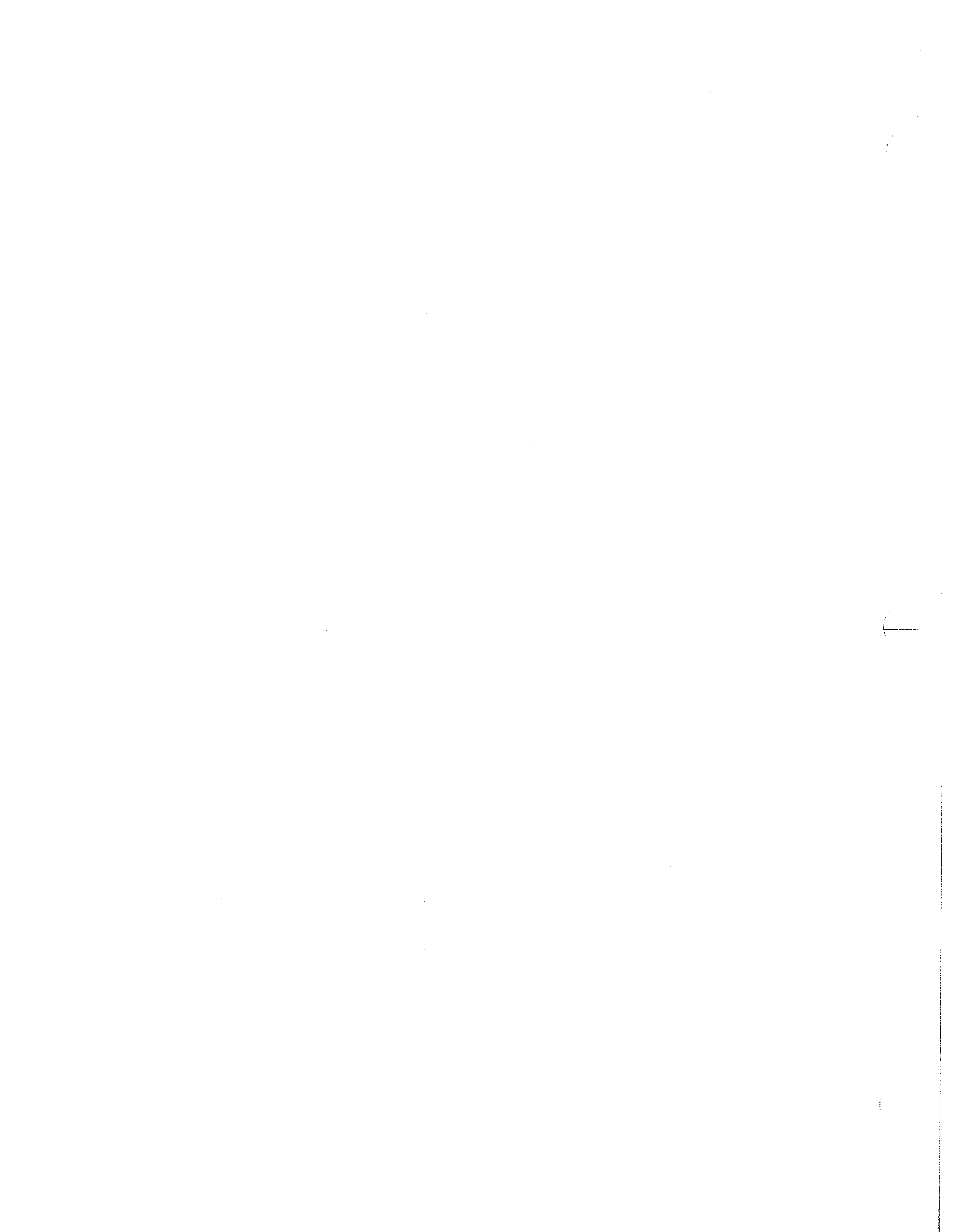

WARNINGS

THESE WARNINGS APPLY TO ALL BASIC PUMPS. GORMAN-RUPP HAS NO CONTROL OVER OR PARTICULAR KNOWLEDGE OF THE POWER SOURCE WHICH WILL BE USED. REFER TO THE MANUAL ACCOMPANYING THE POWER SOURCE BEFORE ATTEMPTING TO START THE POWER SOURCE.

Before attempting to open or service the pump:

1. Familiarize yourself with this manual.
2. Disconnect the power source to ensure that the pump will remain inoperative.
3. Allow the pump to cool if overheated.
4. Vent the pump slowly and cautiously.
5. Close the suction and discharge valves.
6. Check the temperature before opening any covers, plates, or plugs.
7. Drain the pump.

Do not attempt to pump volatile or flammable materials for which this pump has not been designed.

After the pump has been located in its operating position, make certain that the pump has been secured before attempting to operate it.

Do not operate the pump without shields and/or guards in place over drive shafts, belts and/or couplings, or other rotating parts. Exposed rotating parts can catch clothing, fingers, or tools, causing severe injury to personnel.

Do not operate the pump against a closed discharge valve for long periods of time. This could bring the liquid to a boil, build pressure, and cause the pump to rupture or explode.

Overheated pumps can cause severe burns and injury. If overheating of the pump casing occurs:

1. Stop the pump immediately.
2. Allow the pump to cool.
3. Refer to instructions in this manual before restarting the pump.

Do not remove plates, covers, gauges, pipe plugs, or fittings from an overheated pump. Vapor pressure within the pump can cause parts being disengaged to be ejected with great force. Allow the pump to cool before servicing.

INSTALLATION

Seldom are two pump installations identical. The information presented in this section is a summary of the recommended installation practices related to inspection, pump positioning, hardware, suction and discharge piping, and sumps. For further assistance, contact your Gorman-Rupp distributor or the Gorman-Rupp Company.

PREINSTALLATION INSPECTION

The pump assembly was inspected and tested before it was shipped from the factory. Before installation, inspect the pump for damage which may have occurred during shipment. Check as follows:

- a. Inspect the pump assembly for cracks, dents, damaged threads, and other obvious damage.
- b. Check for and tighten loose bolts, nuts, cap screws, and other attaching hardware. Since gaskets tend to shrink after drying, check for and tighten loose nuts and cap screws securing mating surfaces.
- c. Carefully read all tags, decals, and markings on the pump assembly, and perform all duties indicated. Note the direction of rotation indicated on the pump. Check that the pump shaft rotates in the required direction.

CAUTION

Only operate this pump in the direction indicated by the arrow on the pump body and on the accompanying decal. Otherwise, the impeller could become loosened from the shaft and seriously damage the pump.

- d. Check all lubricant levels and lubricate as necessary. Refer to the MAINTENANCE AND REPAIR section of this manual.

POSITIONING THE PUMP

Mounting

Locate the pump in an accessible place as close as practical to the liquid to be pumped. Level mounting is essential for proper operation. The pump may have to be supported to provide for level operation or to eliminate vibration.

Lifting

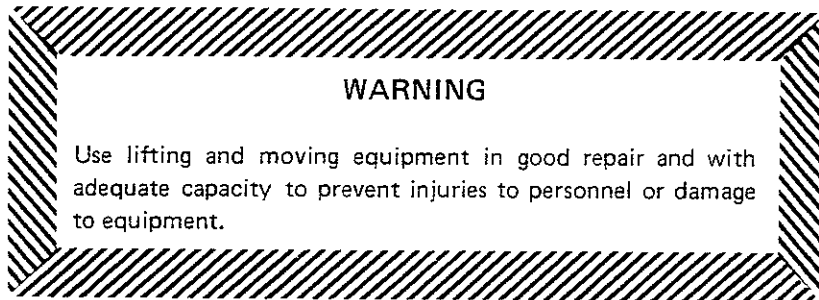

Make sure that hoists and other lifting equipment are of sufficient capacity to safely handle the pump assembly. Attach the lifting mechanism to the bail, eye bolt, or other specific lifting device provided on the pump. If no specific lifting device is provided and chains or cables must be used, make certain that they are positioned so that they will not damage the pump, and so that the load will be balanced.

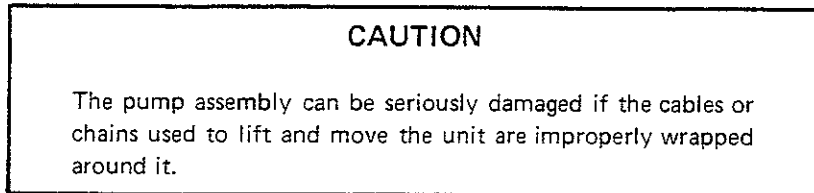

SUCTION AND DISCHARGE PIPING

Materials

Either pipe or hose may be used for suction and discharge lines, but hose used in suction lines must be the rigid-wall, reinforced type to prevent collapse under suction. Using pipe couplings in suction lines is not recommended.

Line Configuration

Keep suction and discharge lines as straight as possible to minimize friction losses. Make minimum use of elbows and fittings, which substantially increase friction loss. If elbows are necessary, use the long-radius type to minimize friction loss.

Connections to Pump

Never pull a pipe line into place by tightening the flange bolts. The connecting flange must be aligned exactly with the pump port. Lines near the pump must be independently supported to avoid strain on the pump which could cause serious vibration, decreased bearing life, and increased shaft and seal wear. Hose-type lines should have supports strong enough to secure the line when it is filled with liquid and under pressure.

Gauges

Most pumps are drilled and tapped for installing discharge pressure and vacuum suction gauges. If these gauges are desired for pumps that are not tapped, drill and tap the suction and discharge lines close to the pump before installing the lines.

SUCTION LINES

To avoid air pockets which could affect pump priming, the suction line must be as short and direct as possible. When operation involves a suction lift, the line must always slope upward to the pump from the source of the liquid being pumped; if the line slopes down to the pump at any point along the suction run, air pockets will be created.

Fittings

Suction lines should be the same size as the pump inlet. If reducers are used in suction lines, they should be the eccentric type, and should be installed with the flat part of the reducers uppermost to avoid creating air pockets. Valves are not normally used in suction lines, but if a valve is used, install it with the stem down or to either side to avoid air pockets.

Strainers

Install a strainer at the end of the suction line to avoid possible clogging or damage to the pump. The total area of the openings in the strainer should be at least three or four times the cross section of the suction line, but no opening should be larger than the solids handling capability of the pump. Clean the strainer regularly during operation.

Sealing

All connections in the suction line should be sealed with pipe dope to ensure an airtight seal. Even a slight leak will affect priming, head, and capacity, especially when operating with a high suction lift. After installation, inspect the suction line carefully for potential leaks.

DISCHARGE LINES

Throttling Valves

If a throttling valve is desired, install it in the discharge line. Use a valve as large as the largest pipe in the line to minimize friction losses. Never install a throttling valve in the suction line.

Check Valves

A check valve in the discharge line is normally recommended, but is not necessary in low discharge head applications.

With high discharge heads, install a throttling valve and a check valve in the discharge line to protect the pump from excessive shock pressure and reverse rotation when it is stopped.

Bypass Lines

If it is necessary to permit the escape of air to atmosphere during initial priming or in the repriming cycle, install a bypass line between the pump and the discharge check valve. The bypass line should be sized so that it does not affect pump discharge capacity.

Either a Gorman-Rupp automatic air release valve—which will automatically open to allow the pump to prime, and automatically close when priming is accomplished—or a hand-operated shutoff valve should be installed in the bypass line.

NOTE

The bypass line may clog frequently, particularly if the valve remains closed. If this condition occurs, either use a larger bypass line or leave the shutoff valve open during the pumping operation.

Do not terminate the discharge line at a level lower than that of the liquid being pumped unless a siphon breaker is used in the line. Otherwise, a siphoning action could result, causing damage to the pump.

SUCTION LINE POSITIONING

The depth of submergence of the suction line is critical to efficient pump operation. Figure 1 shows recommended minimum submergence vs. velocity.

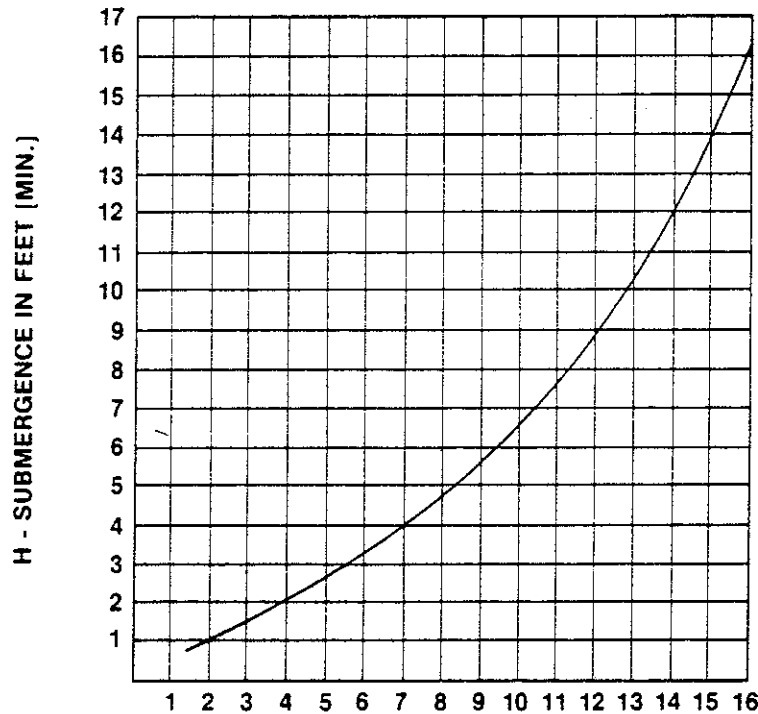

$$\text{VELOCITY IN FEET PER SEC.} = \frac{\text{QUAN. [G.P.M.] x .321}}{\text{AREA}} \text{ OR } \frac{\text{G.P.M. x .4085}}{D^2}$$

Figure 1. Recommended Minimum Suction Line Submergence Vs. Velocity

Single Suction Lines

Install a single suction line a distance from the wall of the sump equal to one and one-half the size of the suction line. Liquid flow into a sump should never enter near the pump suction inlet because inflow will carry air down into the sump, and air entering the suction line will reduce pump efficiency.

If it is necessary to position an inflow pipe close to the suction inlet, install a baffle a distance from the suction inlet equal to one and one-half the size of the suction line (see figure 2). This baffle will allow entrained air to escape before the liquid is drawn into the suction line.

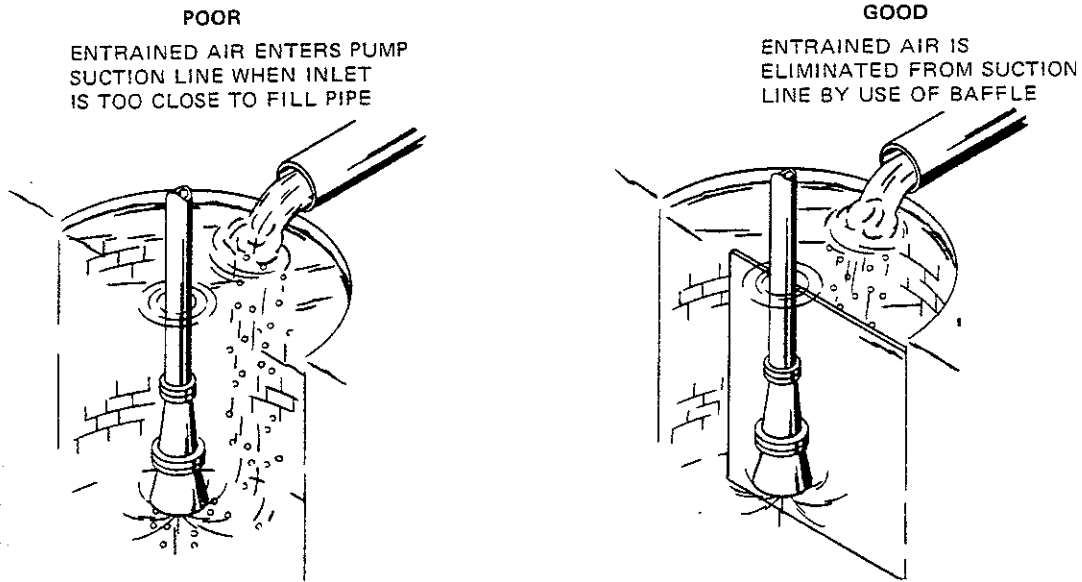

Figure 2. Eliminating Entrained Air Caused by a Fill Pipe

Multiple Suction Lines

When two suction lines are installed in one sump, separate the inlets by at least three times the diameter of the suction pipe. If the suction inlets are too close together, the flow paths may interact, reducing the efficiency of one or both pumps (see figure 3).

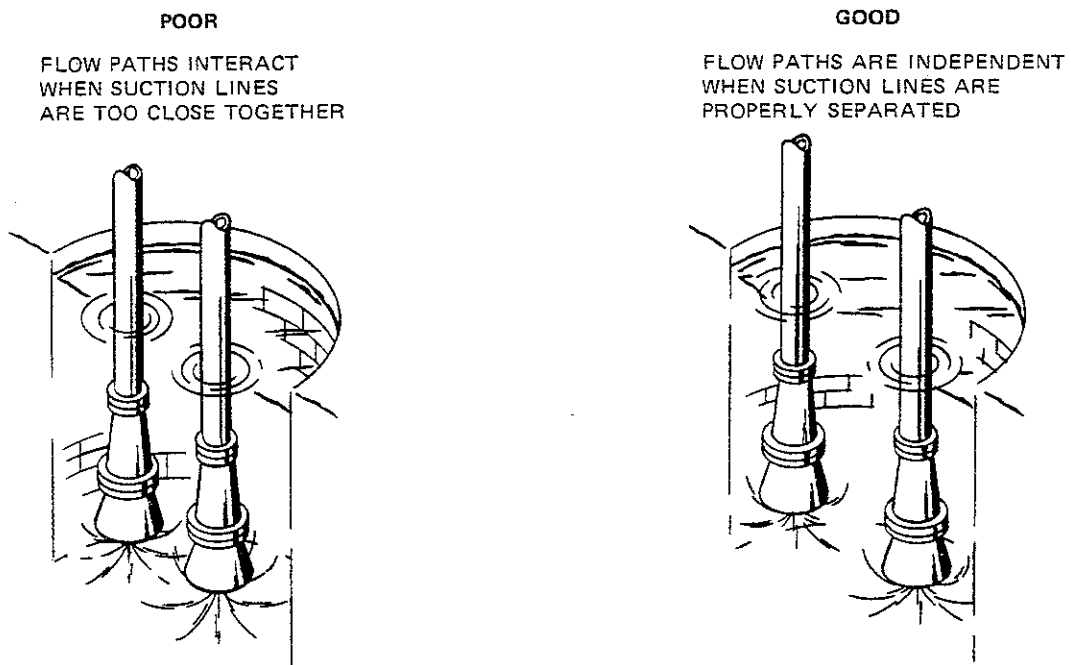

Figure 3. Using Two Pumps in the Same Sump

ALIGNMENT

The alignment of the pump and its power source is critical for trouble-free mechanical operation. In either a flexible coupling or V-belt driven system, the driver and pump must be mounted so that their shafts are aligned with and parallel to each other.

NOTE

When mounted at the Gorman-Rupp factory, driver and pump are aligned before shipment. Misalignment can occur in transit and handling, however, and pumps should be checked, and realigned if necessary, before being put into operation.

Before checking alignment, tighten the foundation bolts. The pump casing feet and/or pedestal feet, and the driver mounting bolts should also be tightly secured.

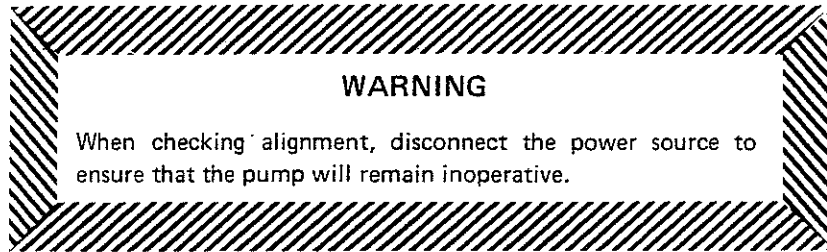

Aligning Coupling Driven Pumps

In coupling applications, the axis of the drive unit must be aligned to the axis of the pump shaft in both the horizontal and vertical planes. Most couplings require a specific gap or clearance between the driving and the driven shafts. Refer to the coupling manufacturer's service literature for information.

To check non-spider type couplings, use a feeler gauge or a taper gauge between the coupling halves every 90 degrees. The coupling is in alignment when the hubs are the same distance apart at all points (see figure 5A).

To check spider insert type couplings, use calipers to measure the dimensions on the circumference of the outer ends of the coupling hub every 90 degrees. The coupling is in alignment when the hub ends are the same distance apart at all points (see figure 5B).



Figure 5A. Aligning Non-Spider Type Couplings

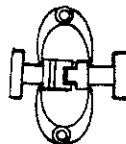

Figure 5B. Aligning Spider-Type Couplings

To check parallel adjustment, lay a straightedge across both coupling rims at the top, bottom, and side. The coupling is in horizontal parallel alignment when the straightedge rests evenly on both halves of the coupling. Use a feeler gauge between the coupling and the straightedge to measure the amount of misalignment.

Coupling and alignment adjustments may be made by loosening the hold-down bolts and shifting the driver and pump, or by shimming as required.

CAUTION

Adjusting the alignment in one direction may alter the alignment in another direction. Check each procedure after altering alignment.

Aligning V-Belt Driven Pumps

If V-belts and pulleys connect the drive unit to the pump, the unit and the pump must be parallel and the pulleys properly aligned. Use a straightedge along the sides of the pulleys to ensure alignment. For drive systems that employ two or more belts, make sure that the belts are a matched set; unmatched sets will result in accelerated belt wear (see figure 5C).

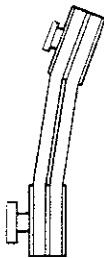

MISALIGNED: SHAFTS NOT PARALLEL



MISALIGNED: SHEAVES NOT IN LINE

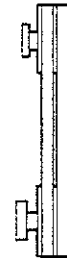

ALIGNED: SHAFTS PARALLEL AND SHEAVES IN LINE

Figure 5C. Alignment of V-Belt Driven Pumps

Tighten the belts in accordance with the belt manufacturer's instructions. The belts will slip if they are too loose; there will be excessive power loss and possible bearing failure if they are too tight. Select pulleys that will provide the proper speed ratio. Overspeeding the pump may damage both pump and driver.

Drive Shaft Guards

Driver and shaft assemblies, couplings, and belts and sheaves mounted at the Gorman-Rupp factory are supplied with a guard for protection of personnel. Do not operate the pump without a guard.

WARNING

Do not operate the pump without a guard over the rotating parts. Exposed rotating parts can catch clothing, fingers, or tools, causing severe injury to personnel.

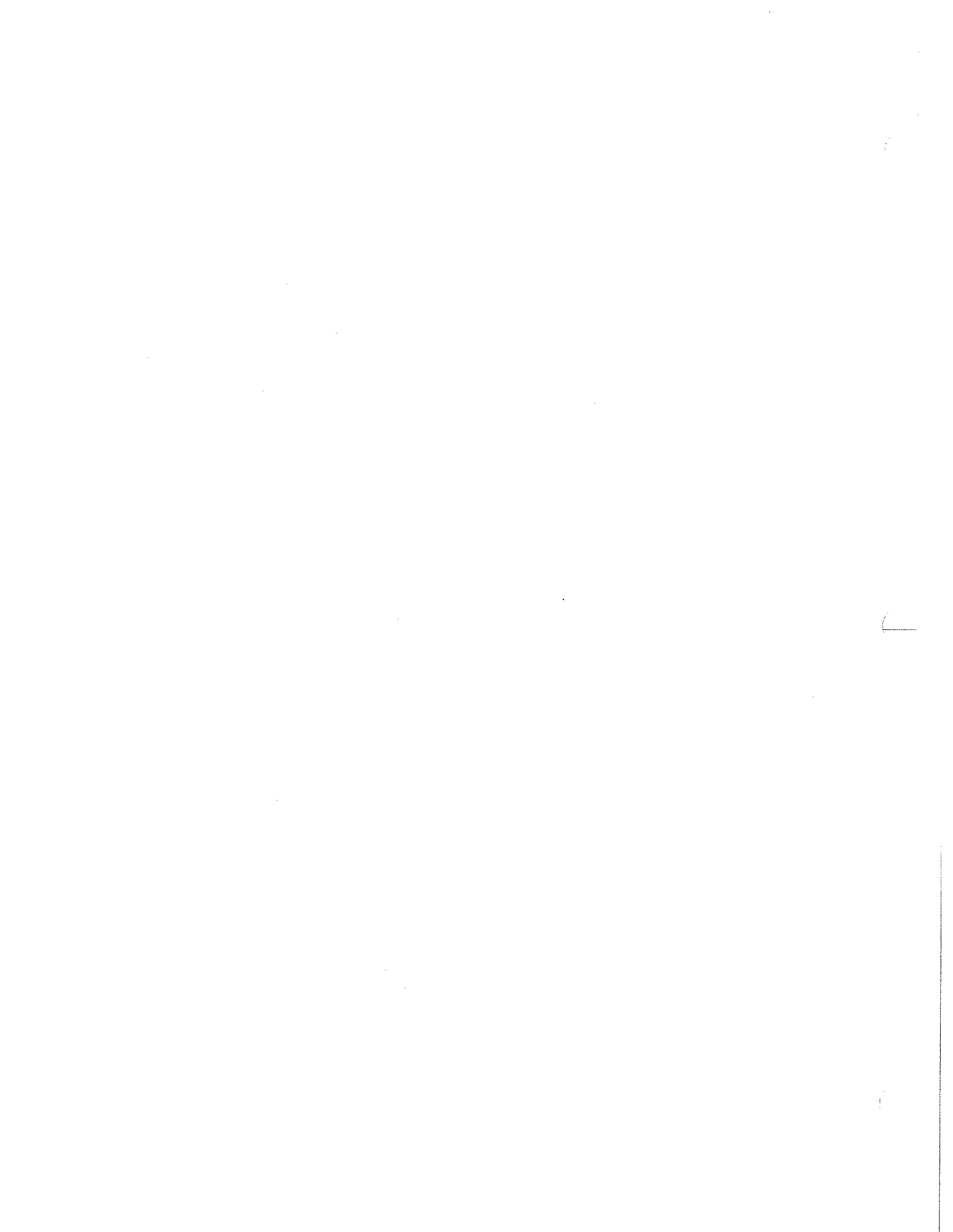

OPERATION

WARNING

Do not attempt to pump volatile or corrosive materials for which this pump has not been designed.

PRIMING

Install the pump and piping as described in **INSTALLATION**. Make sure that the piping connections are tight, and that the pump is securely mounted. Check that the pump is properly lubricated (see **LUBRICATION** in **MAINTENANCE AND REPAIR**).

This pump is self priming, but the pump volute casing must first be filled with liquid if:

1. The pump is being put into service for the first time.
2. The pump has not been used for a considerable length of time.
3. The liquid in the volute casing has evaporated.

Once the volute casing has been filled, the pump will prime and reprime as necessary.

CAUTION

Never operate a self-priming pump unless the volute is filled with liquid. The pump will not prime when dry. Extended operation of a dry pump will destroy the seal assembly.

To fill the pump, remove the volute fill cover or fill plug at the top of the casing and add clean liquid until the pump is filled. Replace the fill cover or fill plug before operating the pump.

STARTING

Consult the operating manual furnished with the power source.

Rotation

The correct direction of pump rotation is indicated by an arrow on the pump body and on the accompanying decal. If the pump is operated in the wrong direction, the impeller could become loosened and the pump damaged.

CAUTION

Only operate this pump in the direction indicated by the arrow on the pump body and on the accompanying decal. Otherwise, the impeller could become loosened from the shaft and seriously damage the pump.

When checking the rotation of a pump driven by a three-phase electric motor, start the pump for a moment to see if the rotation is correct. If the shaft, coupling, or V-belt is not visible, rotation can usually be determined by observing the motor cooling fan. If the rotation is incorrect, have qualified personnel interchange any two of the three-phase wires to change direction.

Lines With a Bypass

Either a Gorman-Rupp automatic air release valve or a hand operated shutoff valve may be installed in a bypass line.

If a Gorman-Rupp automatic air release valve has been installed, close the throttling valve in the discharge line. The Gorman-Rupp valve will automatically open to allow the pump to prime, and automatically close when priming has been accomplished. After the pump has been primed, and liquid is flowing steadily from the bypass line, open the discharge throttling valve.

If a hand operated shutoff valve has been installed, close the throttling valve in the discharge line, and open the bypass shutoff valve so that the pump will not have to prime against the weight of the liquid in the discharge line. When the pump has been primed, and liquid is flowing steadily from the bypass line, close the bypass shutoff valve and open the discharge throttling valve.

Lines Without a Bypass

Open all valves in the discharge line and start the power source. Priming is indicated by a positive reading on the discharge pressure gauge or by quieter operation. The pump may not prime immediately because the suction line must first fill with liquid. If the pump fails to prime within five minutes, stop it and check the suction line for leaks.

After the pump has been primed, partially close the discharge line throttling valve in order to fill the line slowly and guard against excessive shock pressure which could damage pipe ends, gaskets, sprinkler heads, and any other fixtures connected to the line. When the discharge line is completely filled, adjust the throttling valve to the required discharge flow rate.

Leakage

No leakage should be visible at pump mating surfaces, or at pump connections or fittings. Keep all line connections and fittings tight to maintain maximum pump efficiency.

Overheating

Overheating can occur if the valves in the suction or discharge lines are closed. Operating against closed valves could bring the liquid to a boil, build pressure, and cause the pump to rupture or explode. If overheating occurs, stop the pump and allow it to cool before servicing it. Refill the volute casing with cool liquid.

**WARNING**

Do not remove plates, covers, gauges, pipe plugs, or fittings from an overheated pump. Vapor pressure within the pump can cause parts being disengaged to be ejected with great force. Allow the pump to cool before servicing.

Strainer Check

Check the suction strainer regularly during pump operation, or if the pump flow rate begins to drop, and clean it as necessary. Be especially alert for unusual noises when pumping liquids containing solids.

Pump Vacuum Check

Install a vacuum gauge in the system, using pipe dope on the threads.

The pump should pull a vacuum of 20 inches or more of mercury at operating speed with the suction line blocked. If it does not, check for air leaks in the seal or gaskets.

With the pump primed and at operating speed, and the suction line open, read the vacuum gauge. Shut off the pump, keep the vacuum line open, and read the gauge again to see if the vacuum remains at the maximum developed by the pump. If the vacuum falls off rapidly, an air leak exists. If the liquid level at the source of supply remains at a constant level, check to make certain that the air leak is not from the vacuum gauge connection.

STOPPING

After stopping the pump, disconnect the power source to ensure that the pump will remain inoperative.

In below freezing conditions, drain the pump to prevent damage from freezing. Also, clean out any solids by flushing with a hose. Operate the pump for approximately one minute; this will remove any remaining liquid that could freeze the pump rotating parts.

If the pump will be idle for more than a few hours, or if it has been pumping liquids containing a large amount of solids, drain the pump, and flush it thoroughly with clean water. To prevent large solids from clogging the drain port and preventing the pump from completely draining, operate the pump during the draining process. Clean out any remaining solids by flushing with a hose.

BEARING TEMPERATURE CHECK

Bearings normally run at higher than ambient temperatures because of heat generated by friction. Temperatures up to 160°F are considered normal for pedestal bearings, and they can operate safely to at least 180°F.

Checking bearing temperatures by hand is inaccurate. They can be measured accurately by placing a contact-type thermometer against the housing. Record this temperature for future reference.

A sudden increase in bearing temperatures is a warning that the bearings are at the point of failing to operate properly. Make certain that the bearing lubricant is of the proper viscosity and at the correct level (see LUBRICATION in MAINTENANCE AND REPAIR). Bearing overheating can also be caused by shaft misalignment and/or excessive vibration.

When pumps are first started, the bearings may seem to run at temperatures above normal. Dynamic operation will bring the temperatures down to normal levels.

TROUBLESHOOTING

WARNING

Before attempting to open or service the pump:

1. Consult pump service manual.
2. Disconnect the power source to ensure that the pump will remain inoperative.
3. Allow pump to cool if overheated.
4. Close suction and discharge valves.
5. Drain pump.

Trouble	Possible Cause	Probable Remedy
PUMP FAILS TO PRIME	<p>Air leak in suction line.</p> <p>Lining of suction hose collapsed.</p> <p>Suction check valve clogged or binding.</p> <p>Leaking or worn seal or pump gasket.</p> <p>Suction lift or discharge head too high.</p> <p>Suction strainer clogged.</p>	<p>Correct leak.</p> <p>Replace suction hose.</p> <p>Clean valve.</p> <p>Check pump vacuum. Replace leaking or worn seal or gasket.</p> <p>Check piping installation and install bypass line if needed. See INSTALLATION.</p> <p>Clean suction strainer.</p>
PUMP STOPS OR FAILS TO DELIVER RATED FLOW OR PRESSURE	<p>Air leak in suction line.</p> <p>Suction intake not submerged at proper level or sump too small.</p> <p>Lining of suction hose collapsed.</p> <p>Impeller or other wearing parts worn or damaged.</p> <p>Impeller clogged.</p> <p>Pump speed too slow.</p> <p>Discharge head too high.</p> <p>Suction lift too high.</p>	<p>Correct leak.</p> <p>Check installation and correct as needed. Check submergence chart (Section B, page 4).</p> <p>Replace suction hose.</p> <p>Check impeller clearance. Replace worn parts as needed.</p> <p>Free impeller of debris.</p> <p>Check driver output; check belts or couplings for slippage.</p> <p>Install bypass line.</p> <p>Reduce suction lift.</p>

Trouble	Possible Cause	Probable Remedy
PUMP STOPS OR FAILS TO DELIVER RATED FLOW OR PRESSURE (cont)	<p>Leaking or worn seal or pump gaskets.</p> <p>Suction strainer clogged.</p>	<p>Check pump vacuum. Replace leaking or worn seal or pump gaskets.</p> <p>Clean suction strainer.</p>
PUMP REQUIRES TOO MUCH POWER	<p>Pump speed too high.</p> <p>Discharge head too low.</p> <p>Liquid solution too thick.</p>	<p>Check driver output; check that sheaves or couplings are correctly sized.</p> <p>Adjust discharge valve.</p> <p>Dilute if possible.</p>
PUMP CLOGS FREQUENTLY	<p>Discharge flow too slow.</p> <p>Suction check valve clogged or binding.</p>	<p>Open discharge valve fully to increase flow rate, and run engine at maximum governed speed.</p> <p>Free valve, and clean or replace it.</p>
EXCESSIVE NOISE	<p>Cavitation in pump.</p> <p>Pumping entrained air.</p> <p>Pump or drive not securely mounted.</p> <p>Impeller clogged or damaged.</p>	<p>Reduce suction lift and/or friction losses in suction line.</p> <p>Locate and eliminate source of air bubble.</p> <p>Secure mounting hardware.</p> <p>Clean out debris; replace damaged parts.</p>
BEARINGS RUN TOO HOT	<p>Bearing temperature is high, but within limits.</p> <p>Low or incorrect lubricant.</p> <p>Suction and discharge lines not properly supported.</p> <p>Drive misaligned.</p>	<p>Check bearing temperature.</p> <p>Check for proper type and level of lubricant.</p> <p>Check piping installation for proper support.</p> <p>Align drive properly.</p>

Basic Self-Priming Centrifugal Pump Model 14A20-B

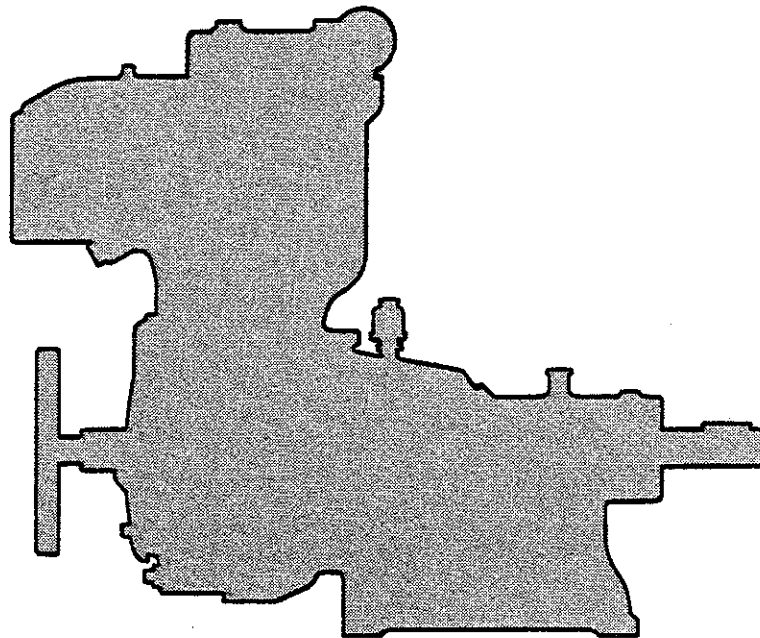

The only moving parts of this pump are the impeller, seal rotating elements, and the shaft. The wear plate, impeller, and seal, which receive the most wear, are easily accessible and can be replaced by removing the cover without disturbing the volute casing and piping. Maintenance and replacement of these three parts will maintain the peak operating efficiency of the pump.

SECTIONAL DRAWING

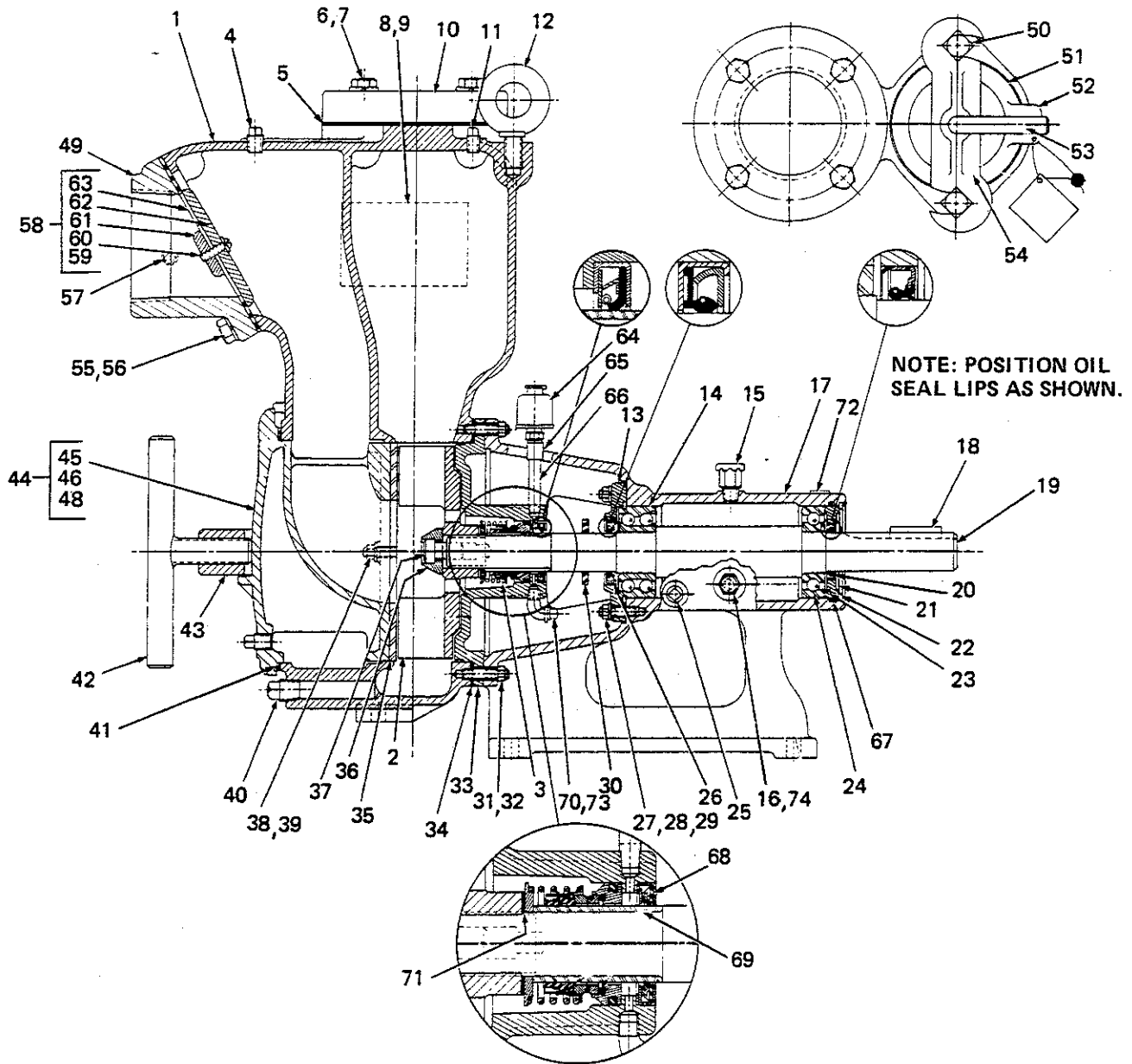

Figure 1. Pump Model 14A20-B

PARTS LIST

ITEM NO.	MODEL 14A20-B PART NAME	PART NUMBER	MATL CODE	ITEM NO.	MODEL 14A20-B PART NAME	PART NUMBER	MATL CODE
1	VOLUTE CASING	2526	10010	39	LOCKWASHER	J-06	15991
2	★ IMPELLER	1692-AS	11000	40	VOLUTE DRAIN PLUG	P-08	11990
3	★ SEAL ASSEMBLY	12446		41	★ COVER GASKET	2527-G	19090
4	ACCESSORY PLUG	P-06	11990	42	COVER CLAMP SCREW	2536	24000
5	★ DISCHARGE FLANGE GASKET	1674-G	18000	43	COVER CLAMP BAR	2528	11000
6	CAP SCREW	B-1008	15991	44	COVER ASSEMBLY	42111-926	
7	LOCKWASHER	J-10	15991	45	★ COVER	2527	10010
8	NAMEPLATE	2613-D	13990	46	WARNING DECAL	2613-EV	13990
9	DRIVE SCREW	BM-4-03	15990	47	DOES NOT APPLY		
10	DISCHARGE FLANGE	271	10010	48	COVER DRAIN PLUG	P-06	11990
11	PIPE PLUG	P-04	11990	49	SUCTION FLANGE	1736	10010
12	EYE BOLT	AR-1003½	15050	50	MACHINE BOLT	A-1014	15991
13	★ BEARING CAP	6691-A	10010	51	★ FILL COVER GASKET	50-G	19090
14	★ BALL BEARING	S-1040		52	FILL COVER ASSY	48271-010	
15	★ PEDESTAL AIR VENT	S-1703		53	FILL COVER CLAMP SCREW	136	15000
16	PIPE PLUG	P-06	11990	54	FILL COVER CLAMP BAR	40	11000
17	PEDESTAL	3064-C	10010	55	HEX HD CAP SCREW	B-1007	15991
18	★ SHAFT KEY	N-0608	15990	56	LOCKWASHER	J-10	15991
19	★ IMPELLER SHAFT	3065-E	15010	57	PIPE PLUG	P-04	11990
20	★ OIL SEAL	25258-411		58	FLAP VALVE ASSY	9915	
21	★ BEARING RETAINING RING	S-271		59	MACHINE SCREW	X-0404	17000
22	★ BEARING SHIM SET	8543	15990	60	LOCKWASHER	J-04	17090
23	★ BEARING RETAINER	38322-516		61	★ VALVE WEIGHT	19	10010
24	★ BALL BEARING	S-1080		62	★ VALVE WEIGHT	2936	10010
25	PEDESTAL DRAIN PLUG	P-06	11990	63	★ VALVE GASKET	131-D	19070
26	★ OIL SEAL	S-1452		64	★ SEAL BOTTLE OILER	S-1933	
27	STUD	C-0606	15991	65	PIPE COUPLING	AE-02	11990
28	LOCKWASHER	J-06	15991	66	PIPE NIPPLE	T-0208	15070
29	HEX NUT	D-06	15991	67	★ O-RING	S-2085	
30	★ SLINGER RING	2352	19120	68	★ OIL SEAL	S-506	
31	STUD	C-0608	15991	69	★ SHAFT SLEEVE	3428-A	17030
32	HEX NUT	D-06	15991	70	SEAL DRAIN PLUG	P-02	11990
33	★ SEAL PLATE	38272-346		71	★ IMPELLER SHIM SET	37-J	17090
34	★ VOLUTE GASKET SET	2474-G	18000	72	ROTATION DECAL	2613-CU	00000
35	★ WEAR PLATE	2605	15990	73	SEAL DRAIN ELBOW	RS-02	11990
36	★ IMPELLER WASHER	10278	15030	74	★ PEDESTAL OIL LEVEL SIGHT GAUGE	26714-011	
37	★ IMPELLER CAP SCREW	DM-1004-S	15991		NOT SHOWN:		
38	HEX NUT	D-06	15991		STRAINER	2690	24000

★ Indicates parts recommended for stock

Note: This parts list applies to pumps from serial no. 662270N.

CANADIAN SERIAL NO. AND UP

PUMP AND SEAL DISASSEMBLY AND REASSEMBLY

This pump requires little service due to its rugged, minimum-maintenance design. If it becomes necessary to inspect and/or replace the wearing parts, however, follow these instructions, which are keyed to the sectional view (see figure 1) and the accompanying parts list.

Pump Disassembly

Disconnect the power source, and close all connecting valves. Remove the volute drain plug (40) to drain the pump. Loosen the cover clamp screw (42) and release the cover clamp bar (43) to remove the cover (45) for access to the wear plate (35), impeller (2), and seal assembly (3). After removing the cover, inspect the wear plate, and replace it if scored or worn.

To loosen the impeller, remove the retaining socket head cap screw (37) and the impeller washer (36). Inspect the impeller, and replace it if cracked or badly worn.

Remove the impeller adjusting shims (71). For ease of reassembly, tag and tie the shims, or measure and record their thickness.

Seal Disassembly

Before removing the seal assembly, remove the seal drain plug (70) to drain the seal cavity. Clean and replace the seal drain plug.

Carefully remove the seal spring seat, the rotating and stationary seal elements, and the shaft sleeve (69), using a stiff wire with a hooked end if necessary.

Clean the seal cavity and impeller shaft with a soft cloth soaked in cleaning solvent.

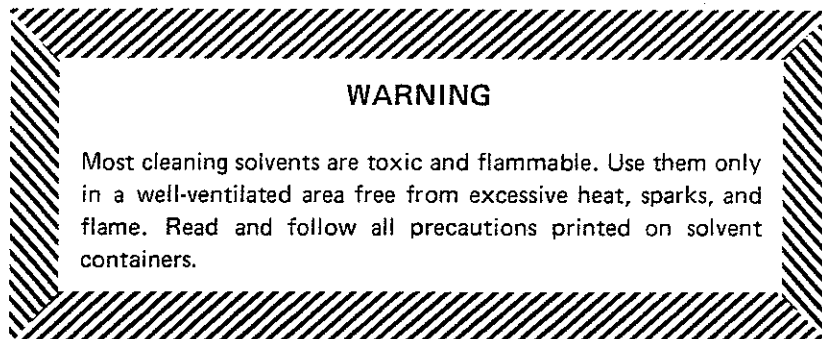

Seal Reassembly

The seal is not normally reused because of the high polish on its lapped face, but if it is necessary to reuse the old seal, wash all metallic parts in cleaning solvent and dry thoroughly.

Inspect the seal components for wear, scoring, grooves, and other damage that might cause leakage. If any components are worn, replace the complete seal; never mix old and new seal parts. Clean and polish the shaft sleeve, or replace it if there are nicks or cuts on the end.

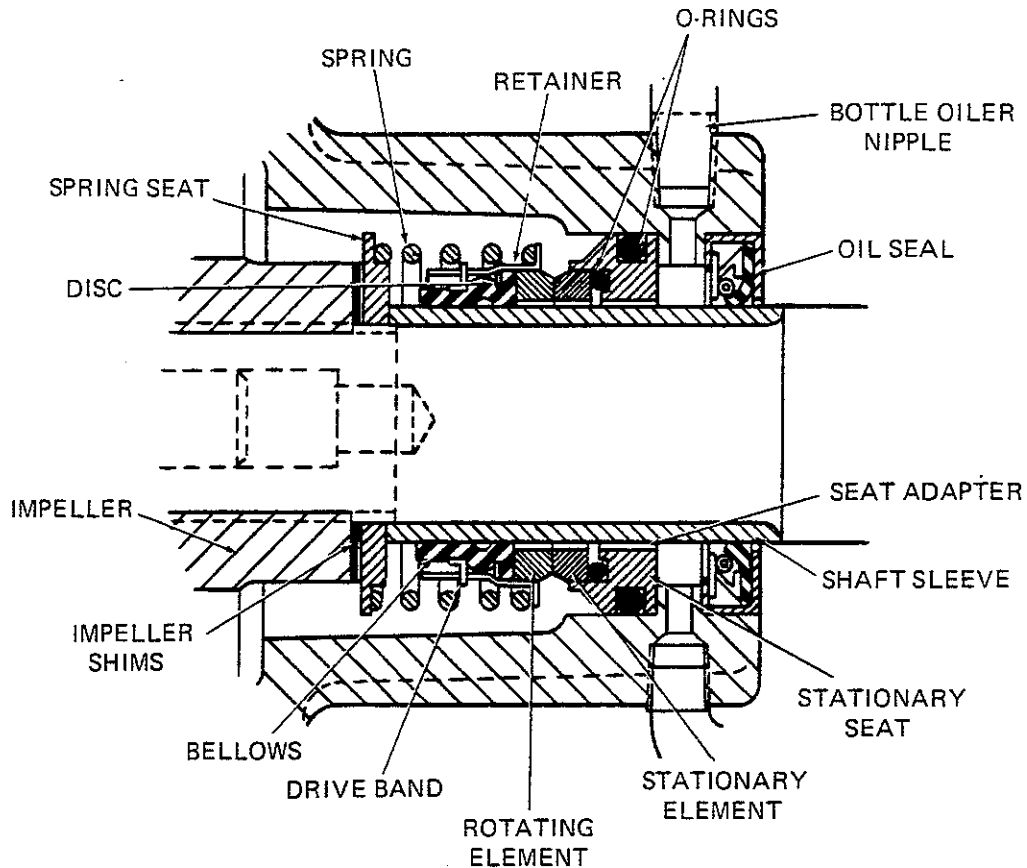

Figure 2. 12446 Seal Assembly

CAUTION

This seal is not designed for operation at temperatures above 160°F. Do not use at higher operating temperatures.

Reinstall the shaft sleeve, and install the replacement seal as a complete unit.

Apply a thin film of retaining compound P/N 18771-102 to side of O-ring and bellows adjacent to seal ring, and place a drop of light lubricating oil on the lapped faces. Assemble the seal as shown in figure 2.

Before starting the pump, fill the bottle oiler (64) with SAE No. 30 non-detergent motor oil.

Pump Reassembly

A clearance of .008 to .015 inch between the impeller and the wear plate, and of .020 to .040 inch between the impeller and the seal plate, is necessary for maximum pump efficiency. These clearances can be reached by adjusting the impeller shims.

If the shaft sleeve, seal assembly, adjusting shims, impeller, or wear plate was not replaced, this clearance should be correct after reassembling the impeller shims, impeller, and cover. Apply "Never-Seez", or equivalent, to the threads of the impeller retaining nut, and torque to 90 ft-lbs. Replace the cover gasket (41) when reinstalling the cover.



If the shaft sleeve, seal assembly, adjusting shims, impeller, or wear plate was replaced, the clearance between the impeller and the wear plate must be checked after reassembling the pump.

Rotate the shaft by hand, and add or subtract impeller shims until the shaft binds. After the shaft binds, remove .010 inch of impeller shims, then reassemble the pump. The clearance should now be correct.

Before starting the pump, clean and reinstall the volute drain plug and fill the volute with liquid.

LUBRICATION

Bearings

Oil-lubricated bearings should be drained and filled yearly under normal operating conditions, but the oil level should be checked regularly. Do not add oil sooner than required; over-oiling will cause excessive preloading and overheating which will shorten bearing life.

When lubrication is required, remove the pedestal air vent (15) and fill the bearing housing with a good grade of non-detergent SAE No. 30 motor oil to the midpoint of the oil level sight gauge (74). Do not overfill the housing. Clean and reinstall the pedestal air vent.



WARRANTY

Pumping units manufactured by The Gorman-Rupp Company, Mansfield, Ohio are guaranteed to be free from defects in material and workmanship for one year from date of shipment from factory in Mansfield, Ohio. The obligation under this Warranty, statutory or otherwise, is limited to replacement or repair at Mansfield, Ohio factory or at a point designated by Gorman-Rupp, of such part as shall appear to us, upon inspection at such point, to have been defective in material or workmanship.

This Warranty does not obligate The Gorman-Rupp Company to bear the cost of labor or transportation charges in connection with replacement or repair of defective parts; nor shall it apply to a pump upon which repairs or alterations have been made unless authorized by Gorman-Rupp.

No warranty is made in respect to engines, motors, or trade accessories, such being subject to warranties of their respective manufacturers.

In Submersible Pumps, pump and motor are integral and Submersibles are warranted as a unit. Since motor is subject to an important degree upon quality and performance of electrical controls, unit warranty is valid only when controls have been specified and provided by Gorman-Rupp.

No express implied or statutory warranty, other than herein set forth is made or authorized to be made by Gorman-Rupp.

In no event shall The Gorman-Rupp Company be liable for consequential damages or contingent liabilities arising out of the failure of any Gorman-Rupp pump or parts thereof to operate properly.

THE GORMAN-RUPP COMPANY
Mansfield, Ohio

NOTE: In Canada, all above references to "The Gorman-Rupp Company, Mansfield, Ohio" is understood to mean "Gorman-Rupp of Canada Limited, St. Thomas, Ontario."