

**INSTALLATION, OPERATION,
AND MAINTENANCE MANUAL**
WITH PARTS LIST



10 SERIES PUMP

MODEL
14C2-F3L

THE GORMAN-RUPP COMPANY • MANSFIELD, OHIO

GORMAN-RUPP OF CANADA LIMITED • ST. THOMAS, ONTARIO, CANADA Printed in U.S.A.

©Copyright by the Gorman-Rupp Company



The engine exhaust from this product contains chemicals known to the State of California to cause cancer, birth defects or other reproductive harm.

TABLE OF CONTENTS

INTRODUCTION	PAGE I – 1
SAFETY – SECTION A	PAGE A – 1
INSTALLATION – SECTION B	PAGE B – 1
Pump Dimensions	PAGE B – 1
PREINSTALLATION INSPECTION	PAGE B – 1
Battery Specifications And Installation	PAGE B – 2
POSITIONING PUMP	PAGE B – 2
Lifting	PAGE B – 2
Mounting	PAGE B – 2
Clearance	PAGE B – 2
SUCTION AND DISCHARGE PIPING	PAGE B – 2
Materials	PAGE B – 3
Line Configuration	PAGE B – 3
Connections to Pump	PAGE B – 3
Gauges	PAGE B – 3
SUCTION LINES	PAGE B – 3
Fittings	PAGE B – 3
Strainers	PAGE B – 3
Sealing	PAGE B – 3
Suction Lines In Sumps	PAGE B – 3
Suction Line Positioning	PAGE B – 4
DISCHARGE LINES	PAGE B – 4
Siphoning	PAGE B – 4
Valves	PAGE B – 4
Bypass Lines	PAGE B – 5
AUTOMATIC AIR RELEASE VALVE	PAGE B – 6
Theory of Operation	PAGE B – 6
ALIGNMENT	PAGE B – 7
OPERATION – SECTION C	PAGE C – 1
PRIMING	PAGE C – 1
STARTING	PAGE C – 1
OPERATION	PAGE C – 1
Lines With a Bypass	PAGE C – 2
Lines Without a Bypass	PAGE C – 2
Leakage	PAGE C – 2
Liquid Temperature And Overheating	PAGE C – 2
Strainer Check	PAGE C – 2
Pump Vacuum Check	PAGE C – 2
STOPPING	PAGE C – 3
Cold Weather Preservation	PAGE C – 3
BEARING TEMPERATURE CHECK	PAGE C – 3
TROUBLESHOOTING – SECTION D	PAGE D – 1
PUMP MAINTENANCE AND REPAIR – SECTION E	PAGE E – 1
PARTS LISTS:	
Pump Model	PAGE E – 3
Pump End Assembly	PAGE E – 5

TABLE OF CONTENTS
(continued)

Drive Assembly	PAGE E - 6
PUMP AND SEAL DISASSEMBLY AND REASSEMBLY	PAGE E - 7
Back Cover Removal	PAGE E - 7
Suction Check Valve Removal	PAGE E - 7
Pump Casing Removal	PAGE E - 8
Impeller Removal	PAGE E - 8
Seal Removal and Disassembly	PAGE E - 8
Separating Intermediate And Drive Assembly From Engine	PAGE E - 8
Shaft and Bearing Removal and Disassembly	PAGE E - 9
Shaft and Bearing Reassembly and Installation	PAGE E - 10
Securing Intermediate And Drive Assembly To Engine	PAGE E - 11
Seal Reassembly and Installation	PAGE E - 11
Impeller Installation And Adjustment	PAGE E - 13
Suction Check Valve Installation	PAGE E - 13
Back Cover Installation	PAGE E - 14
Final Pump Assembly	PAGE E - 14
LUBRICATION	PAGE E - 14
Seal Assembly	PAGE E - 14
Bearings	PAGE E - 15
Engine	PAGE E - 15

INTRODUCTION

This Installation, Operation, and Maintenance manual is designed to help you achieve the best performance and longest life from your Gorman-Rupp pump.

This pump is a 10 Series, semi-open impeller, self-priming centrifugal model with a suction check valve. The pump is close-coupled to a three cylinder, air cooled Deutz diesel engine, model

F3L-912D. It is designed for handling dirty water containing specified entrained solids. The basic material of construction for wetted parts is gray iron, with ductile iron impeller and steel wearing parts.

If there are any questions regarding the pump or its application which are not covered in this manual or in other literature accompanying this unit, please contact your Gorman-Rupp distributor, or write:

The Gorman-Rupp Company
P.O. Box 1217
Mansfield, Ohio 44901-1217

or

Gorman-Rupp of Canada Limited
70 Burwell Road
St. Thomas, Ontario N5P 3R7

For information or technical assistance on the engine, contact the engine manufacturer's local dealer or representative.

The following are used to alert maintenance personnel to procedures which require special attention, to those which could damage equipment, and to those which could be dangerous to personnel:



Immediate hazards which WILL result in severe personal injury or death. These instructions describe the procedure required and the injury which will result from failure to follow the procedure.

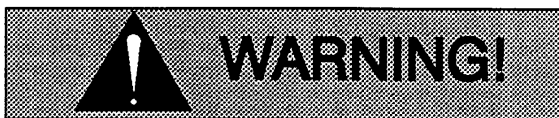

Hazards or unsafe practices which COULD result in severe personal injury or death. These instructions describe the procedure required and the injury which could result from failure to follow the procedure.



Hazards or unsafe practices which COULD result in minor personal injury or product or property damage. These instructions describe the requirements and the possible damage which could result from failure to follow the procedure.

NOTE

Instructions to aid in installation, operation, and maintenance, or which clarify a procedure.

SAFETY – SECTION A

This information applies to 10 Series engine driven pumps. Refer to the manual accompanying the engine before attempting to begin operation.

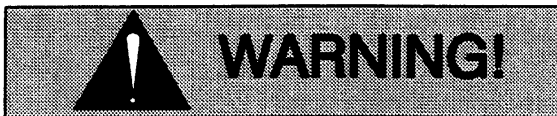

Before attempting to open or service the pump:

1. Familiarize yourself with this manual.
2. Switch off the engine ignition and disconnect the positive battery cable. Take other precautions to ensure that the pump will remain inoperative.
3. Allow the pump to completely cool if overheated.
4. Check the temperature before opening any covers, plates, or plugs.
5. Close the suction and discharge valves.
6. Vent the pump slowly and cautiously.
7. Drain the pump.

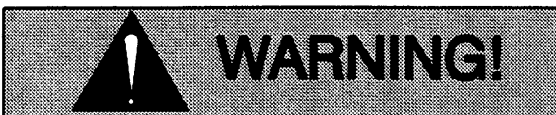

This pump is designed to handle dirty water containing specified entrained solids. Do not attempt to pump volatile, corrosive, or flammable materials, or any liquids which may damage the pump or endanger personnel as a result of pump failure.

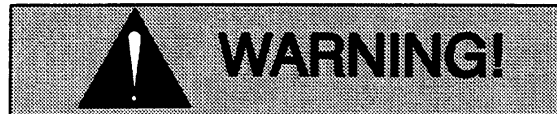

Use lifting and moving equipment in good repair and with adequate capacity to prevent injuries to personnel or damage to equipment. Suction and discharge hoses and piping must be removed from the pump before lifting.

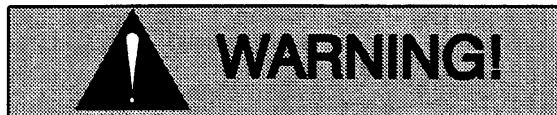

After the pump has been positioned, make certain that the pump and all piping or hose connections are tight, properly supported and secure before operation.

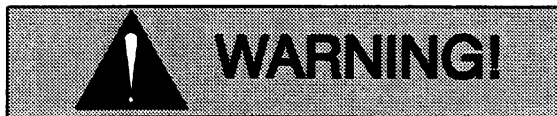

Do not operate the pump against a closed discharge valve for long periods of time. If operated against a closed discharge valve, pump components will deteriorate, and the liquid could come to a boil, build pressure, and cause the pump casing to rupture or explode.

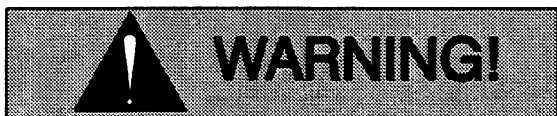

Do not remove plates, covers, gauges, pipe plugs, or fittings from an overheated pump. Vapor pressure within the pump can cause parts being disengaged to be ejected with great force. Allow the pump to cool before servicing.



Do not operate an internal combustion engine in an explosive atmosphere. When operating internal combustion engines in an enclosed area, make certain that exhaust fumes are piped to the outside. These fumes contain carbon monoxide, a deadly gas that is colorless, tasteless, and odorless.



Fuel used by internal combustion engines presents an extreme explosion and fire hazard. Make certain that all fuel lines are securely connected and free of leaks. Never refuel a hot or running engine. Avoid overfilling the fuel tank. Always use the correct type of fuel.



Never tamper with the governor to gain more power. The governor establishes safe operating limits that should not be exceeded. The maximum continuous operating speed for this pump is 2300 RPM.

INSTALLATION - SECTION B

Review all SAFETY information in Section A.

Since pump installations are seldom identical, this section offers only general recommendations and practices required to inspect, position, and arrange the pump and piping.

Most of the information pertains to a standard **static lift application where the pump is positioned above the free level of liquid to be pumped.**

If installed in a **flooded suction application** where the liquid is supplied to the pump under pressure, some of the information such as mounting, line configuration, and priming must be tailored to the specific application. Since the pressure supplied to the

pump is critical to performance and safety, **be sure** to limit the incoming pressure to **50%** of the maximum permissible operating pressure as shown on the pump performance curve (see Section E, Page 1). If the pump is fitted with a Gorman-Rupp double grease lubricated seal, the maximum incoming pressure must be reduced to 10 p.s.i.

For further assistance, contact your Gorman-Rupp distributor or the Gorman-Rupp Company.

Pump Dimensions

See Figure 1 for the approximate physical dimensions of this pump and engine.

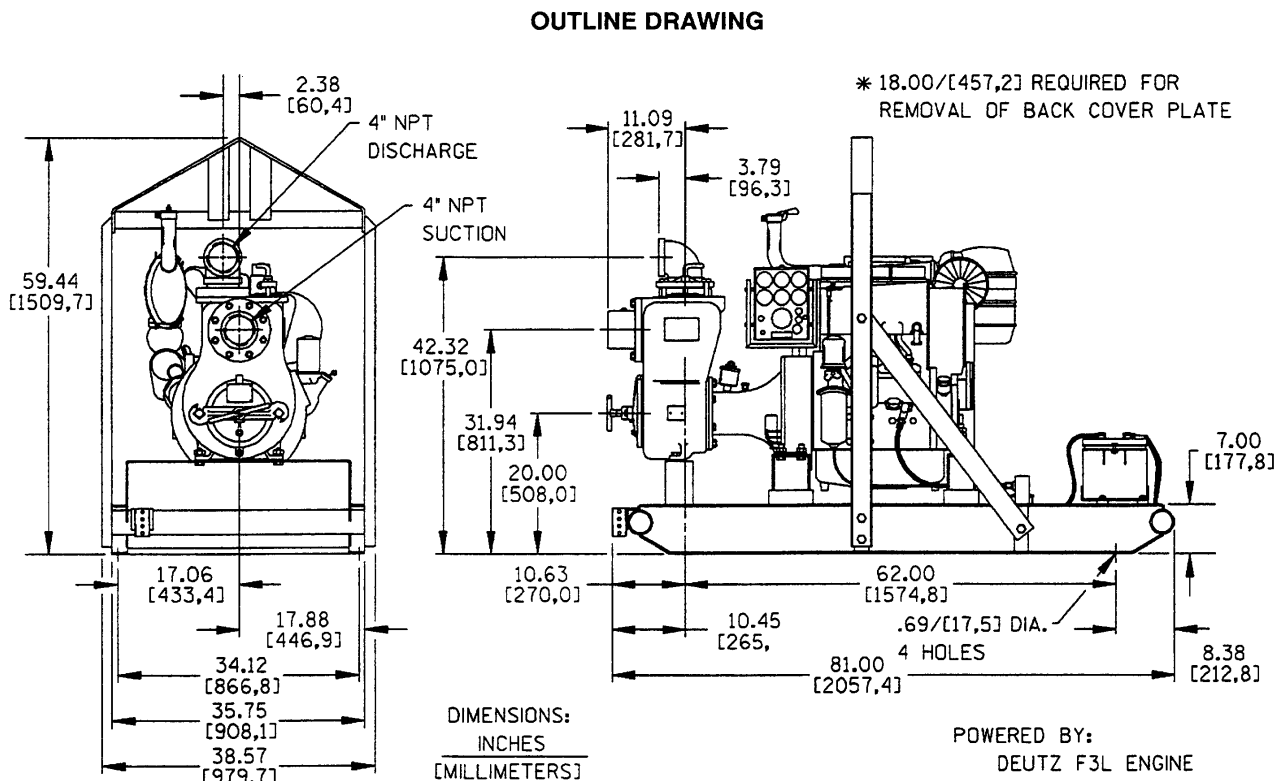

Figure 1. Pump Model 14C2-F3L

PREINSTALLATION INSPECTION

The pump assembly was inspected and tested before shipment from the factory. Before installation, inspect the pump for damage which may have occurred during shipment. Check as follows:

- a. Inspect the pump for cracks, dents, damaged threads, and other obvious damage.
- b. Check for and tighten loose attaching hardware. Since gaskets tend to shrink after drying, check for loose hardware at mating surfaces.

- c. Carefully read all warnings and cautions contained in this manual or affixed to the pump, and perform all duties indicated.
- d. Check levels and lubricate as necessary. Refer to **LUBRICATION** in the **MAINTENANCE AND REPAIR** section of this manual and perform duties as instructed.
- e. If the pump has been stored for more than 12 months, some of the components or lubricants may have exceeded their maximum shelf life. These **must be inspected or replaced** to ensure maximum pump service.

If the maximum shelf life has been exceeded, or if anything appears to be abnormal, contact your Gorman-Rupp distributor or the factory to determine the repair or updating policy. **Do not** put the pump into service until appropriate action has been taken.

Battery Specifications And Installation

Unless otherwise specified on the pump order, the engine battery was **not** included with the unit. Refer to the following specifications when selecting a battery.

Voltage	Cold Crank Amps @ 0°F	Reserve Capacity @80°F (Minutes)	Amp/ Hr. Rating	Approx. Overall Dims. (Inches)
12 Volts	960-975	365	175	20.5L x 8.75W x 9.75H

Table 1. Battery Specifications

Refer to the information accompanying the battery and/or electrolyte solution for activation and charging instructions.

Before installing the battery, clean the positive and negative cable connectors, and the battery terminals. Secure the battery by tightening the holddown brackets. The terminals and clamps may be coated with petroleum jelly to retard corrosion. Connect and tighten the positive cable first, then the negative cable.

POSITIONING PUMP

Lifting

Use lifting equipment with a capacity of at least **8,690 pounds (3941,7 kg)**. This pump weighs approximately **1,738 pounds (788,3 kg)**, not including the weight of accessories and customer installed options and accessories. Customer installed equipment such as suction and discharge piping **must** be removed before attempting to lift.



The pump assembly can be seriously damaged if the cables or chains used to lift and move the unit are improperly wrapped around the pump.

After mounting the pump end to the engine and base, use lifting equipment with a capacity of at least **5 times** the weight of the complete unit.

Mounting

Locate the pump in an accessible place as close as practical to the liquid being pumped. Level mounting is essential for proper operation.

The pump may have to be supported or shimmed to provide for level operation or to eliminate vibration.

To ensure sufficient lubrication and fuel supply to the engine, **do not** position the pump and engine more than 15° off horizontal for continuous operation. The pump and engine may be positioned up to 30° off horizontal for **intermittent operation only**; however, the engine manufacturer should be consulted for continuous operation at angles greater than 15°.

Clearance

When positioning the pump, allow a minimum clearance of **18 inches (457 mm)** in front of the back cover to permit removal of the cover and easy access to the pump interior.

SUCTION AND DISCHARGE PIPING

Pump performance is adversely effected by increased suction lift, discharge elevation, and fric-

tion losses. Contact the factory to be sure your overall application allows the pump to operate within the safe operation range.

Materials

Either pipe or hose may be used for suction and discharge lines; however, the materials must be compatible with the liquid being pumped. If hose is used in suction lines, it must be the rigid-wall, reinforced type to prevent collapse under suction. Using piping couplings in suction lines is not recommended.

Line Configuration

Keep suction and discharge lines as straight as possible to minimize friction losses. Make minimum use of elbows and fittings, which substantially increase friction loss. If elbows are necessary, use the long-radius type to minimize friction loss.

Connections to Pump

Before tightening a connecting flange, align it exactly with the pump port. Never pull a pipe line into place by tightening the flange bolts and/or couplings.

Lines near the pump must be independently supported to avoid strain on the pump which could cause excessive vibration, decreased bearing life, and increased shaft and seal wear. If hose-type lines are used, they should have adequate support to secure them when filled with liquid and under pressure.

Gauges

Most pumps are drilled and tapped for installing discharge pressure and vacuum suction gauges. If these gauges are desired for pumps that are not tapped, drill and tap the suction and discharge lines not less than 18 inches (457,2 mm) from the suction and discharge ports and install the lines. Installation closer to the pump may result in erratic readings.

SUCTION LINES

To avoid air pockets which could affect pump priming, the suction line must be as short and direct as possible. When operation involves a suction lift, the line must always slope upward to the pump from the source of the liquid being pumped; if the line slopes down to the pump at any point along the suction run, air pockets will be created.

Fittings

Suction lines should be the same size as the pump inlet. If reducers are used in suction lines, they should be the eccentric type, and should be installed with the flat part of the reducers uppermost to avoid creating air pockets. Valves are not normally used in suction lines, but if a valve is used, install it with the stem horizontal to avoid air pockets.

Strainers

If a strainer is furnished with the pump, be certain to use it; any spherical solids which pass through a strainer furnished with the pump will also pass through the pump itself.

If a strainer is not furnished with the pump, but is installed by the pump user, make certain that the total area of the openings in the strainer is at least three or four times the cross section of the suction line, and that the openings will not permit passage of solids larger than the solids handling capability of the pump.

This pump is designed to handle up to 3 inch (76,2 mm) diameter spherical solids.

Sealing

Since even a slight leak will affect priming, head, and capacity, especially when operating with a high suction lift, all connections in the suction line should be sealed with pipe dope to ensure an airtight seal. Follow the sealant manufacturer's recommendations when selecting and applying the pipe dope. The pipe dope should be compatible with the liquid being pumped.

Suction Lines In Sumps

If a single suction line is installed in a sump, it should be positioned away from the wall of the

sump at a distance equal to 1 1/2 times the diameter of the suction line.

If there is a liquid flow from an open pipe into the sump, the flow should be kept away from the suction inlet because the inflow will carry air down into the sump, and air entering the suction line will reduce pump efficiency.

If it is necessary to position inflow close to the suction inlet, install a baffle between the inflow and the suction inlet at a distance 1 1/2 times the diameter of the suction pipe. The baffle will allow entrained air to escape from the liquid before it is drawn into the suction inlet.

If two suction lines are installed in a single sump, the flow paths may interact, reducing the efficiency of one or both pumps. To avoid this, position the suction inlets so that they are separated by a dis-

tance equal to at least 3 times the diameter of the suction pipe.

Suction Line Positioning

The depth of submergence of the suction line is critical to efficient pump operation. Figure 1 shows recommended minimum submergence vs. velocity.

NOTE

The pipe submergence required may be reduced by installing a standard pipe increaser fitting at the end of the suction line. The larger opening size will reduce the inlet velocity. Calculate the required submergence using the following formula based on the increased opening size (area or diameter).

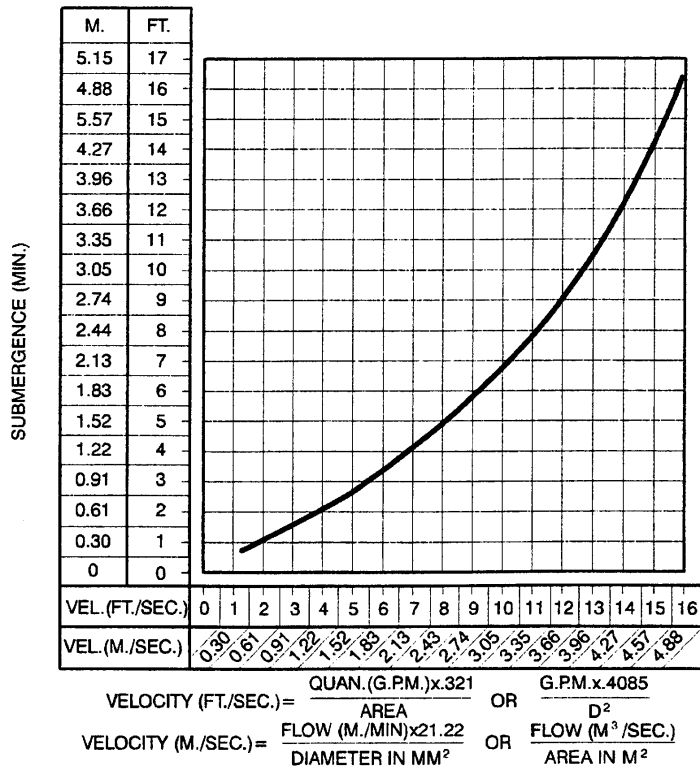

Figure 1. Recommended Minimum Suction Line Submergence vs. Velocity

DISCHARGE LINES

Siphoning

Do not terminate the discharge line at a level lower than that of the liquid being pumped unless a siphon breaker is used in the line. Otherwise, a si-

phoning action causing damage to the pump could result.

Valves

If a throttling valve is desired in the discharge line, use a valve as large as the largest pipe to minimize

friction losses. Never install a throttling valve in a suction line.

With high discharge heads, it is recommended that a throttling valve and a system check valve be installed in the discharge line to protect the pump from excessive shock pressure and reverse rotation when it is stopped.



If the application involves a high discharge head, gradually close the discharge throttling valve before stopping the pump.

Bypass Lines

Self-priming pumps are not air compressors. During the priming cycle, air from the suction line must be vented to atmosphere on the discharge side. If the discharge line is open, this air will be vented through the discharge. However, if a check valve has been installed in the discharge line, the discharge side of the pump must be opened to atmospheric pressure through a bypass line installed between the pump discharge and the check valve. A self-priming centrifugal pump **will not prime** if there is sufficient static liquid head to hold the discharge check valve closed.

NOTE

The bypass line should be sized so that it does not affect pump discharge capacity; however, the bypass line should be at least 1 inch (25,4 mm) in diameter to minimize the chance of plugging.

In **low discharge head applications** (less than 30 feet (9,1 m)), it is recommended that the bypass line be run back to the wet well, and located 6 inches below the water level or cut-off point of the low level pump. In some installations, this bypass outline may be terminated with a six-to-eight foot (1,8 to 2,4 m) length of 1-1/4 inch (31,8 mm) I.D. **smooth-bore** hose; air and liquid vented during the priming process will then agitate the hose and break up any solids, grease, or other substances likely to cause clogging.

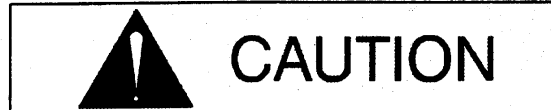

A bypass line that is returned to a wet well must be secured against being drawn into the pump suction inlet.

It is also recommended that pipe unions be installed at each 90° elbow in a bypass line to ease disassembly and maintenance.

In **high discharge head applications** (more than 30 feet (9,1 m)), an excessive amount of liquid may be bypassed and forced back to the wet well under the full working pressure of the pump; this will reduce overall pumping efficiency. **Therefore, it is recommended that a Gorman-Rupp Automatic Air Release Valve be installed in the bypass line.**

Gorman-Rupp Automatic Air Release Valves are reliable, and require minimum maintenance. See **Automatic Air Release Valves** in this section for installation and theory of operation of the Automatic Air Release Valve. Consult your Gorman-Rupp distributor, or contact the Gorman-Rupp Company for selection of an Automatic Air Release Valve to fit your application.

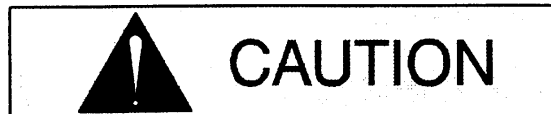

Except in certain specific applications (to prevent flooding during service of an automatic air release valve in a below-ground lift station), if a manual shut-off valve is installed **anywhere** in a bypass line, it **must** be a full-opening, **ball-type** valve to prevent plugging by solids.

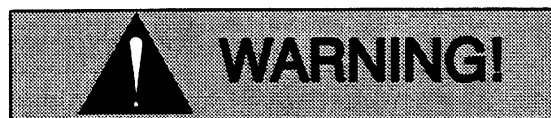

A manual shut-off valve should not be installed in any bypass line. A manual shut-off valve may inadvertently be left closed during operation. A pump which has lost prime may continue to operate without reaching prime, causing dangerous overheating and possible explosive rupture of the pump casing. Per-

sonnel could be severely injured.

Allow an over-heated pump to cool before servicing. Do not remove plates, covers, gauges, or fittings from an over-heated pump. Liquid within the pump can reach boiling temperatures, and vapor pressure within the pump can cause parts being disengaged to be ejected with great force. After the pump cools, drain the liquid from the pump by removing the casing drain plug. Use caution when removing the plug to prevent injury to personnel from hot liquid.

AUTOMATIC AIR RELEASE VALVE

When properly installed and correctly adjusted to the specific hydraulic operating conditions of the application, the Gorman-Rupp Automatic Air Release Valve will permit air to escape through the bypass line, and then close automatically when the pump is fully primed and pumping at full capacity.

Theory of Operation

Figures 3 and 4 show a cross-sectional view of the Automatic Air Release Valve, and a corresponding description of operation.

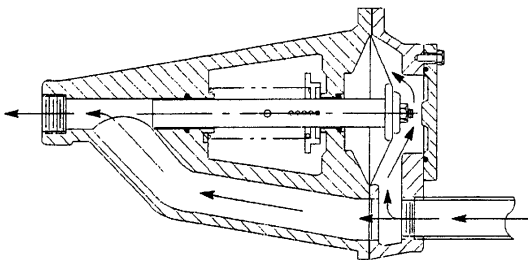

Figure 3. Valve in Open Position

During the priming cycle, air from the pump casing flows through the bypass line, and passes through the Air Release Valve to the wet well (Figure 3).

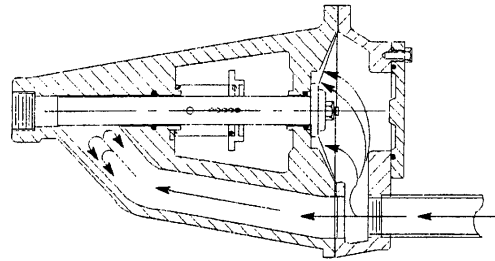
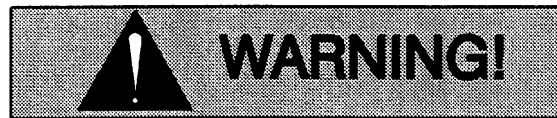

Figure 4. Valve in Closed Position

When the pump is fully primed, pressure resulting from flow against the valve diaphragm compresses the spring and closes the valve (Figure 4). The valve will remain closed, reducing the bypass of liquid to 1 to 5 gallons per minute, until the pump loses its prime or stops.



Some leakage (1 to 5 gallons (3,8 to 18,9 Liters) per minute) will occur when the valve is fully closed. Be sure the bypass line is directed back to the wet well or tank to prevent hazardous spills.

When the pump shuts down, the spring returns the diaphragm to its original position. Any solids that may have accumulated in the diaphragm chamber settle to the bottom and are flushed out during the next priming cycle.

NOTE

The valve will remain open if the pump does not reach its designed capacity or head. Valve closing pressure is dependent upon the discharge head of the pump at full capacity. The range of the valve closing pressure is established by the tension rate of the spring as ordered from the factory. Valve closing pressure can be further adjusted to the exact system requirements by moving the spring retaining pin up or down the plunger rod to increase or decrease tension on the spring. Contact your Gorman-Rupp distributor or the Gorman-Rupp Company for information about an Automatic Air Release Valve for your specific application.

Air Release Valve Installation

The Automatic Air Release Valve must be independently mounted in a horizontal position and connected to the discharge line of the self-priming centrifugal pump (see Figure 5).

NOTE

If the Air Release Valve is to be installed on a **staged** pump application, contact the factory for specific installation instructions.

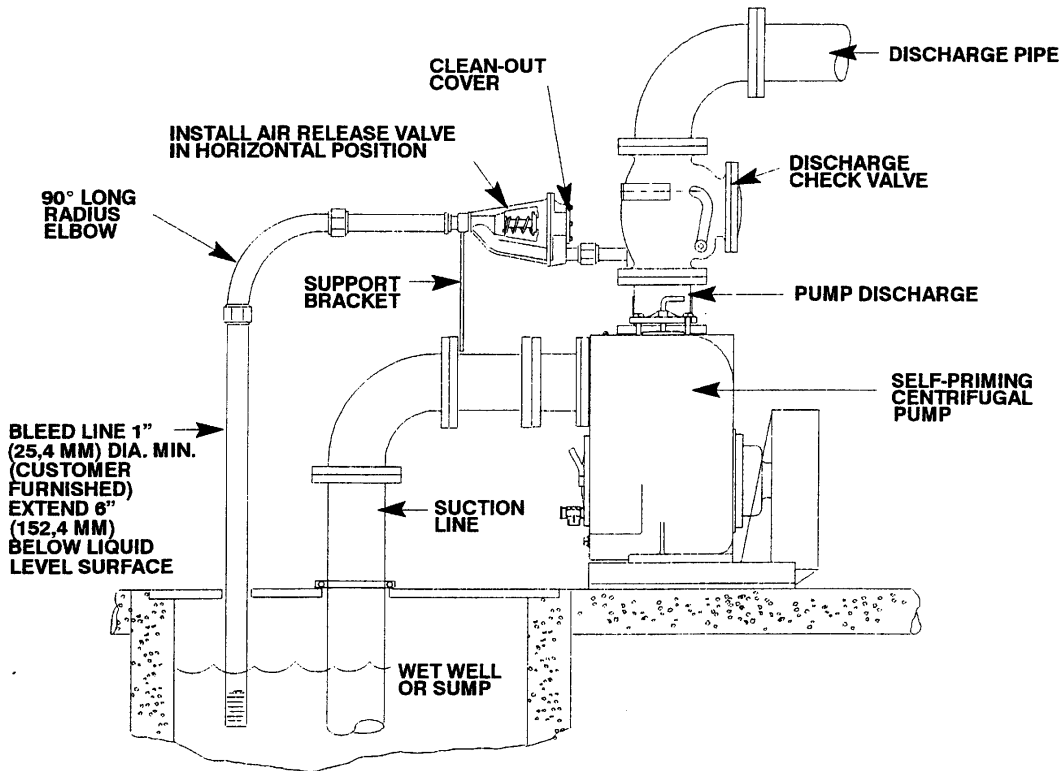

Figure 5. Typical Automatic Air Release Valve Installation

The valve inlet line must be installed between the pump discharge port and the non-pressurized side of the discharge check valve. The valve inlet is at the large end of the valve body, and is provided with standard 1 inch NPT pipe threads.

The valve outlet is located at the opposite end of the valve, and is also equipped with standard 1 inch NPT pipe threads. The outlet should be connected to a bleed line which slopes back to the wet well or sump. The bleed line must be the same size as the inlet piping, or larger. If piping is used for the bleed line, avoid the use of elbows whenever possible.

NOTE

It is recommended that each Air Release Valve be fitted with an independent bleeder line directed back to the wet well. However, if multiple Air Release Valves are installed in a system, the bleeder lines may be directed to a common manifold pipe. Contact your Gorman-Rupp distributor or the Gorman-Rupp Company for information about installation of an Automatic Air Release Valve for your specific application.

ALIGNMENT

The alignment of the pump and the engine is critical for trouble-free mechanical operation. See Section E, **Securing Intermediate And Drive Assembly To Engine** for detailed information.

OPERATION – SECTION C

Review all SAFETY information in Section A.

Follow the instructions on all tags, labels and decals attached to the pump.



This pump is designed to handle dirty water containing specified entrained solids. Do not attempt to pump volatile, corrosive, or flammable materials, or any liquids which may damage the pump or endanger personnel as a result of pump failure.



Never tamper with the governor to gain more power. The governor establishes safe operating limits that should not be exceeded. The maximum continuous operating speed for this pump is 2300 RPM.

PRIMING

Install the pump and piping as described in **INSTALLATION**. Make sure that the piping connections are tight, and that the pump is securely mounted. Check that the pump is properly lubricated (see **LUBRICATION** in **MAINTENANCE AND REPAIR**).

This pump is self-priming, but the pump should never be operated unless there is liquid in the pump casing.



Never operate this pump unless there is liquid in the pump casing. The pump will not

prime when dry. Extended operation of a dry pump will destroy the seal assembly.

Add liquid to the pump casing when:

1. The pump is being put into service for the first time.
2. The pump has not been used for a considerable length of time.
3. The liquid in the pump casing has evaporated.

Once the pump casing has been filled, the pump will prime as necessary.



After filling the pump casing, reinstall and tighten the fill plug. Do not attempt to operate the pump unless all connecting piping is securely installed. Otherwise, liquid in the pump forced out under pressure could cause injury to personnel.

To fill the pump, remove the pump casing fill cover or fill plug in the top of the casing, and add clean liquid until the casing is filled. Replace the fill cover or fill plug before operating the pump.

STARTING

Consult the operations manual furnished with the engine.

OPERATION

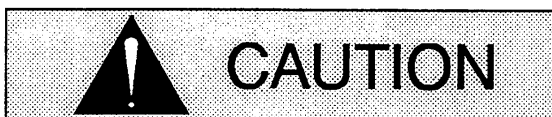

Pump speed and operating condition points must be within the continuous performance range shown on the curve (see Section E, Page 1).

Lines With a Bypass

Close the discharge throttling valve (if so equipped) so that the pump will not have to prime against the weight of the liquid in the discharge line. Air from the suction line will be discharged through the bypass line back to the wet well during the priming cycle. When the pump is fully primed and liquid is flowing steadily from the bypass line, open the discharge throttling valve. Liquid will then continue to circulate through the bypass line while the pump is in operation.

Lines Without a Bypass

Open all valves in the discharge line and start the engine. Priming is indicated by a positive reading on the discharge pressure gauge or by a quieter operation. The pump may not prime immediately because the suction line must first fill with liquid. If the pump fails to prime within five minutes, stop it and check the suction line for leaks.

After the pump has been primed, partially close the discharge line throttling valve in order to fill the line slowly and guard against excessive shock pressure which could damage pipe ends, gaskets, sprinkler heads, and any other fixtures connected to the line. When the discharge line is completely filled, adjust the throttling valve to the required flow rate.

Leakage

No leakage should be visible at pump mating surfaces, or at pump connections or fittings. Keep all line connections and fittings tight to maintain maximum pump efficiency.

Liquid Temperature And Overheating

The **maximum** liquid temperature for this pump is 110° F (43°C). Do not apply it at a higher operating temperature.

Overheating can occur if operated with the valves in the suction or discharge lines closed. Operating against closed valves could bring the liquid to a boil, build pressure, and cause the pump to rupture or explode. If overheating occurs, stop the pump and allow it to cool before servicing it. Refill the pump casing with cool liquid.



Do not remove plates, covers, gauges, pipe plugs, or fittings from an overheated pump. Vapor pressure within the pump can cause parts being disengaged to be ejected with great force. Allow the pump to completely cool before servicing.

Strainer Check

If a suction strainer has been shipped with the pump or installed by the user, check the strainer regularly, and clean it as necessary. The strainer should also be checked if pump flow rate begins to drop. If a vacuum suction gauge has been installed, monitor and record the readings regularly to detect strainer blockage.

Never introduce air or steam pressure into the pump casing or piping to remove a blockage. This could result in personal injury or damage to the equipment. If backflushing is absolutely necessary, **liquid pressure** must be limited to 50% of the maximum permissible operating pressure shown on the pump performance curve (see Section E, Page 1). If the pump is fitted with a Gorman-Rupp double grease lubricated seal, the maximum incoming pressure must be reduced to 10 p.s.i.

Pump Vacuum Check

With the pump inoperative, install a vacuum gauge in the system, using pipe dope on the threads. Block the suction line and start the pump. At operating speed the pump should pull a vacuum of 20 inches (508,0 mm) or more of mercury. If it does not, check for air leaks in the seal, gasket, or discharge valve.

Open the suction line, and read the vacuum gauge with the pump primed and at operation speed. Shut off the pump. The vacuum gauge reading will immediately drop proportionate to static suction lift, and should then stabilize. If the vacuum reading falls off rapidly after stabilization, an air leak exists. Before checking for the source of the leak, check the point of installation of the vacuum gauge.

STOPPING

Never halt the flow of liquid suddenly. If the liquid being pumped is stopped abruptly, damaging shock waves can be transmitted to the pump and piping system. Close all connecting valves slowly.

On engine driven pumps, reduce the throttle speed slowly and allow the engine to idle briefly before stopping.



If the application involves a high discharge head, gradually close the discharge throttling valve before stopping the pump.

After stopping the pump, remove the engine ignition key to ensure that the pump will remain inoperative.

Cold Weather Preservation

In below freezing conditions, drain the pump to prevent damage from freezing. Also, clean out any solids by flushing with a hose. Operate the pump for approximately one minute; this will remove any remaining liquid that could freeze the pump rotating parts. If the pump will be idle for more than a few hours, or if it has been pumping liquids containing a large amount of solids, drain the pump, and flush it

thoroughly with clean water. To prevent large solids from clogging the drain port and preventing the pump from completely draining, insert a rod or stiff wire in the drain port, and agitate the liquid during the draining process. Clean out any remaining solids by flushing with a hose.

BEARING TEMPERATURE CHECK

Bearings normally run at higher than ambient temperatures because of heat generated by friction. Temperatures up to 160°F (71°C) are considered normal for bearings, and they can operate safely to at least 180°F (82°C).

Checking bearing temperatures by hand is inaccurate. Bearing temperatures can be measured accurately by placing a contact-type thermometer against the housing. Record this temperature for future reference.

A sudden increase in bearing temperatures is a warning that the bearings are at the point of failing to operate properly. Make certain that the bearing lubricant is of the proper viscosity and at the correct level (see **LUBRICATION** in Section E). Bearing overheating can also be caused by shaft misalignment and/or excessive vibration.

When pumps are first started, the bearings may seem to run at temperatures above normal. Continued operation should bring the temperatures down to normal levels.

TROUBLESHOOTING – SECTION D

Review all SAFETY information in Section A.



Before attempting to open or service the pump:

1. Familiarize yourself with this manual.
2. Switch off the engine ignition and disconnect the positive battery cable. Take other precautions to ensure that the pump will remain inoperative.
3. Allow the pump to completely cool if overheated.
4. Check the temperature before opening any covers, plates, or plugs.
5. Close the suction and discharge valves.
6. Vent the pump slowly and cautiously.
7. Drain the pump.

TROUBLE	POSSIBLE CAUSE	PROBABLE REMEDY
PUMP FAILS TO PRIME	Not enough liquid in casing. Suction check valve contaminated or damaged. Air leak in suction line. Lining of suction hose collapsed. Leaking or worn seal or pump gasket. Suction lift or discharge head too high. Strainer clogged. Suction check valve or foot valve clogged or binding.	Add liquid to casing. See PRIMING . Clean or replace check valve. Correct leak. Replace suction hose. Check pump vacuum. Replace leaking or worn seal or gasket. Check piping installation and install bypass line if needed. See INSTALLATION . Check strainer and clean if necessary. Clean valve.
PUMP STOPS OR FAILS TO DELIVER RATED FLOW OR PRESSURE	Air leak in suction line. Lining of suction hose collapsed. Leaking or worn seal or pump gasket. Strainer clogged.	Correct leak. Replace suction hose. Check pump vacuum. Replace leaking or worn seal or gasket. Check strainer and clean if necessary.

TROUBLE	POSSIBLE CAUSE	PROBABLE REMEDY
PUMP STOPS OR FAILS TO DELIVER RATED FLOW OR PRESSURE (cont.)	<p>Suction intake not submerged at proper level or sump too small.</p> <p>Impeller or other wearing parts worn or damaged.</p> <p>Impeller clogged.</p> <p>Pump speed too slow.</p> <p>Suction lift or discharge head too high.</p>	<p>Check installation and correct submergence as needed.</p> <p>Replace worn or damaged parts. Check that impeller is properly centered and rotates freely.</p> <p>Free impeller of debris.</p> <p>Check engine output; consult engine operation manual.</p> <p>Check piping installation and install bypass line if needed. See INSTALLATION.</p>
PUMP REQUIRES TOO MUCH POWER	<p>Pump speed too high.</p> <p>Discharge head too low.</p> <p>Liquid solution too thick.</p> <p>Bearing(s) frozen.</p>	<p>Check engine output.</p> <p>Adjust discharge valve.</p> <p>Dilute if possible.</p> <p>Disassemble pump and check bearing(s).</p>
PUMP CLOGS FREQUENTLY	<p>Liquid solution too thick.</p> <p>Discharge flow too slow.</p> <p>Discharge line clogged or restricted; hose kinked.</p> <p>Suction check valve or foot valve clogged or binding.</p>	<p>Dilute if possible.</p> <p>Open discharge valve fully to increase flow rate, and run power source at maximum governed speed.</p> <p>Check discharge lines; straighten hose.</p> <p>Clean valve.</p>
EXCESSIVE NOISE	<p>Cavitation in pump.</p> <p>Pumping entrained air.</p> <p>Pump or drive not securely mounted.</p> <p>Impeller clogged or damaged.</p>	<p>Reduce suction lift and/or friction losses in suction line. Record vacuum and pressure gauge readings and consult local representative or factory.</p> <p>Locate and eliminate source of air bubble.</p> <p>Secure mounting hardware.</p> <p>Clean out debris; replace damaged parts.</p>
BEARINGS RUN TOO HOT	<p>Bearing temperature is high, but within limits.</p> <p>Low or incorrect lubricant</p> <p>Suction and discharge lines not properly supported.</p> <p>Drive misaligned.</p>	<p>Check bearing temperature regularly to monitor any increase.</p> <p>Check for proper type and level of lubricant.</p> <p>Check piping installation for proper support.</p> <p>Align drive properly.</p>

PUMP MAINTENANCE AND REPAIR - SECTION E

MAINTENANCE AND REPAIR OF THE WEARING PARTS OF THE PUMP WILL MAINTAIN PEAK OPERATING PERFORMANCE.

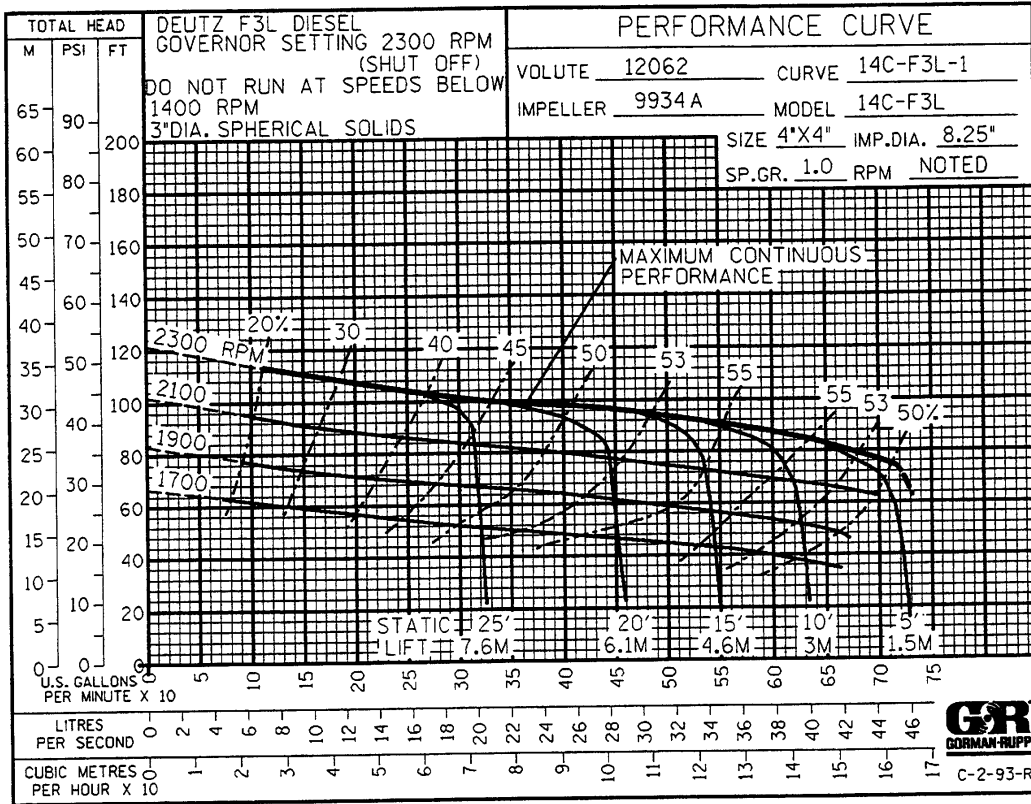

*** STANDARD PERFORMANCE FOR PUMP MODEL 14C2-F3L**

* Based on 70° F (21° C) clear water at sea level with minimum suction lift. Since pump installations are seldom identical, your performance may be different due to such factors as viscosity, specific gravity, elevation, temperature, and impeller trim.

If your pump serial number is followed by an "N", your pump is **NOT** a standard production model.

Contact the Gorman-Rupp Company to verify part numbers.



Pump speed and operating condition points must be within the continuous performance range shown on the curve.

PARTS LIST
Pump Model 14C2-F3L
 (From S/N 1015723 up)

If your pump serial number is followed by an "N", your pump is **NOT** a standard production model. Contact the Gorman-Rupp Company to verify part numbers.

ITEM NO.	PART NAME	PART NUMBER	MAT'L CODE	QTY	ITEM NO.	PART NAME	PART NUMBER	MAT'L CODE	QTY
1	PUMP END	14C2-(SAE 4/10)		1	32	-FLANGED HEX NUT	21765-314	----	6
2	CAUTION DECAL	2613FJ	----	2	33	-FUEL TANK ASSY	46711-042	24150	1
3	TACHOMETER KIT	48312-606	----	1	34	-FUEL TANK GRD	34851-178	15080	1
	-TACHOMETER	26861-021	----	1	35	HOSE INLET ASSY	46341-800	----	1
4	EXHAUST ELBOW	31912-023	15990	1	36	MALE CONNECTOR	S1447	----	1
5	WEATHER CAP	S1331	----	1	37	HEX HD CAPSCREW	B1017	15991	2
6	MUFFLER GUARD ASSY	42331-029	----	1	38	LOCKWASHER	J10	15991	2
7	HOISTING BAIL	13351BB	24000	1	39	HEX NUT	D10	15991	2
8	FUEL RETURN LINE	11308F	----	1	40	HEX HD CAPSCREW	B1006	15991	8
9	HOSE CLAMP	26518-641	----	2	41	LOCKWASHER	J10	15991	8
10	HOSE BARB FITTING	26523-443	----	1	42	HEX NUT	D10	15991	8
11	MALE CONNECTOR	26523-382	----	1	43	HEX HD CAPSCREW	B1007	15991	4
12	REDUCING ELBOW	Q0402	11999	1	44	LOCKWASHER	J10	15991	4
13	FUEL RETURN LINE	14294	24030	1	45	HEX NUT	D10	15991	4
14	DEUTZ F3L ENGINE	29217-021	----	1	46	COMBINATION BASE	41566-667	24150	1
15	POS CABLE ASSY	47311-114	----	1	47	HEX HD CAPSCREW	B0807	15991	2
16	BATTERY BOX ASSY	GRP40-08C	----	1	48	LOCKWASHER	J08	15991	2
17	-HEX HD CAPSCREW	B0607	15991	2	49	HEX NUT	D08	15991	2
18	-FLAT WASHER	K06	15991	2	50	FLAT WASHER	K08	15991	2
19	-FLANGED HEX NUT	21765-314	15991	2	51	HALF UNION	S305	----	1
20	-BATTERY BOX COVER	42113-012	24150	1		NOT SHOWN:			
21	-BATTERY BOX	42431-030	24150	1		BELT/FAN GUARD KIT	48157-701	----	1
22	-GROUND CABLE ASSY	47311-064	----	1		CONTROL PANEL	29277-011	----	1
23	-BATTERY TAG	38818-506	----	1		OPTIONAL:			
24	-12V BATTERY	SEE OPTIONS		REF		* 12V BATTERY	29331-506	----	1
25	-FLANGED HEX NUT	21765-314	----	8		WHEEL KIT	GRP30-248F	----	1
26	-STUD MOUNT	24631-006	----	4		BELT GRD ANTI-VIBE KIT	48217-801	----	1
27	HEX HD CAPSCREW	B0604	15991	10		ENG/PUMP ANTI-VIBE KIT	48217-802	----	1
28	FLANGED HEX NUT	21765-314	----	10		VACUUM GAUGE KIT	48312-204	----	1
29	FUEL TANK & GRD ASSY	46711-041	----	1					
30	-FLAT WASHER	K06	15991	6					
31	-CARRIAGE BOLT	AB0604	15991	6					

* INDICATES PARTS RECOMMENDED FOR STOCK

Above Serial Numbers Do Not Apply To Pumps Made In Canada.

CANADIAN SERIAL NO. AND UP

SECTION DRAWING

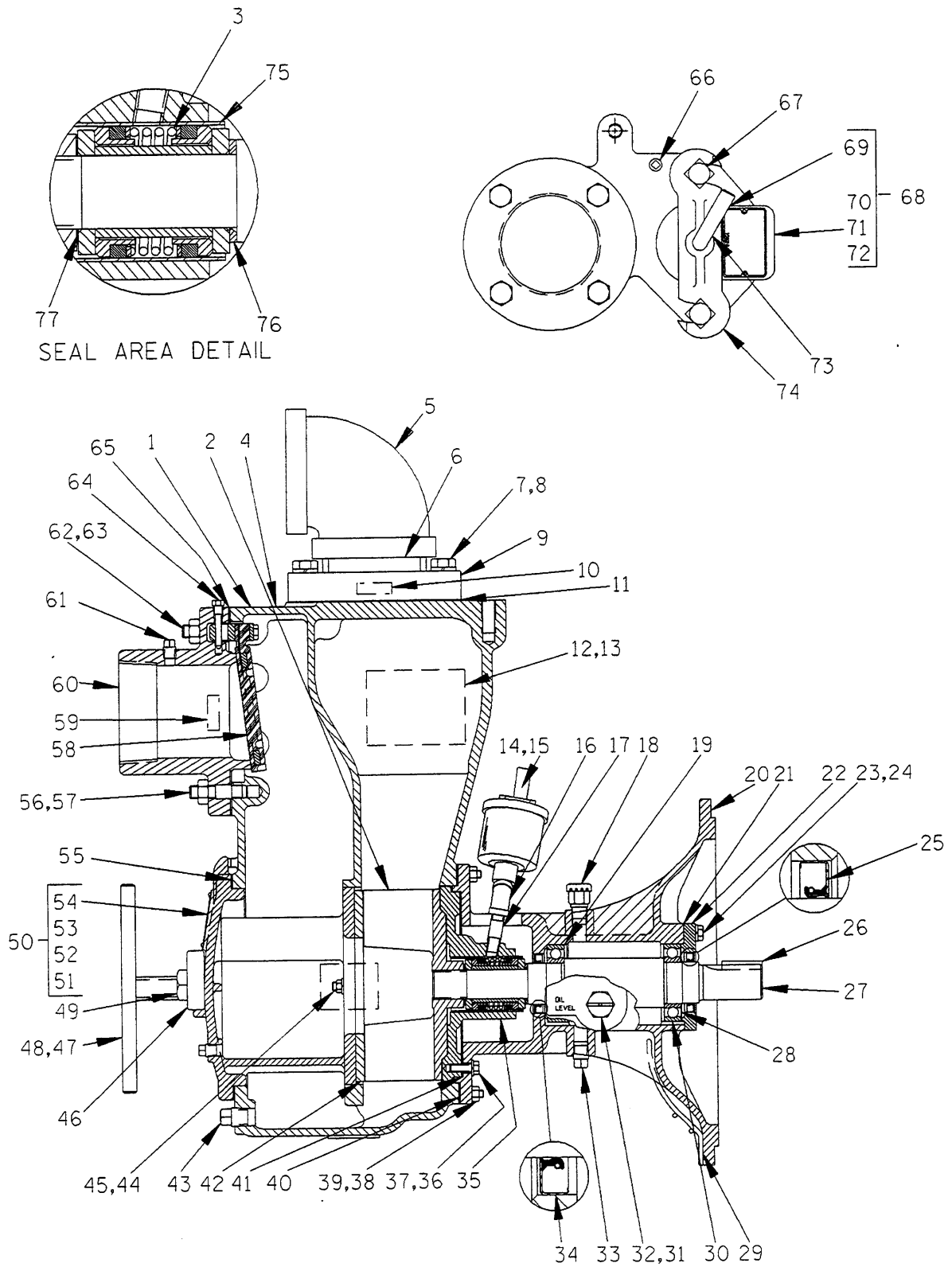

Figure 2. 14C2-(SAE 4/10) Pump End Assembly

PARTS LIST
14C2-(SAE 4/10) Pump End Assembly

ITEM NO.	PART NAME	PART NUMBER	MAT'L CODE	QTY	ITEM NO.	PART NAME	PART NUMBER	MAT'L CODE	QTY
1	PUMP CASING	12062	10010	1	42 *	WEAR PLATE ASSY	12068	15990	1
2 *	IMPELLER	9934A	11060	1	43	PIPE PLUG	P08	15079	1
3 *	SEAL ASSEMBLY	GS1250	-----	1	44	LOCKWASHER	J06	15991	2
4	PRIMING STICKER	6588AH	-----	1	45	HEX NUT	D06	15991	2
5	DISCHARGE ELBOW	R64	11990	1	46	CLAMP BAR	12064	11010	1
6	DISCHARGE NIPPLE	T64	15070	1	47	CLAMP BAR SCREW	2536	24000	1
7	HEX HD CAPSCREW	B1008	15991	4	48	INSTRUCTION DECAL	2613DK	-----	1
8	LOCKWASHER	J10	15991	4	49	MACHINE BOLT	A1012	15991	2
9	DISCHARGE FLANGE	271	10010	1	50	BACK COVER ASSY	42111-929	-----	1
10	DISCHARGE STICKER	6588BJ	-----	1	51	-BACK COVER PLATE	NOT AVAILABLE		1
11 *	DISCH FLANGE GASKET	1674G	18000	1	52	-WARNING PLATE	2613EV	13990	1
12	NAME PLATE	38818-023	13990	1	53	-DRIVE SCREW	BM#04-03	15990	4
13	DRIVE SCREW	BM#04-03	15990	4	54	-PIPE PLUG	P04	15079	1
14	GREASE CUP	S1509	-----	1	55 *	BACK COVER GASKET	2527G	19090	1
15	LUBE STICKER	6588BD	-----	1	56	STUD	C1010	15991	6
16	PIPE ELBOW	AG04	11999	1	57	HEX NUT	D10	15991	6
17	HEAVY PIPE NIPPLE	THA0408	15079	1	58 *	CHECK VALVE ASSY	46411-062	-----	1
18	AIR VENT	S1703	-----	1	59	SUCTION STICKER	6588AG	-----	1
19 *	INBOARD BALL BEARING	23251-209	-----	1	60	SUCTION FLANGE	12065	10010	1
20	INTERMEDIATE	38263-617	10010	1	61	PIPE PLUG	P04	15079	1
21 *	BEARING CAP GASKET	6404G	18000	2	62	STUD	C1011	15991	2
22	BEARING CAP	38324-408	10010	1	63	HEX NUT	D10	15991	2
23	HEX HD CAPSCREW	B0604	15991	4	64	CHECK VALVE PIN	11557	17010	1
24	LOCKWASHER	J06	15991	4	65 *	SUCT FLANGE GASKET	11389G	19370	1
25 *	OIL SEAL	25258-575	-----	1	66	PIPE PLUG	P04	15079	1
26 *	SHAFT KEY	N0607	15990	1	67	MACHINE BOLT	A1014	15991	2
27 *	IMPELLER SHAFT	38514-809	15010	1	68	FILL COVER PLATE ASSY	42111-344	-----	1
28 *	BEARING SHIM SET	48261-037	-----	1	69 *	-FILL COVER GASKET	50G	19210	1
29	INTERMEDIATE GUARD	42381-038	24150	2	70	-FILL COVER	NOT AVAILABLE		1
30 *	OUTBOARD BALL BRG	23251-209	-----	1	71	-WARNING PLATE	38816-097	13990	1
31	PIPE PLUG	P12	15079	1	72	-DRIVE SCREW	BM#04-03	15990	1
32	SIGHT GAUGE	S1471	-----	1	73	CLAMP BAR SCREW	31912-009	15000	1
33	PIPE PLUG	P06	15079	1	74	CLAMP BAR	38111-004	11010	1
34 *	OIL SEAL	25258-575	-----	1	75 *	SEAL LINER	2205	14080	REF
35	SEAL PLATE ASSY	6567A	10010	1	76 *	SEAL WASHER	37H	15990	1
36	HEX HD CAPSCREW	B0604	15991	4	77 *	IMP ADJ SHIM SET	37J	17090	1
37	LOCKWASHER	J06	15991	4		NOT SHOWN:			
38	STUD	C0606	15991	8		STRAINER	2690C	24000	1
39	HEX NUT	D06	15991	8		WARNING DECAL	38816-096	-----	1
40 *	CASING GASKET SET	2474G	18000	1		LUBE DECAL	38816-079	-----	1
41 *	SEAL PLATE GASKET	6568	18000	1					

* INDICATES PARTS RECOMMENDED FOR STOCK

SECTION DRAWING

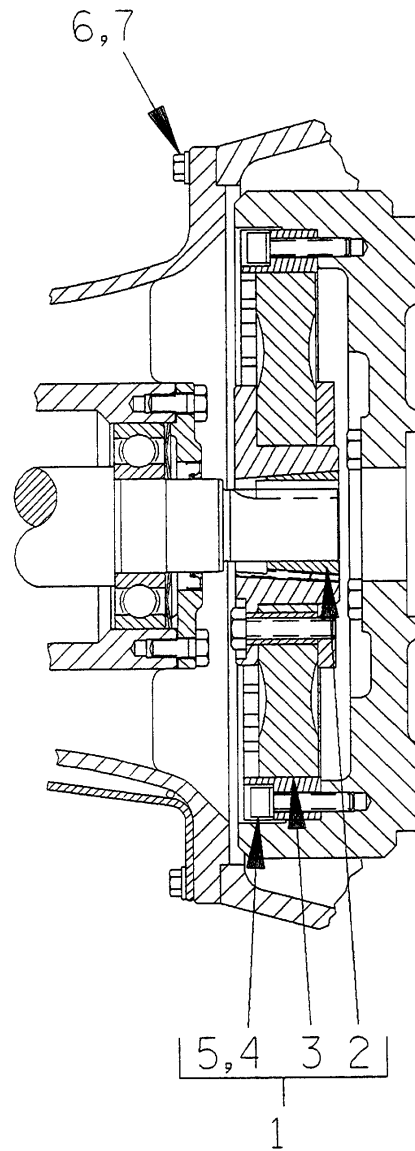

Figure 3. 14C2--(SAE 4/10) Drive Assembly

PARTS LIST

ITEM NO.	PART NAME	PART NUMBER	MAT'L CODE	QTY
1	COUPLING KIT	48112-001	----	1
2	-BUSHING	24131-345	----	1
3	-COUPLING ASSEMBLY	44165-011	----	1
4	-LOCKWASHER	21171-536	----	8
5	-SOCKET HD CAPSCREW	22644-220	----	8
6	HEX HD CAPSCREW	22645-164	----	12
7	LOCKWASHER	21171-511	----	12

PUMP AND SEAL DISASSEMBLY AND REASSEMBLY

Review all SAFETY information in Section A.

Follow the instructions on all tags, label and decals attached to the pump.

This pump requires little service due to its rugged, minimum-maintenance design. However, if it becomes necessary to inspect or replace the wearing parts, follow these instructions which are keyed to the sectional views (see Figures 1, 2 and 3) and the accompanying parts lists.

Most service functions, such as wear plate, impeller, and seal replacement, may be performed by draining the pump and removing the back cover assembly. However, the following instructions assume complete disassembly is required.

Before attempting to service the pump, switch off the engine ignition and remove the key, or take other precautions to ensure that it will remain inoperative. Close all valves in the suction and discharge lines.

For engine disassembly and repair, consult the literature supplied with the engine, or contact your local Deutz engine representative.

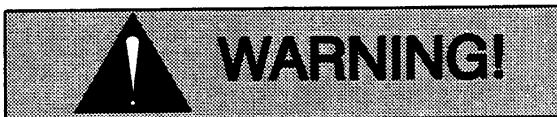

Before attempting to open or service the pump:

1. Familiarize yourself with this manual.
2. Switch off the engine ignition and disconnect the positive battery cable. Take other precautions to ensure that the pump will remain inoperative.
3. Allow the pump to completely cool if overheated.
4. Check the temperature before opening any covers, plates, or plugs.
5. Close the suction and discharge valves.

6. Vent the pump slowly and cautiously.

7. Drain the pump.

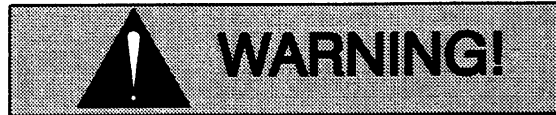

Use lifting and moving equipment in good repair and with adequate capacity to prevent injuries to personnel or damage to equipment. Suction and discharge hoses and piping must be removed from the pump before lifting.

Back Cover Removal

(Figure 2)

Before attempting to service the pump, remove the pump casing drain plug (43) and drain the pump. Clean and reinstall the drain plug. The wear plate (42) and check valve (58) are easily accessible and may be serviced by removing the back cover assembly (50).

Remove the cover clamp screw (47) and clamp bar (46) securing the back cover. Pull the back cover and assembled wear plate from the pump casing. Inspect the back cover gasket (55) and replace it if damaged or worn.

Inspect the wear plate and replace it if badly scored and worn. To remove the wear plate, disengage the hardware (44 and 45).

Suction Check Valve Removal

(Figure 2)

If the check valve assembly (58) is to be serviced, reach through the back cover opening and hold the assembly in place while removing the check valve pin (64). Slide the assembly from the suction flange (60) and remove it from the pump.

NOTE

Further disassembly of the check valve is not required since it must be replaced as a complete unit. Individual parts are not sold separately.

The check valve assembly may also be serviced by removing the suction flange (60). To remove the

flange, disengage the nuts (57 and 63) and pull the flange and assembled check valve from the suction port. Remove the check valve pin, and pull the check valve assembly out of the seat.

Replace the suction flange gasket (65) as required.

Pump Casing Removal

(Figure 1)

To service the impeller or seal assembly, disconnect the suction and discharge piping. Remove the hardware (47, 48, 49 and 50) securing the pump casing (1) to the base (46).

(Figure 2)

Remove the nuts (39) securing the pump casing to the intermediate (20). Install a standard 5/8-11 UNC lifting eye in the tapped hole in the top of the pump casing. **Be sure** to screw the eye into the casing until fully engaged. Use a hoist and sling of suitable capacity to separate the casing from the seal plate and intermediate.

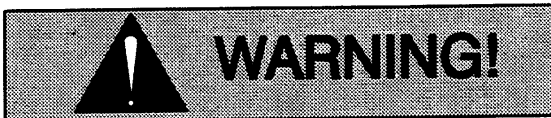

Do not attempt to lift the complete pump unit using the lifting eye. It is designed to facilitate removal or installation of individual components only. Additional weight may result in damage to the pump or failure of the eye bolt.

Remove the pump casing gaskets (40). Remove any leveling shims used under the casing mounting feet. Tie and tag the gaskets and shims, or measure and record their thickness for ease of reassembly.

Impeller Removal

(Figure 2)

Turn the cross arm on the automatic lubricating grease cup (14) clockwise until it rests against the cover (see Figure 5). This will prevent the grease from escaping when the impeller is removed.

To remove the impeller (2), tap the vanes in counterclockwise direction (when facing the impeller) with a block of wood or soft-faced mallet. **Be careful** not to damage the impeller. When the impeller breaks loose, unscrew it from the shaft. Use caution when removing the impeller; tension on the shaft seal spring will be released as the impeller is unscrewed. Inspect the impeller and replace if cracked or badly worn.

Slide the impeller adjusting shims (77) off the impeller shaft (27). Tie and tag the shims, or measure and record their thickness for ease of reassembly.

Seal Removal and Disassembly

(Figure 2)

To remove the seal assembly (3), remove the grease cup and piping (14, 16 and 17) from the seal plate (35). Remove the hardware (36 and 37), and slide the seal plate and seal parts off the shaft as a single unit. **Be careful** not to drop or damage any seal parts. Remove the seal plate gasket (41).

Carefully remove the stationary and rotating seal elements, packing rings, seal spring, and shaft sleeve from the seal plate. Remove the seal spacer washer (76) from the shaft.

NOTE

The seal assembly may be removed without completely disassembling the pump by removing the impeller through the back cover opening and using a pair of stiff wires with hooked ends to pull the seal parts out of the seal plate.

Inspect the seal liner (75) for wear or grooves which could cause leakage or damage to the seal packing rings. The seal liner is a press fit in the seal plate, and does not normally require replacement. If replacement is necessary, see **Seal Reassembly And Installation**.

If no further disassembly is required, refer to **Seal Reassembly And Installation**.

Separating Intermediate And Drive Assembly From Engine

(Figure 3)

If it is necessary to separate the intermediate and drive assemblies from the engine, support the in-

intermediate using a hoist and sling, and remove the hardware (6 and 7) securing the intermediate to the engine bellhousing. Remove the intermediate guards (29, Figure 2), and separate the assemblies by pulling the intermediate straight away from the engine.

As the assemblies separate, the flexible portion of the coupling assembly (3) will remain on the shaft. To remove the coupling from the shaft, unscrew the two allen head setscrews from the bushing (2). Screw one of the setscrews into the puller hole on the circumference of the bushing. As the coupling and bushing separate, remove the bushing, and slide the coupling off the shaft. Remove the shaft key (26, Figure 2).

It is not necessary to remove the outer ring of the coupling from the engine flywheel unless the coupling must be replaced. To remove the ring, disengage the hardware (4 and 5) securing it to the flywheel.

Shaft and Bearing Removal and Disassembly

(Figure 2)

When the pump is properly operated and maintained, the intermediate should not require disassembly. Disassemble the shaft and bearings **only** when there is evidence of wear or damage.

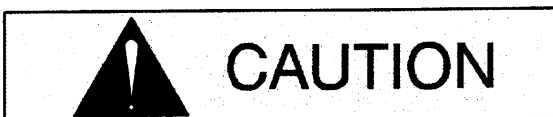

Shaft and bearing disassembly in the field is not recommended. These operations should be performed only in a properly equipped shop by qualified personnel.

Remove the intermediate drain plug (33) and drain the lubricant. Clean and reinstall the drain plug.

Disengage the hardware (23 and 24) and remove the bearing cap (22), gasket (21), oil seal (25) and bearing shim set (28). Tie and tag the shims, or measure and record their thickness for ease of reassembly.

Press the oil seal from the bearing cap.

Place a block of wood against the impeller end of the shaft (27), and tap the shaft and assembled bearings (19 and 30) from the intermediate. Press the inboard oil seal (34) from the intermediate.

After removing the shaft and bearings, clean and inspect the bearings **in place** as follows.



To prevent damage during removal from the shaft, it is recommended that bearings be cleaned and inspected **in place**. It is **strongly** recommended that the bearings be replaced **any** time the shaft and bearings are removed.

Clean the intermediate, shaft and all component parts (except the bearings) with a soft cloth soaked in cleaning solvent. Inspect the parts for wear or damage and replace as necessary.

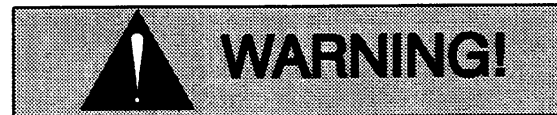

Most cleaning solvents are toxic and flammable. Use them only in a well-ventilated area free from excessive heat, sparks, and flame. Read and follow all precautions printed on solvent containers.

Clean the bearings thoroughly in **fresh** cleaning solvent. Dry the bearings with filtered compressed air and coat with light oil.

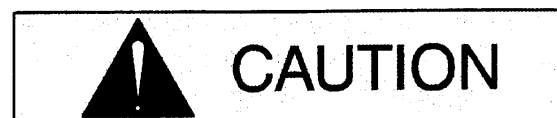

Bearings must be kept free of all dirt and foreign material. Failure to do so will greatly shorten bearing life. **Do not** spin dry bearings. This may scratch the balls or races and cause premature bearing failure.

Rotate the bearings by hand to check for roughness or binding and inspect the bearing balls. If ro-

tation is rough or the bearing balls are discolored, replace the bearings.

The bearing tolerances provide a tight press fit onto the shaft and a snug slip fit into the intermediate. Replace the bearings, shaft or intermediate if the proper bearing fit is not achieved.

If bearing replacement is required, use a bearing puller to remove the bearings from the shaft.

Shaft and Bearing Reassembly and Installation

(Figure 2)

Inspect the shaft for distortion, nicks or scratches, or for thread damage on the impeller end. Dress small nicks and burrs with a fine file or emery cloth. Replace the shaft if defective.

Position the inboard oil seal (34) in the intermediate housing bore with the lip positioned as shown in Figure 2. Press the oil seal into the housing until the face is **just flush** with the machined surface of the intermediate.

Clean and inspect the bearings as indicated in **Shaft And Bearing Removal And Disassembly**.



To prevent damage during removal from the shaft, it is recommended that bearings be cleaned and inspected **in place**. It is **strongly** recommended that the bearings be replaced **any** time the shaft and bearings are removed.

The bearings may be heated to ease installation. An induction heater, hot oil bath, electric oven, or hot plate may be used to heat the bearings. Bearings should **never** be heated with a direct flame or directly on a hot plate.

NOTE

*If a hot oil bath is used to heat the bearings, both the oil and the container must be **absolutely** clean. If the oil has been previously used, it must be **thoroughly** filtered.*

Heat the bearings to a uniform temperature **no higher than 250°F (120°C)**, and slide the bearings onto the shaft, one at a time, until they are fully seated. This should be done quickly, in one continuous motion, to prevent the bearings from cooling and sticking on the shaft.

NOTE

*The loading groove on both bearings (19 and 30) must be positioned **away** from the impeller end of the shaft.*

After the bearings have been installed and allowed to cool, check to ensure that they have not moved away from the shaft shoulders in shrinking. If movement has occurred, use a suitable sized sleeve and a press to reposition the bearings against the shaft shoulders.

If heating the bearings is not practical, use a suitable sized sleeve, and an arbor (or hydraulic) press to install the bearings on the shaft.



When installing the bearings onto the shaft, **never** press or hit against the outer race, balls, or ball cage. Press **only** on the inner race.

Slide the shaft and assembled bearings into the intermediate bore until the inboard bearing is fully seated against the bore shoulder. **Be careful** not to damage the lip of the oil seal (34) on the shaft threads.



When installing the shaft and bearings into the bearing bore, push against the outer race. **Never** hit the balls or ball cage.

Apply a light coating of oil to the lip of the outboard oil seal (25), and press it into the bearing cap (22) with the lip positioned as shown in Figure 2. The face of the oil seal should be **just flush** with the outer face of the bearing cap.

Install the same thickness of bearing adjusting shims (28) as previously removed, and secure the

bearing cap and gasket (21) to the intermediate with the hardware (23 and 24). Be careful not to damage the lip of the oil seal on the shaft keyway.

NOTE

Shaft endplay is to be .002 to .010 inch (0,05 to 0,25 mm). Add or remove bearing adjusting shims until the correct endplay is achieved.

Lubricate the bearings as indicated in **LUBRICATION** at the end of this section.

Securing Intermediate And Drive Assembly To Engine

(Figure 3)

Install the shaft key (26, Figure 2) in the shaft keyway. Position the flexible portion of the coupling assembly (3) on the shaft as shown in Figure 3.

NOTE

*The flexible portion of the coupling must be properly positioned on the shaft. The heads of the capscrews in the center of the coupling **must be positioned toward the pump end of the shaft.***

Align the keyway in the bushing (2) with the shaft key, and slide it onto the shaft until it is **just flush** with the end of the shaft. Rotate the flexible portion of the coupling until the tapped holes for the two setscrews align with those in the bushing, and install the setscrews.

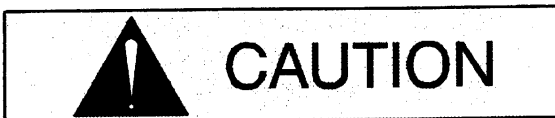

Make certain that the flexible portion of the coupling is mounted as shown in Figure 3. **This is critical.** If the coupling is not properly positioned on the shaft, the coupling parts may not fully engage, or a pre-load condition can cause premature bearing failure.

The end of the shaft must be **just flush** with the face of the bushing. This will allow the two portions of the coupling to fully engage when the intermediate is secured to the en-

gine bellhousing, without pre-loading the bearings.

With the flexible portion of the coupling and the bushing properly positioned on the shaft, tighten the two setscrews in an alternating sequence until the bushing and coupling are fully secured. Torque the setscrews to 14.6 ft. lbs. (175 in. lbs. or 2 m. kg.).

If the complete coupling assembly is being replaced, apply 'Loctite Retaining Compound No. 242' or equivalent to the threads of the hardware (4 and 5), and secure the outer ring of the coupling to the engine flywheel by torquing the hardware to 45 ft. lbs. (540 in. lbs. or 6,2 m. kg.).

Using a suitable lifting device, position the assembled coupling, intermediate, shaft and bearings so the flexible portion of the coupling seats inside the outer ring attached to the engine flywheel.

NOTE

*To ease installation, **lightly** lubricate the rubber portion of the coupling with a **non-petroleum based lubricant** such as vegetable oil or glycerin, or a silicon-based lubricant such as "WD40" or equivalent. **Do not** use petroleum-based lubricants, or any other substance which may soften or otherwise damage the rubber.*

Install the intermediate guards (29, Figure 2), and secure the intermediate to the engine bellhousing with the hardware (6 and 7).

Seal Reassembly and Installation

(Figures 2 and 4)

Clean the seal cavity and shaft with a cloth soaked in fresh cleaning solvent.

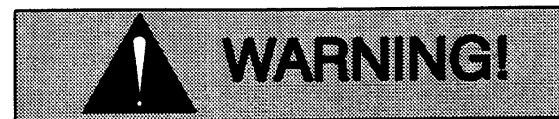

Most cleaning solvents are toxic and flammable. Use them only in a well-ventilated area free from excessive heat, sparks, and flame. Read and follow all precautions printed on solvent containers.

The seal is not normally reused because wear patterns on the finished faces cannot be realigned during reassembly. This could result in premature failure. If necessary to reuse an old seal in an emergency, **carefully** wash all metallic parts in **fresh** cleaning solvent and allow to dry thoroughly.

Handle the seal parts with extreme care to prevent damage. Be careful not to contaminate precision finished faces; even fingerprints on the faces can shorten seal life. If necessary, clean the faces with a non-oil based solvent and a clean, lint-free tissue. Wipe **lightly** in a concentric pattern to avoid scratching the faces.

Inspect the seal components for wear, scoring, grooves, and other damage that might cause leak-

age. Clean and polish the shaft sleeve, or replace it if there are nicks or cuts on either end. If any components are worn, replace the complete seal; **never mix old and new seal parts.**

If a replacement seal is being used, remove it from the container and inspect the precision finished faces to ensure that they are free of any foreign matter.

To ease installation of the seal, lubricate the packing rings and seal liner with water or a very small amount of oil, and apply a drop of light lubricating oil on the finished faces. Assemble the seal as follows, (see Figure 4).

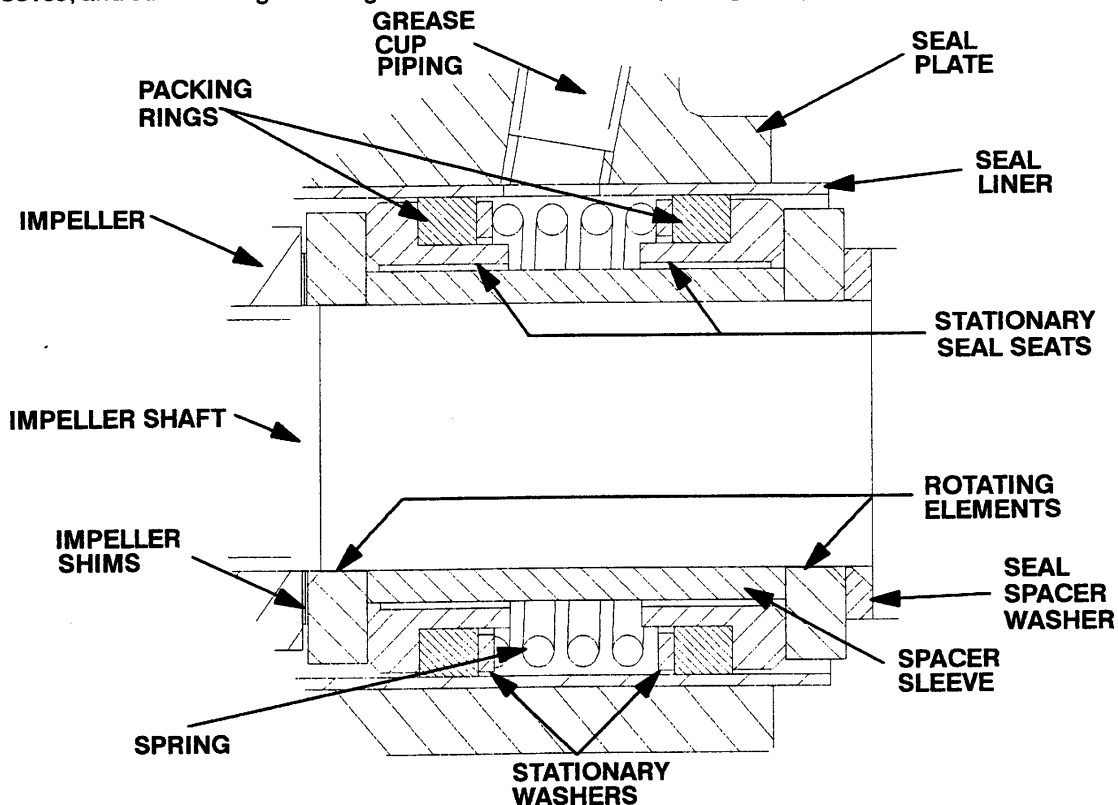
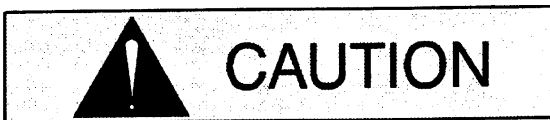

Figure 4. GS1250 Seal Assembly



This seal is not designed for operation at temperatures above 110°F (43°C). Do not use at higher operating temperatures.

Inspect the seal plate (35), seal liner (75), and the impeller shaft for burrs or sharp corners, and remove any that exist. Replace the seal liner if wear or grooves exist which could cause leakage or damage to the seal packing rings. To replace the seal liner, position the seal plate on the bed of an arbor (or hydraulic) press, and use a new sleeve to force the old one out. After the new liner is properly in-

stalled, a 1/4-inch (6,4 mm) diameter hole must be drilled through it to permit the flow of lubricant to the seal assembly. **Be careful** to center the drill in the threaded grease pipe hole and not damage the threads. Deburr the hole from the inside of the seal liner after drilling.

Slide the seal plate and gasket (40) onto the shaft until fully seated against the intermediate. Align the threaded seal lubricant hole with the intermediate opening, and secure the seal plate to the intermediate with the hardware (36 and 37).

Position the seal spacer washer (76) on the shaft with the chamfered side toward the shaft shoulder, and slide it onto the shaft until fully seated. Install the inboard rotating element with the chamfered side facing the spacer washer.

Subassemble the stationary seal seats, packing rings, stationary washers, and spring onto the lubricated shaft sleeve. Apply a drop of light oil on the precision finished faces of the stationary seats; **never use grease**. Slide the entire subassembly into the lubricated seal liner until it bottoms against the inboard rotating element.

Install the outboard rotating element with the chamfered side facing the impeller.

Reinstall the automatic grease cup and piping (14, 16 and 17).

Lubricate the seal as indicated in **LUBRICATION**, after the impeller has been installed.

Impeller Installation And Adjustment

(Figure 2)

Inspect the impeller, and replace it if cracked or badly worn.



The shaft and impeller threads **must** be completely clean before reinstalling the impeller. Even the slightest amount of dirt on the threads can cause the impeller to seize to the shaft, making future removal difficult

or impossible without damage to the impeller or shaft.

Install the same thickness of impeller adjusting shims (77) as previously removed, and screw the impeller onto the shaft until tight.

NOTE

*At the slightest sign of binding, **immediately** back the impeller off, and check the threads for dirt. **Do not** try to force the impeller onto the shaft.*

A clearance of .020 to .040 inch (0,5 to 1,0 mm) between the impeller and the seal plate is necessary for maximum pump efficiency. Measure this clearance, and add or remove impeller adjusting shims as required.

NOTE

If the pump has been completely disassembled, it is recommended that the wear plate (42) and back cover assembly (50) be reinstalled at this point. The back cover and wear plate must be in place to adjust the impeller face clearance.

Install the same thickness of pump casing gaskets (40) as previously removed. Secure the pump casing to the intermediate with the nuts (39). **Do not** fully tighten the nuts until the impeller face clearance has been set.

A clearance of .010 to .020 inch (0,25 to 0,50 mm) between the impeller and the wear plate is also recommended for maximum pump efficiency. This clearance must be set after installing the back cover, by adding or removing gaskets in the pump casing gasket set until the impeller scrapes against the wear plate when the shaft is turned. After the impeller scrapes, add approximately .010 inch (0,25 mm) of gaskets.

NOTE

An alternate method of adjusting this clearance is to reach through the discharge port with a feeler gauge and measure the gap. Add or subtract pump casing gaskets accordingly.

If a lifting eye was used to move the pump casing, **be sure** to remove the lifting eye from the pump casing.

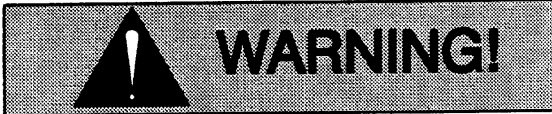

Do not attempt to lift the complete pump unit using the lifting eye. It is designed to facilitate removal or installation of individual components only. Additional weight may result in damage to the pump or failure of the eye bolt.

Suction Check Valve Installation

(Figure 2)

Inspect the check valve assembly (58) and replace it if badly worn.

NOTE

The check valve assembly must be replaced as a complete unit. Individual parts are not sold separately.

Reach through the back cover opening with the assembled check valve, and position the check valve adaptor in the mounting slot in the suction flange. Align the adaptor with the flange hole and secure the assembly with the check valve pin (64).

NOTE

If the suction flange was removed, replace the gasket (65), and apply 'Permatex Aviation No. 3 Form-A-Gasket' or equivalent compound to the mating surfaces.

Back Cover Installation

(Figure 2)

If the wear plate (42) was removed for replacement, carefully center it on the back cover and secure it with the hardware (44 and 45). The wear plate **must** be concentric to prevent binding when the back cover is installed.

Clean any scale or debris from the contacting surfaces in the pump casing that might interfere or prevent a good seal with the back cover. Replace the back cover gasket (55), and slide the back

cover assembly into the pump casing. Be sure the wear plate does not bind against the impeller.

NOTE

To ease future disassembly, apply a film of grease or 'Never-Seez' on the back cover shoulder, or any surface which contacts the pump casing. This action will reduce rust and scale build-up.

Secure the back cover assembly by tightening the cover clamp screw (47) against the clamp bar (46). **Do not** over-tighten the clamp screw; it should be just tight enough to ensure a good seal at the back cover shoulder.

Final Pump Assembly

(Figure 1)

Install any leveling shims used under the pump casing mounting feet and secure the casing (1) to the base (46) with the hardware (47, 48, 49 and 50). **Be sure** the pump is secured to the base and engine.

Install the suction and discharge lines, and open all valves. Make certain that all piping connections are tight, properly supported and secure.

Be sure the pump end and engine have been properly lubricated, see **LUBRICATION**.

Remove the fill cover assembly (68, Figure 2) and fill the pump casing with clean liquid. Reinstall the fill cover plate and tighten it.

Refer to **OPERATION**, Section C, and start the pump.

LUBRICATION

Seal Assembly

(Figure 2)

Fill the grease cup (14) through the grease fitting with No. 2 lithium base grease until grease escapes from the relief hole. Turn the grease cup arm counterclockwise until it is at the top of the stem; this will release the spring to apply grease to the seal (see Figure 5).

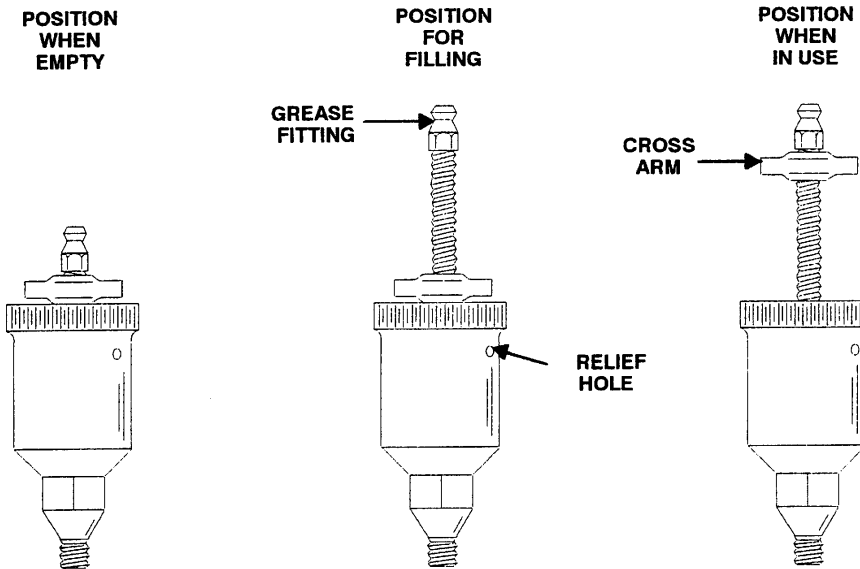
**NOTE:**

When installing a new grease cup, lubricate the cup as indicated on the installation tag furnished with the grease cup.

Figure 5. Automatic Lubricating Grease Cup

Bearings**(Figure 2)**

The intermediate was fully lubricated when shipped from the factory. Check the oil level regularly through the sight gauge (32), and maintain it at the middle of the gauge. When lubrication is required, add SAE No. 30 non-detergent oil through the hole for the air vent (18). **Do not** over-lubricate. Over-lubrication can cause the bearings to over-heat, resulting in premature bearing failure.

NOTE

The white reflector in the sight gauge must be positioned horizontally to provide proper drainage.

Under normal conditions, drain the intermediate once each year and refill with approximately 4 ounces (118 mL) of clean oil. Change the oil more frequently if the pump is operated continuously or

installed in an environment with rapid temperature change.



Monitor the condition of the bearing lubricant regularly for evidence of rust or moisture condensation. This is especially important in areas where variable hot and cold temperatures are common.

For cold weather operation, consult the factory or a lubricant supplier for the recommended grade of oil.

Engine

Consult the literature supplied with the engine, or contact your local Deutz engine representative.

**THE GORMAN-RUPP COMPANY AND
GORMAN-RUPP OF CANADA LIMITED
12 MONTH LIMITED WARRANTY**

EXTENT AND DURATION OF WARRANTY

Coverage: The Gorman-Rupp Company or Gorman-Rupp of Canada Limited (herein individually referred to as "GR") each individually warrant that its products and parts shall be free from defects in material and workmanship for twelve (12) months from the date of purchase by the original end user.

Exceptions: This Limited Warranty shall not apply to the following products and parts: engines, motors, trade accessories and other products, components or materials not manufactured by GR. With respect to submersible pumps, the pump and motor are an integral unit and are therefore warranted as a unit. However, with respect to the electrical components in submersible pumps, this warranty is valid **only** when electrical controls for the pump have been specified and/or provided by GR. Wear and tear on any product resulting from normal use is not covered by this Limited Warranty.

LIMITATIONS

GR'S SOLE AND EXCLUSIVE WARRANTY WITH RESPECT TO ITS PRODUCTS AND PARTS IS THIS LIMITED WARRANTY. THIS LIMITED WARRANTY IS IN LIEU OF ALL OTHER EXPRESS AND/OR IMPLIED WARRANTIES, INCLUDING IMPLIED WARRANTIES OF MERCHANTABILITY AND FITNESS FOR PARTICULAR PURPOSE.

EXCLUSIVE REMEDY AND DAMAGES

The sole and exclusive remedy for breach of this Limited Warranty by GR, and the entire extent of its liability for such breach or for damages arising and/or resulting from the use of the products and parts covered by this Limited Warranty shall be as follows:

1. **Repair or replacement:** If inspection shows that any GR product or part covered under this Limited Warranty is defective in materials or workmanship, GR shall repair or replace the defective product or part at its option, without charge. You must have properly installed, maintained and used the product or part claimed to be defective in accordance with the maintenance schedule and/or manual which comes with the product. *No allowance will be made for labor, transportation or other charges incurred by you in connection with such repair or replacement.*
2. **To obtain the above remedy:**
 - a) Immediately notify GR at the address below of the claimed defect in materials or workmanship and provide the serial number or date code of the product and/or part and provide a copy of the invoice or bill of sale referencing the product and/or part by no later than the expiration date of the Limited Warranty period.
 - b) GR will advise whether inspection of the product and/or part will be necessary and whether and how repair or replacement will be effected. If inspection by GR is necessary, the product or part must be sent freight prepaid to GR at the address stated below. Return shipment of the repaired product or part will be F.O.B. the address stated below.
3. **Damages:** GR's liability for damages for breach of this Limited Warranty shall not exceed the amount of the purchase price of the product or part in respect to which damages are claimed. **IN NO EVENT SHALL GR BE LIABLE FOR INCIDENTAL, CONSEQUENTIAL OR SPECIAL DAMAGES FOR BREACH OF THIS LIMITED WARRANTY OTHER THAN AS STATED HEREIN.**

Some states do not allow the exclusion or limitation of incidental or consequential damages. Accordingly, the above may not apply to you. This Limited Warranty gives you specific legal rights, and you may also have other rights which vary from state to state and province to province.

THE GORMAN-RUPP COMPANY
P.O. BOX 1217
MANSFIELD, OH 44901-1217
Phone: (419) 755-1011

GORMAN-RUPP OF CANADA LIMITED
70 Burwell Road
St. Thomas, Ontario N5P 3R7
Phone: (519) 631-2870