INSTALLATION, OPERATION, AND MAINTENANCE MANUAL

WITH PARTS LIST



10 SERIES PUMPS

MODEL
16A2-F3L

THE GORMAN-RUPP COMPANY • MANSFIELD, OHIO

GORMAN-RUPP OF CANADA LIMITED • ST. THOMAS, ONTARIO, CANADA Printed in U.S.A.

©Copyright by the Gorman-Rupp Company

TABLE OF CONTENTS

INTRODUCTION	PAGE I – 1
WARNINGS – SECTION A	PAGE A – 1
INSTALLATION – SECTION B	PAGE B – 1
Pump Dimensions	PAGE B – 1
PREINSTALLATION INSPECTION	PAGE B – 2
Battery Specifications And Installation	PAGE B – 2
POSITIONING PUMP	PAGE B – 2
Lifting	PAGE B – 2
Mounting	PAGE B – 2
SUCTION AND DISCHARGE PIPING	PAGE B – 3
Materials	PAGE B – 3
Line Configuration	PAGE B – 3
Connections to Pump	PAGE B – 3
Gauges	PAGE B – 3
SUCTION LINES	PAGE B – 3
Fittings	PAGE B – 3
Strainers	PAGE B – 3
Sealing	PAGE B – 4
Suction Lines In Sumps	PAGE B – 4
Suction Line Positioning	PAGE B – 4
DISCHARGE LINES	PAGE B – 5
Siphoning	PAGE B – 5
Valves	PAGE B – 5
Bypass Lines	PAGE B – 5
ALIGNMENT	PAGE B – 5
OPERATION – SECTION C	PAGE C – 1
PRIMING	PAGE C – 1
STARTING	PAGE C – 2
OPERATION	PAGE C – 2
Lines With a Bypass	PAGE C – 2
Lines Without a Bypass	PAGE C – 2
Leakage	PAGE C – 2
Liquid Temperature And Overheating	PAGE C – 2
Strainer Check	PAGE C – 2
Pump Vacuum Check	PAGE C – 2
STOPPING	PAGE C – 3
Cold Weather Preservation	PAGE C – 3
BEARING TEMPERATURE CHECK	PAGE C – 3
TROUBLESHOOTING – SECTION D	PAGE D – 1
PUMP MAINTENANCE AND REPAIR – SECTION E	PAGE E – 1
PERFORMANCE CURVE	PAGE E – 1

TABLE OF CONTENTS
(continued)

PARTS LISTS	
Pump Model	PAGE E - 3
Pump End Assy	PAGE E - 5
Drive Assembly	PAGE E - 7
PUMP AND SEAL DISASSEMBLY AND REASSEMBLY	PAGE E - 8
Back Cover Removal	PAGE E - 8
Suction Check Valve Removal	PAGE E - 8
Pump Casing Removal	PAGE E - 9
Impeller Removal	PAGE E - 9
Seal Removal and Disassembly	PAGE E - 9
Separating Intermediate And Drive Assembly From engine	PAGE E - 9
Shaft and Bearing Removal and Disassembly	PAGE E - 10
Shaft and Bearing Reassembly and Installation	PAGE E - 11
Securing Intermediate And Drive Assembly To Engine	PAGE E - 11
Seal Reassembly and Installation	PAGE E - 12
Impeller Installation And Adjustment	PAGE E - 14
Suction Check Valve Installation	PAGE E - 14
Back Cover Installation	PAGE E - 14
Final Pump Assembly	PAGE E - 15
LUBRICATION	PAGE E - 15
Seal Assembly	PAGE E - 15
Bearings	PAGE E - 15
Engine	PAGE E - 16

INTRODUCTION

This Installation, Operation, and Maintenance manual is designed to help you achieve the best performance and longest life from your Gorman-Rupp pump.

This pump is a 10 Series, semi-open impeller, self-priming centrifugal model with a suction check

valve. The pump is powered by a three cylinder Deutz diesel engine, model F3L-912D. The pump is designed for handling dirty water containing specified entrained solids. The basic material of construction for wetted parts is gray iron, with ductile iron impeller and steel wearing parts.

If there are any questions regarding the pump or its application which are not covered in this manual or in other literature accompanying this unit, please contact your Gorman-Rupp distributor, or write:

The Gorman-Rupp Company
P.O. Box 1217
Mansfield, Ohio 44901-1217

or

Gorman-Rupp of Canada Limited
70 Burwell Road
St. Thomas, Ontario N5P 3R7

For information or technical assistance on the engine, contact the engine manufacturer's local dealer or representative.

The following are used to alert maintenance personnel to procedures which require special attention, to those which could damage equipment, and to those which could be dangerous to personnel:

NOTE

Instructions to aid in installation, operation, and maintenance or which clarify a procedure.

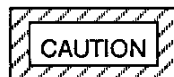

INSTRUCTIONS WHICH MUST BE FOLLOWED TO AVOID CAUSING DAMAGE TO THE PRODUCT OR OTHER EQUIPMENT INCIDENTAL TO THE INSTALLATION. THESE INSTRUCTIONS DESCRIBE THE REQUIREMENTS AND THE POSSIBLE DAMAGE WHICH COULD RESULT FROM FAILURE TO FOLLOW THE PROCEDURES.

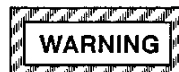

THESE INSTRUCTIONS MUST BE FOLLOWED TO AVOID CAUSING INJURY OR DEATH TO PERSONNEL, AND DESCRIBE THE PROCEDURE REQUIRED AND THE INJURY WHICH COULD RESULT FROM FAILURE TO FOLLOW THE PROCEDURE.

WARNINGS - SECTION A

THESE WARNINGS APPLY TO 10 SERIES ENGINE DRIVEN PUMPS. REFER TO THE MANUAL ACCOMPANYING THE ENGINE BEFORE ATTEMPTING TO BEGIN OPERATION.



BEFORE ATTEMPTING TO OPEN OR SERVICE THE PUMP:

1. FAMILIARIZE YOURSELF WITH THIS MANUAL.
2. SWITCH OFF THE ENGINE IGNITION AND REMOVE THE KEY TO ENSURE THAT THE PUMP WILL REMAIN INOPERATIVE.
3. ALLOW THE PUMP TO COOL IF OVERHEATED.
4. CHECK THE TEMPERATURE BEFORE OPENING ANY COVERS, PLATES, OR PLUGS.
5. CLOSE THE SUCTION AND DISCHARGE VALVES.
6. VENT THE PUMP SLOWLY AND CAUTIOUSLY.
7. DRAIN THE PUMP.

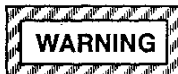

THIS PUMP IS DESIGNED TO HANDLE DIRTY WATER CONTAINING SPECIFIED ENTRAINED SOLIDS. DO NOT ATTEMPT TO PUMP VOLATILE, CORROSIVE, OR FLAMMABLE MATERIALS, OR ANY LIQUIDS WHICH MAY DAMAGE THE PUMP OR ENDANGER PERSONNEL AS A RESULT OF PUMP FAILURE.



USE LIFTING AND MOVING EQUIPMENT IN GOOD REPAIR AND WITH ADEQUATE CAPACITY TO PREVENT INJURIES TO PERSONNEL OR DAMAGE TO EQUIPMENT. THE BAIL IS INTENDED FOR USE IN LIFTING THE PUMP AS-

SEMBLY ONLY. SUCTION AND DISCHARGE HOSES AND PIPING MUST BE REMOVED FROM THE PUMP BEFORE LIFTING.



AFTER THE PUMP HAS BEEN POSITIONED, MAKE CERTAIN THAT THE PUMP AND ALL PIPING OR HOSE CONNECTIONS ARE TIGHT, PROPERLY SUPPORTED AND SECURE BEFORE OPERATION.

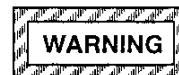

DO NOT OPERATE THE PUMP AGAINST A CLOSED DISCHARGE VALVE FOR LONG PERIODS OF TIME. IF OPERATED AGAINST A CLOSED DISCHARGE VALVE, PUMP COMPONENTS WILL DETERIORATE, AND THE LIQUID COULD COME TO A BOIL, BUILD PRESSURE, AND CAUSE THE PUMP CASING TO RUPTURE OR EXPLODE.

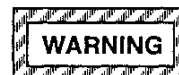

DO NOT REMOVE PLATES, COVERS, GAUGES, PIPE PLUGS, OR FITTINGS FROM AN OVERHEATED PUMP. VAPOR PRESSURE WITHIN THE PUMP CAN CAUSE PARTS BEING DISENGAGED TO BE EJECTED WITH GREAT FORCE. ALLOW THE PUMP TO COOL BEFORE SERVICING.



DO NOT OPERATE AN INTERNAL COMBUSTION ENGINE IN AN EXPLOSIVE ATMOSPHERE. WHEN OPERATING INTERNAL COMBUSTION ENGINES IN AN ENCLOSED AREA, MAKE CERTAIN THAT EXHAUST FUMES ARE PIPED TO THE OUTSIDE. THESE FUMES CONTAIN CAR-

BON MONOXIDE, A DEADLY GAS THAT IS COLORLESS, TASTELESS, AND ODORLESS.



FUEL USED BY INTERNAL COMBUSTION ENGINES PRESENTS AN EXTREME EXPLOSION AND FIRE HAZARD. MAKE CERTAIN THAT ALL FUEL LINES ARE SECURELY CONNECTED AND FREE OF LEAKS. NEVER REFUEL A HOT OR RUNNING ENGINE. AVOID OVERFILLING THE

FUEL TANK. ALWAYS USE THE CORRECT TYPE OF FUEL.



NEVER TAMPER WITH THE GOVERNOR TO GAIN MORE POWER. THE GOVERNOR ESTABLISHES SAFE OPERATING LIMITS THAT SHOULD NOT BE EXCEEDED. THE MAXIMUM CONTINUOUS OPERATING SPEED FOR THIS PUMP IS 1800 RPM.

INSTALLATION - SECTION B

Review all WARNINGS in Section A.

Since pump installations are seldom identical, this section offers only general recommendations and practices required to inspect, position, and arrange the pump and piping.

Most of the information pertains to a standard **static lift application where the pump is positioned above the free level of liquid to be pumped.**

If installed in a **flooded suction application** where the liquid is supplied to the pump under pressure, some of the information such as mounting, line configuration, and priming must be tailored to the spe-

cific application. Since the pressure supplied to the pump is critical to performance and safety, **be sure** to limit the incoming pressure to **50%** of the maximum permissible operating pressure as shown on the pump performance curve.

For further assistance, contact your Gorman-Rupp distributor or the Gorman-Rupp Company.

Pump Dimensions

See Figure 1 for the approximate physical dimensions of this pump and engine.

OUTLINE DRAWING

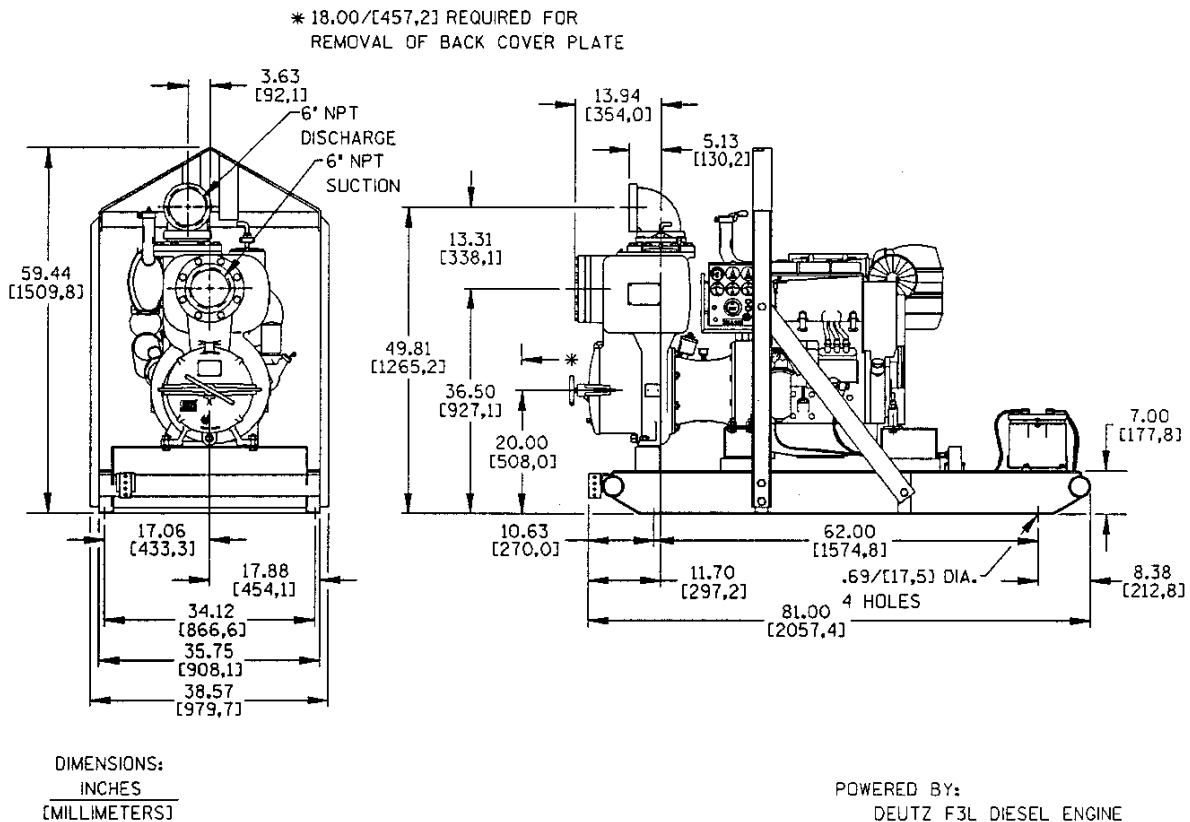

Figure 1. Pump Model 16A2-F3L

PREINSTALLATION INSPECTION

The pump assembly was inspected and tested before shipment from the factory. Before installation, inspect the pump for damage which may have occurred during shipment. Check as follows:

- a. Inspect the pump for cracks, dents, damaged threads, and other obvious damage.
- b. Check for and tighten loose attaching hardware. Since gaskets tend to shrink after drying, check for loose hardware at mating surfaces.
- c. Carefully read all warnings and cautions contained in this manual or affixed to the pump, and perform all duties indicated.
- d. Check levels and lubricate as necessary. Refer to **LUBRICATION** in the **MAINTENANCE AND REPAIR** section of this manual and perform duties as instructed.
- e. If the pump and engine have been stored for more than 12 months, some of the components or lubricants may have exceeded their maximum shelf life. These **must be inspected or replaced** to ensure maximum pump service.

If the maximum shelf life has been exceeded, or if anything appears to be abnormal, contact your Gorman-Rupp distributor or the factory to determine the repair or updating policy. **Do not** put the pump into service until appropriate action has been taken.

Battery Specifications And Installation

Unless otherwise specified on the pump order, the engine battery was **not** included with the unit. Refer to the following specifications when selecting a battery.

Voltage	Cold Crank Amps @ 0° F	Reserve Capacity @ 80° F (Minutes)	Amp/ Hr. Rating	Approx. Overall Dims. (Inches)
12 Volts	960-975	365	175	20.5L x 8.75W x 9.75H

Table 1. Battery Specifications

Refer to the information accompanying the battery and/or electrolyte solution for activation and charging instructions.

Before installing the battery, clean the positive and negative cable connectors, and the battery terminals. Secure the battery by tightening the holddown brackets. The terminals and clamps may be coated with petroleum jelly to retard corrosion. Connect and tighten the positive cable first, then the negative cable.

POSITIONING PUMP

Lifting

Use lifting equipment with a capacity of at least **9,500 pounds (4309 kg)**. This pump weighs approximately **1,900 pounds (861,8 kg)**, not including the weight of accessories and customer installed options and accessories. Customer installed equipment such as suction and discharge piping **must** be removed before attempting to lift.

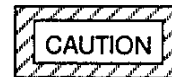

THE PUMP ASSEMBLY CAN BE SERIOUSLY DAMAGED IF THE CABLES OR CHAINS USED TO LIFT AND MOVE THE UNIT ARE IMPROPERLY WRAPPED AROUND THE PUMP.

Mounting

Locate the pump in an accessible place as close as practical to the liquid being pumped. Level mounting is essential for proper operation.

The pump may have to be supported or shimmed to provide for level operation or to eliminate vibration.

To ensure sufficient lubrication and fuel supply to the engine, **do not** position the pump and engine more than 15° off horizontal for continuous operation. The pump and engine may be positioned up to 30° off horizontal for **intermittent operation only**; however, the engine manufacturer should be consulted for continuous operation at angles greater than 15°.

Clearance

When positioning the pump, allow a minimum clearance of **18 inches (457 mm)** in front of the back

cover to permit removal of the cover and easy access to the pump interior.

SUCTION AND DISCHARGE PIPING

Pump performance is adversely effected by increased suction lift, discharge elevation, and friction losses. See the performance curve and operating range shown on Page E-1 to be sure your overall application allows pump to operate within the safe operation range.

Materials

Either pipe or hose may be used for suction and discharge lines; however, the materials must be compatible with the liquid being pumped. If hose is used in suction lines, it must be the rigid-wall, reinforced type to prevent collapse under suction. Using piping couplings in suction lines is not recommended.

Line Configuration

Keep suction and discharge lines as straight as possible to minimize friction losses. Make minimum use of elbows and fittings, which substantially increase friction loss. If elbows are necessary, use the long-radius type to minimize friction loss.

Connections to Pump

Before tightening a connecting flange, align it exactly with the pump port. Never pull a pipe line into place by tightening the flange bolts and/or couplings.

Lines near the pump must be independently supported to avoid strain on the pump which could cause excessive vibration, decreased bearing life, and increased shaft and seal wear. If hose-type lines are used, they should have adequate support to secure them when filled with liquid and under pressure.

Gauges

Most pumps are drilled and tapped for installing discharge pressure and vacuum suction gauges. If these gauges are desired for pumps that are not tapped, drill and tap the suction and discharge lines not less than 18 inches (457,2 mm) from the suction and discharge ports and install the lines. Installation closer to the pump may result in erratic readings.

SUCTION LINES

To avoid air pockets which could affect pump priming, the suction line must be as short and direct as possible. When operation involves a suction lift, the line must always slope upward to the pump from the source of the liquid being pumped; if the line slopes down to the pump at any point along the suction run, air pockets will be created.

Fittings

Suction lines should be the same size as the pump inlet. If reducers are used in suction lines, they should be the eccentric type, and should be installed with the flat part of the reducers uppermost to avoid creating air pockets. Valves are not normally used in suction lines, but if a valve is used, install it with the stem horizontal to avoid air pockets.

Strainers

If a strainer is furnished with the pump, be certain to use it; any spherical solids which pass through a strainer furnished with the pump will also pass through the pump itself.

If a strainer is not furnished with the pump, but is installed by the pump user, make certain that the total area of the openings in the strainer is at least three or four times the cross section of the suction line, and that the openings will not permit passage of solids larger than the solids handling capability of the pump.

This pump is designed to handle up to 2 1/2 inch (63,5 mm) diameter spherical solids.

Sealing

Since even a slight leak will affect priming, head, and capacity, especially when operating with a high

suction lift, all connections in the suction line should be sealed with pipe dope to ensure an airtight seal. Follow the sealant manufacturer's recommendations when selecting and applying the pipe dope. The pipe dope should be compatible with the liquid being pumped.

If two suction lines are installed in a single sump, the flow paths may interact, reducing the efficiency of one or both pumps. To avoid this, position the suction inlets so that they are separated by a distance equal to at least 3 times the diameter of the suction pipe.

Suction Lines In Sumps

If a single suction line is installed in a sump, it should be positioned away from the wall of the sump at a distance equal to 1 1/2 times the diameter of the suction line.

If there is a liquid flow from an open pipe into the sump, the flow should be kept away from the suction inlet because the inflow will carry air down into the sump, and air entering the suction line will reduce pump efficiency.

If it is necessary to position inflow close to the suction inlet, install a baffle between the inflow and the suction inlet at a distance 1 1/2 times the diameter of the suction pipe. The baffle will allow entrained air to escape from the liquid before it is drawn into the suction inlet.

Suction Line Positioning

The depth of submergence of the suction line is critical to efficient pump operation. Figure 2 shows recommended minimum submergence vs. velocity.

NOTE

The pipe submergence required may be reduced by installing a standard pipe increaser fitting at the end of the suction line. The larger opening size will reduce the inlet velocity. Calculate the required submergence using the following formula based on the increased opening size (area or diameter).

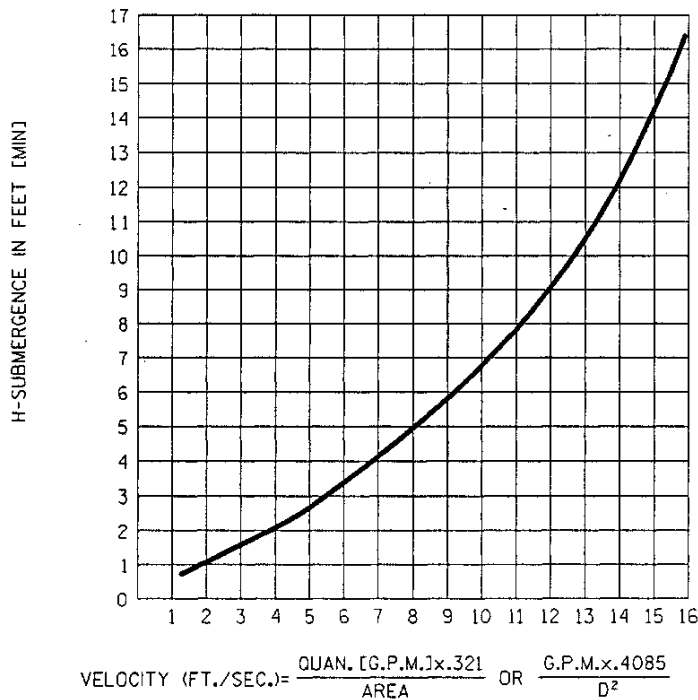

Figure 2. Recommended Minimum Suction Line Submergence vs. Velocity

DISCHARGE LINES

Siphoning

Do not terminate the discharge line at a level lower than that of the liquid being pumped unless a siphon breaker is used in the line. Otherwise, a siphoning action causing damage to the pump could result.

Valves

If a throttling valve is desired in the discharge line, use a valve as large as the largest pipe to minimize friction losses. Never install a throttling valve in a suction line.

With high discharge heads, it is recommended that a throttling valve and a system check valve be installed in the discharge line to protect the pump from excessive shock pressure and reverse rotation when it is stopped.



IF THE APPLICATION INVOLVES A HIGH DISCHARGE HEAD, GRADUALLY CLOSE THE DISCHARGE THROTTLING VALVE BEFORE STOPPING THE PUMP.

Bypass Lines

Self-priming pumps are not air compressors. During the priming cycle, air from the suction line must be vented to atmosphere on the discharge side. If the discharge line is open, this air will be vented through the discharge. However, if a check valve has been installed in the discharge line, the discharge side of the pump must be opened to atmospheric pressure through a bypass line installed between the pump discharge and the check valve. A self-priming centrifugal pump **will not prime** if there is sufficient static liquid head to hold the discharge check valve closed.

NOTE

The bypass line should be sized so that it does not affect pump discharge capacity; however, the by-

pass line should be at least 1 inch (25,4 mm) in diameter to minimize the chance of plugging.

In **low discharge head applications** (less than 30 feet or 9,1 meters), it is recommended that the bypass line be run back to the wet well, and located 6 inches below the water level or cut-off point of the low level pump. In some installations, this bypass line may be terminated with a six-to-eight foot length of 1 1/4 inch (31,8 mm) I.D. **smooth-bore** hose; air and liquid vented during the priming process will then agitate the hose and break up any solids, grease, or other substances likely to cause clogging.

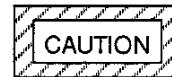

A BYPASS LINE THAT IS RETURNED TO A WET WELL MUST BE SECURED AGAINST BEING DRAWN INTO THE PUMP SUCTION INLET.

It is also recommended that pipe unions be installed at each 90° elbow in a bypass line to ease disassembly and maintenance.

In **high discharge head applications** (more than 30 feet or 9,1 meters), an excessive amount of liquid may be bypassed and forced back to the wet well under the full working pressure of the pump; this will reduce overall pumping efficiency. **Therefore, it is recommended that a Gorman-Rupp Automatic Air Release Valve be installed in the bypass line.**

If the installation involves a flooded suction such as in a below-ground lift station, a pipe union and manual shut-off valve may be installed in the bleed line to allow service of the valve without shutting down the station, and to eliminate the possibility of flooding. If a manual shut-off valve is installed **anywhere** in the air release piping, it **must** be a full-opening **ball type valve** to prevent plugging by solids.

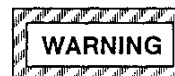

IF A MANUAL SHUT-OFF VALVE IS INSTALLED IN A BYPASS LINE, IT MUST NOT BE LEFT CLOSED DURING OPERATION. A CLOSED MANUAL SHUT-OFF VALVE MAY CAUSE A PUMP WHICH HAS LOST PRIME TO

CONTINUE TO OPERATE WITHOUT REACHING PRIME, CAUSING DANGEROUS OVERHEATING AND POSSIBLE EXPLOSIVE RUPTURE OF THE PUMP CASING. **PERSONNEL COULD BE SEVERELY INJURED.**

ALLOW AN OVER-HEATED PUMP TO COOL BEFORE SERVICING. DO NOT REMOVE PLATES, COVERS, GAUGES, OR FITTINGS FROM AN OVER-HEATED PUMP. LIQUID WITHIN THE PUMP CAN REACH BOILING TEMPERATURES, AND VAPOR PRESSURE WITHIN THE PUMP CAN CAUSE PARTS BEING DISENGAGED TO BE EJECTED WITH GREAT FORCE. AFTER THE PUMP COOLS, DRAIN THE LIQUID FROM THE PUMP BY REMOVING THE CASING DRAIN PLUG. USE CAUTION WHEN REMOVING THE PLUG TO PREVENT INJURY TO PERSONNEL FROM HOT LIQUID.

AUTOMATIC AIR RELEASE VALVE

When properly installed and correctly adjusted to the specific hydraulic operating conditions of the application, the Gorman-Rupp Automatic Air Release Valve will permit air to escape through the bypass line, and then close automatically when the pump is fully primed and pumping at full capacity.

Gorman-Rupp Automatic Air Release Valves are reliable, and require minimum maintenance. Consult your Gorman-Rupp distributor, or contact the Gorman-Rupp Company for selection of an Automatic Air Release Valve to fit your application.

Theory of Operation

Figures 3 and 4 show a cross-sectional view of the Automatic Air Release Valve, and a corresponding description of operation.

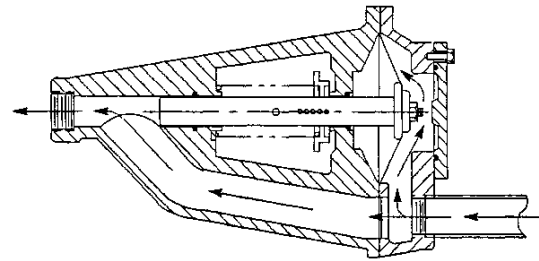

Figure 3. Valve in Open Position

During the priming cycle, air from the pump casing flows through the bypass line, and passes through the Air Release Valve to the wet well (Figure 3).

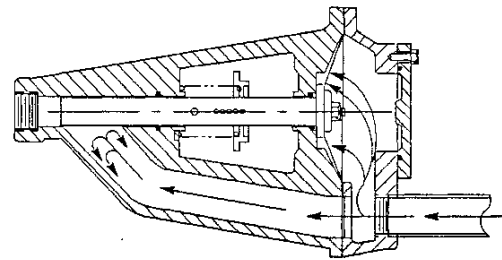

Figure 4. Valve in Closed Position

When the pump is fully primed, pressure resulting from flow against the valve diaphragm compresses the spring and closes the valve (Figure 4). The valve will remain closed, reducing the bypass of liquid to 1 to 5 gallons per minute, until the pump loses its prime or stops.

WARNING

SOME LEAKAGE (1 TO 5 GALLONS PER MINUTE) WILL OCCUR WHEN THE VALVE IS FULLY CLOSED. BE SURE THE BYPASS LINE IS DIRECTED BACK TO THE WET WELL OR TANK TO PREVENT HAZARDOUS SPILLS.

When the pump shuts down, the spring returns the diaphragm to its original position. Any solids that may have accumulated in the diaphragm chamber settle to the bottom and are flushed out during the next priming cycle.

NOTE

The valve will remain open if the pump does not reach its designed capacity or head. Valve closing pressure is dependent upon the discharge head of

the pump at full capacity. The range of the valve closing pressure is established by the tension rate of the spring as ordered from the factory. Valve closing pressure can be further adjusted to the exact system requirements by moving the spring retaining pin up or down the plunger rod to increase or decrease tension on the spring. Contact your Gorman-Rupp distributor or the Gorman-Rupp Company for information about an Automatic Air Release Valve for your specific application.

Air Release Valve Installation

The Automatic Air Release Valve must be independently mounted in a horizontal position and connected to the discharge line of the self-priming centrifugal pump (see Figure 5).

NOTE

If the Air Release Valve is to be installed on a **staged** pump application, contact the factory for specific installation instructions.

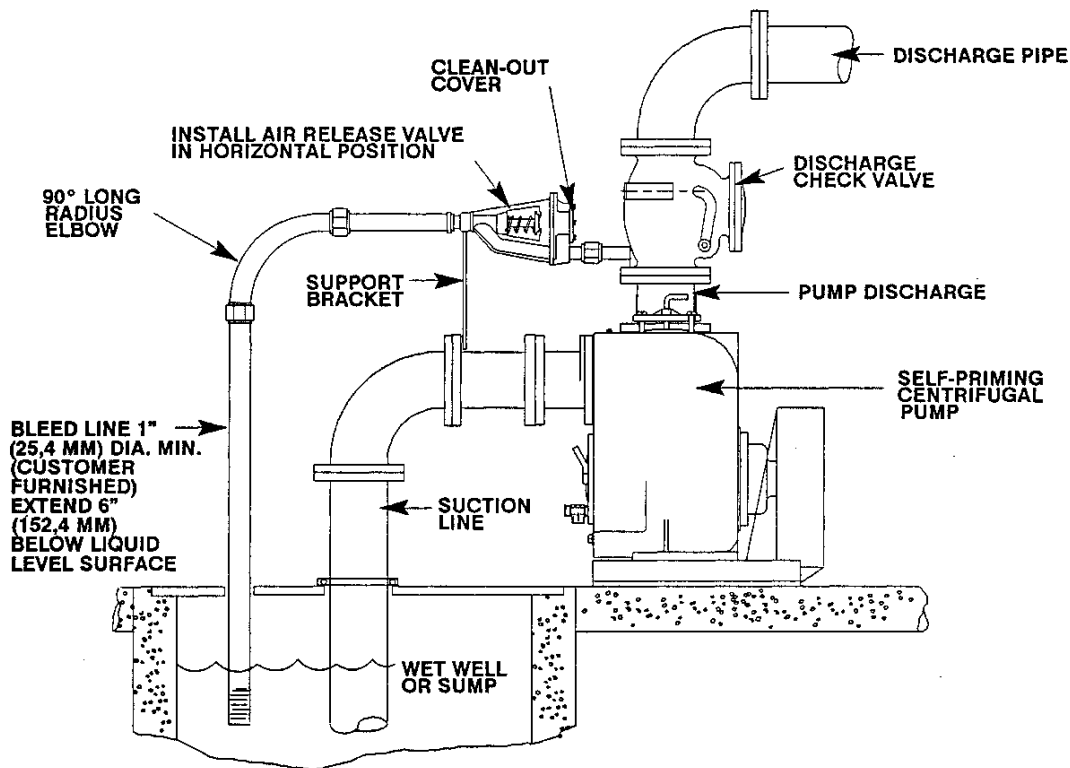

Figure 5. Typical Automatic Air Release Valve Installation

The valve inlet line must be installed between the pump discharge port and the non-pressurized side of the discharge check valve. The valve inlet is at the large end of the valve body, and is provided with standard 1 inch NPT pipe threads.

The valve outlet is located at the opposite end of the valve, and is also equipped with standard 1 inch NPT pipe threads. The outlet should be connected to a bleed line which slopes back to the wet well or sump. The bleed line must be the same size as the inlet piping, or larger. If piping is used for the bleed line, avoid the use of elbows whenever possible.

NOTE

It is recommended that each Air Release Valve be fitted with an independent bleeder line directed back to the wet well. However, if multiple Air Release Valves are installed in a system, the bleeder lines may be directed to a common manifold pipe. Contact your Gorman-Rupp distributor or the Gorman-Rupp Company for information about installation of an Automatic Air Release Valve for your specific application.

ALIGNMENT

The alignment of the pump and engine is critical for trouble-free mechanical operation. The driver and pump must be mounted so that their shafts are aligned with and parallel to each other.

When mounted at the Gorman-Rupp factory, driver and pump are aligned before shipment. Misalignment can occur in transit and handling. Pumps should be checked, and realigned if necessary, before being put into operation. Before checking alignment, tighten the hardware securing the pump to the base.



WHEN CHECKING ALIGNMENT, DISCONNECT THE ENGINE TO ENSURE THAT THE PUMP WILL REMAIN INOPERATIVE.

The axis of the drive unit must be aligned to the axis of the pump shaft in both the horizontal and vertical planes. Most couplings require a specific gap or clearance between the driving and the driven shafts. Refer to the coupling manufacturer's service literature for information.

This pump is furnished with a flexible coupling. To check alignment, use a feeler gauge or a taper gauge between the coupling halves every 90 de-

grees. The coupling is in alignment when the hubs are the same distance apart at all points.

To check parallel adjustment, lay a straightedge across both coupling halves at the top, bottom, and side. The coupling is in horizontal parallel alignment when the straightedge rests evenly on both halves of the coupling. Use a feeler gauge between the coupling and the straightedge to measure the amount of misalignment.

Coupling and alignment adjustments may be made by loosening the hold-down bolts and shifting the driver and/or pump, or by shimming as required.

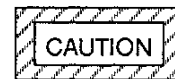

ADJUSTING THE ALIGNMENT IN ONE DIRECTION MAY ALTER THE ALIGNMENT IN ANOTHER DIRECTION. CHECK EACH PROCEDURE AFTER ALTERING ALIGNMENT.

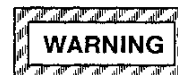

DO NOT OPERATE THE PUMP WITHOUT THE COUPLING GUARD IN PLACE OVER THE ROTATING PARTS. EXPOSED ROTATING PARTS CAN CATCH CLOTHING, FINGERS, OR TOOLS, CAUSING SEVERE INJURY TO PERSONNEL.

OPERATION - SECTION C

Review all warnings in Section A.

Follow the instructions on all tags, labels and decals attached to the pump.



THIS PUMP IS DESIGNED TO HANDLE MOST NON-VOLATILE, NON-FLAMMABLE LIQUIDS CONTAINING SPECIFIED ENTRAINED SOLIDS. DO NOT ATTEMPT TO PUMP VOLATILE, CORROSIVE, OR FLAMMABLE LIQUIDS WHICH MAY DAMAGE THE PUMP OR ENDANGER PERSONNEL AS A RESULT OF PUMP FAILURE.



NEVER TAMPER WITH THE GOVERNOR TO GAIN MORE POWER. THE GOVERNOR ESTABLISHES SAFE OPERATING LIMITS THAT SHOULD NOT BE EXCEEDED. THE MAXIMUM CONTINUOUS OPERATING SPEED FOR THIS PUMP IS 1800 RPM.

PRIMING

Install the pump and piping as described in **INSTALLATION**. Make sure that the piping connections are tight, and that the pump is securely mounted. Check that the pump is properly lubricated (see **LUBRICATION** in **MAINTENANCE AND REPAIR**).

This pump is self-priming, but the pump should never be operated unless there is liquid in the pump casing.

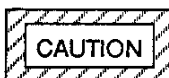

NEVER OPERATE THIS PUMP UNLESS THERE IS LIQUID IN THE PUMP CASING. THE PUMP WILL NOT PRIME WHEN DRY. EXTENDED OPERATION

OF A DRY PUMP WILL DESTROY THE SEAL ASSEMBLY.

Add liquid to the pump casing when:

1. The pump is being put into service for the first time.
2. The pump has not been used for a considerable length of time.
3. The liquid in the pump casing has evaporated.

Once the pump casing has been filled, the pump will prime and reprime as necessary.



AFTER FILLING THE PUMP CASING, REINSTALL AND TIGHTEN THE FILL PLUG. DO NOT ATTEMPT TO OPERATE THE PUMP UNLESS ALL CONNECTING PIPING IS SECURELY INSTALLED. OTHERWISE, LIQUID IN THE PUMP FORCED OUT UNDER PRESSURE COULD CAUSE INJURY TO PERSONNEL.

To fill the pump, remove the pump casing fill cover or fill plug in the top of the casing, and add clean liquid until the casing is filled. Replace the fill cover or fill plug before operating the pump.

STARTING

Consult the operations manual furnished with the engine.

OPERATION

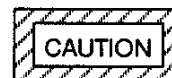

PUMP SPEED AND OPERATING CONDITION POINTS MUST BE WITHIN THE CONTINUOUS PERFORMANCE RANGE SHOWN ON THE CURVE. (SEE SECTION E, PAGE 1.)

Lines With a Bypass

Close the discharge throttling valve (if so equipped) so that the pump will not have to prime against the

weight of the liquid in the discharge line. Air from the suction line will be discharged through the bypass line back to the wet well during the priming cycle. When the pump is fully primed and liquid is flowing steadily from the bypass line, open the discharge throttling valve. Liquid will then continue to circulate through the bypass line while the pump is in operation.

Lines Without a Bypass

Open all valves in the discharge line and start the engine. Priming is indicated by a positive reading on the discharge pressure gauge or by a quieter operation. The pump may not prime immediately because the suction line must first fill with liquid. If the pump fails to prime within five minutes, stop it and check the suction line for leaks.

After the pump has been primed, partially close the discharge line throttling valve in order to fill the line slowly and guard against excessive shock pressure which could damage pipe ends, gaskets, sprinkler heads, and any other fixtures connected to the line. When the discharge line is completely filled, adjust the throttling valve to the required flow rate.

Leakage

No leakage should be visible at pump mating surfaces, or at pump connections or fittings. Keep all line connections and fittings tight to maintain maximum pump efficiency.

Liquid Temperature And Overheating

The **maximum** liquid temperature for this pump is 110° F (43°C). Do not apply it at a higher operating temperature.

Overheating can occur if operated with the valves in the suction or discharge lines closed. Operating against closed valves could bring the liquid to a boil, build pressure, and cause the pump to rupture or explode. If overheating occurs, stop the pump and allow it to cool before servicing it. Refill the pump casing with cool liquid.



DO NOT REMOVE PLATES, COVERS, GAUGES, PIPE PLUGS, OR FITTINGS FROM AN OVERHEATED PUMP. VAPOR PRESSURE WITHIN THE PUMP CAN CAUSE PARTS BEING DISENGAGED TO BE EJECTED WITH GREAT FORCE. ALLOW THE PUMP TO COOL BEFORE SERVICING.

Strainer Check

If a suction strainer has been shipped with the pump or installed by the user, check the strainer regularly, and clean it as necessary. The strainer should also be checked if pump flow rate begins to drop. If a vacuum suction gauge has been installed, monitor and record the readings regularly to detect strainer blockage.

Never introduce air or steam pressure into the pump casing or piping to remove a blockage. This could result in personal injury or damage to the equipment. If backflushing is absolutely necessary, **liquid pressure** must be limited to 50% of the maximum permissible operating pressure shown on the pump performance curve. (See Section E, Page 1.) If the pump is fitted with a Gorman-Rupp double grease lubricated seal, the maximum incoming pressure must be reduced to 10 p.s.i.

Pump Vacuum Check

With the pump inoperative, install a vacuum gauge in the system, using pipe dope on the threads. Block the suction line and start the pump. At operating speed the pump should pull a vacuum of 20 inches (508,0 mm) or more of mercury. If it does not, check for air leaks in the seal, gasket, or discharge valve.

Open the suction line, and read the vacuum gauge with the pump primed and at operation speed. Shut off the pump. The vacuum gauge reading will immediately drop proportionate to static suction lift, and should then stabilize. If the vacuum reading falls off rapidly after stabilization, an air leak exists. Before checking for the source of the leak, check the point of installation of the vacuum gauge.

STOPPING

Never halt the flow of liquid suddenly. If the liquid being pumped is stopped abruptly, damaging shock

waves can be transmitted to the pump and piping system. Close all connecting valves slowly.

On engine driven pumps, reduce the throttle speed slowly and allow the engine to idle briefly before stopping.



IF THE APPLICATION INVOLVES A HIGH DISCHARGE HEAD, GRADUALLY CLOSE THE DISCHARGE THROTTLING VALVE BEFORE STOPPING THE PUMP.

After stopping the pump, remove the engine ignition key to ensure that the pump will remain inoperative.

Cold Weather Preservation

In below freezing conditions, drain the pump to prevent damage from freezing. Also, clean out any solids by flushing with a hose. Operate the pump for approximately one minute; this will remove any remaining liquid that could freeze the pump rotating parts. If the pump will be idle for more than a few hours, or if it has been pumping liquids containing a large amount of solids, drain the pump, and flush it thoroughly with clean water. To prevent large solids from clogging the drain port and preventing the pump from completely draining, insert a rod or stiff wire in the drain port, and agitate the liquid during the draining process. Clean out any remaining solids by flushing with a hose.

TROUBLESHOOTING – SECTION D

Review all WARNINGS in Section A.



BEFORE ATTEMPTING TO OPEN OR SERVICE THE PUMP:

1. FAMILIARIZE YOURSELF WITH THIS MANUAL.
2. SWITCH OFF THE ENGINE IGNITION AND REMOVE THE KEY TO ENSURE THAT THE PUMP WILL REMAIN INOPERATIVE.
3. ALLOW THE PUMP TO COOL IF OVERHEATED.
4. CHECK THE TEMPERATURE BEFORE OPENING ANY COVERS, PLATES, OR PLUGS.
5. CLOSE THE SUCTION AND DISCHARGE VALVES.
6. VENT THE PUMP SLOWLY AND CAUTIOUSLY.
7. DRAIN THE PUMP.

TROUBLE	POSSIBLE CAUSE	PROBABLE REMEDY
PUMP FAILS TO PRIME	<p>Not enough liquid in casing.</p> <p>Suction check valve contaminated or damaged.</p> <p>Air leak in suction line.</p> <p>Lining of suction hose collapsed.</p> <p>Leaking or worn seal or pump gasket.</p> <p>Suction lift or discharge head too high.</p> <p>Strainer clogged.</p> <p>Suction check valve or foot valve clogged or binding.</p>	<p>Add liquid to casing. See PRIMING.</p> <p>Clean or replace check valve.</p> <p>Correct leak.</p> <p>Replace suction hose.</p> <p>Check pump vacuum. Replace leaking or worn seal or gasket.</p> <p>Check piping installation and install bypass line if needed. See INSTALLATION.</p> <p>Check strainer and clean if necessary.</p> <p>Clean valve</p>
PUMP STOPS OR FAILS TO DELIVER RATED FLOW OR PRESSURE	<p>Air leak in suction line.</p> <p>Lining of suction hose collapsed.</p> <p>Leaking or worn seal or pump gasket.</p> <p>Strainer clogged.</p>	<p>Correct leak.</p> <p>Replace suction hose.</p> <p>Check pump vacuum. Replace leaking or worn seal or gasket.</p> <p>Check strainer and clean if necessary.</p>

TROUBLE	POSSIBLE CAUSE	PROBABLE REMEDY
PUMP STOPS OR FAILS TO DELIVER RATED FLOW OR PRESSURE (cont.)	<p>Suction intake not submerged at proper level or sump too small.</p> <p>Impeller or other wearing parts worn or damaged.</p> <p>Impeller clogged.</p> <p>Pump speed too slow.</p> <p>Suction lift or discharge head too high.</p>	<p>Check installation and correct submergence as needed.</p> <p>Replace worn or damaged parts. Check that impeller is properly centered and rotates freely.</p> <p>Free impeller of debris.</p> <p>Check engine output; consult engine operation manual.</p> <p>Check piping installation and install bypass line if needed. See INSTALLATION.</p>
PUMP REQUIRES TOO MUCH POWER	<p>Pump speed too high.</p> <p>Discharge head too low.</p> <p>Liquid solution too thick.</p> <p>Bearing(s) frozen.</p>	<p>Check engine output.</p> <p>Adjust discharge valve.</p> <p>Dilute if possible.</p> <p>Disassemble pump and check bearing(s).</p>
PUMP CLOGS FREQUENTLY	<p>Liquid solution too thick.</p> <p>Discharge flow too slow.</p> <p>Suction check valve or foot valve clogged or binding.</p>	<p>Dilute if possible.</p> <p>Open discharge valve fully to increase flow rate, and run power source at maximum governed speed.</p> <p>Clean valve.</p>
EXCESSIVE NOISE	<p>Cavitation in pump.</p> <p>Pumping entrained air.</p> <p>Pump or drive not securely mounted.</p> <p>Impeller clogged or damaged.</p>	<p>Reduce suction lift and/or friction losses in suction line. Record vacuum and pressure gauge readings and consult local representative or factory.</p> <p>Locate and eliminate source of air bubble.</p> <p>Secure mounting hardware.</p> <p>Clean out debris; replace damaged parts.</p>

TROUBLE	POSSIBLE CAUSE	PROBABLE REMEDY
BEARINGS RUN TOO HOT	Bearing temperature is high, but within limits. Low or incorrect lubricant. Suction and discharge lines not properly supported. Drive misaligned.	Check bearing temperature regularly to monitor any increase. Check for proper type and level of lubricant. Check piping installation for proper support. Align drive properly.

PUMP MAINTENANCE AND REPAIR - SECTION E

MAINTENANCE AND REPAIR OF THE WEARING PARTS OF THE PUMP WILL MAINTAIN PEAK OPERATING PERFORMANCE.

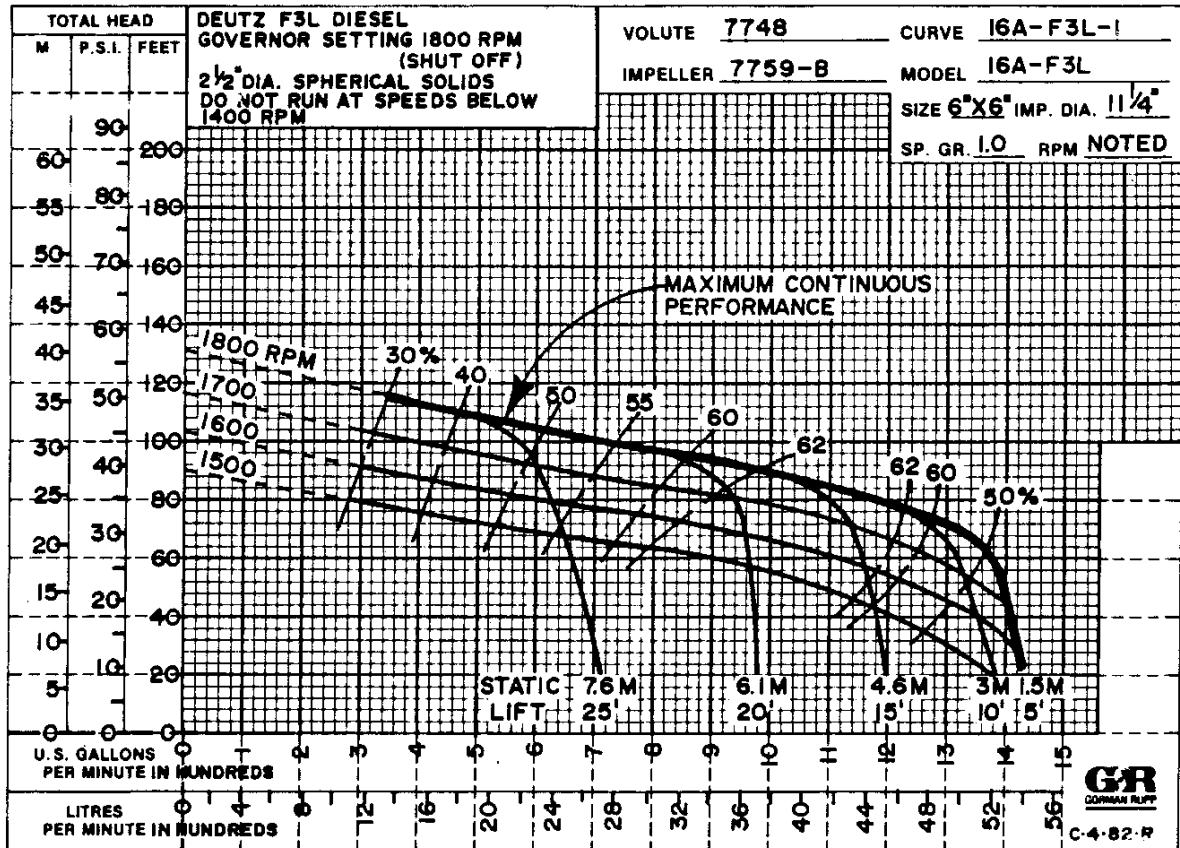

* STANDARD PERFORMANCE FOR PUMP MODEL 16A2-F3L

* Based on 70° F (21° C) clear water at sea level with minimum suction lift. Since pump installations are seldom identical, your performance may be difference due to such factors as viscosity, specific gravity, elevation, temperature, and impeller trim.

Contact the Gorman-Rupp Company to verify performance or part numbers.

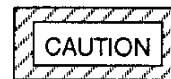

If your pump serial number is followed by an "N", your pump is **NOT** a standard production model.

PUMP SPEED AND OPERATING CONDITION POINTS MUST BE WITHIN THE CONTINUOUS PERFORMANCE RANGE SHOWN ON THE CURVE.

SECTION DRAWING

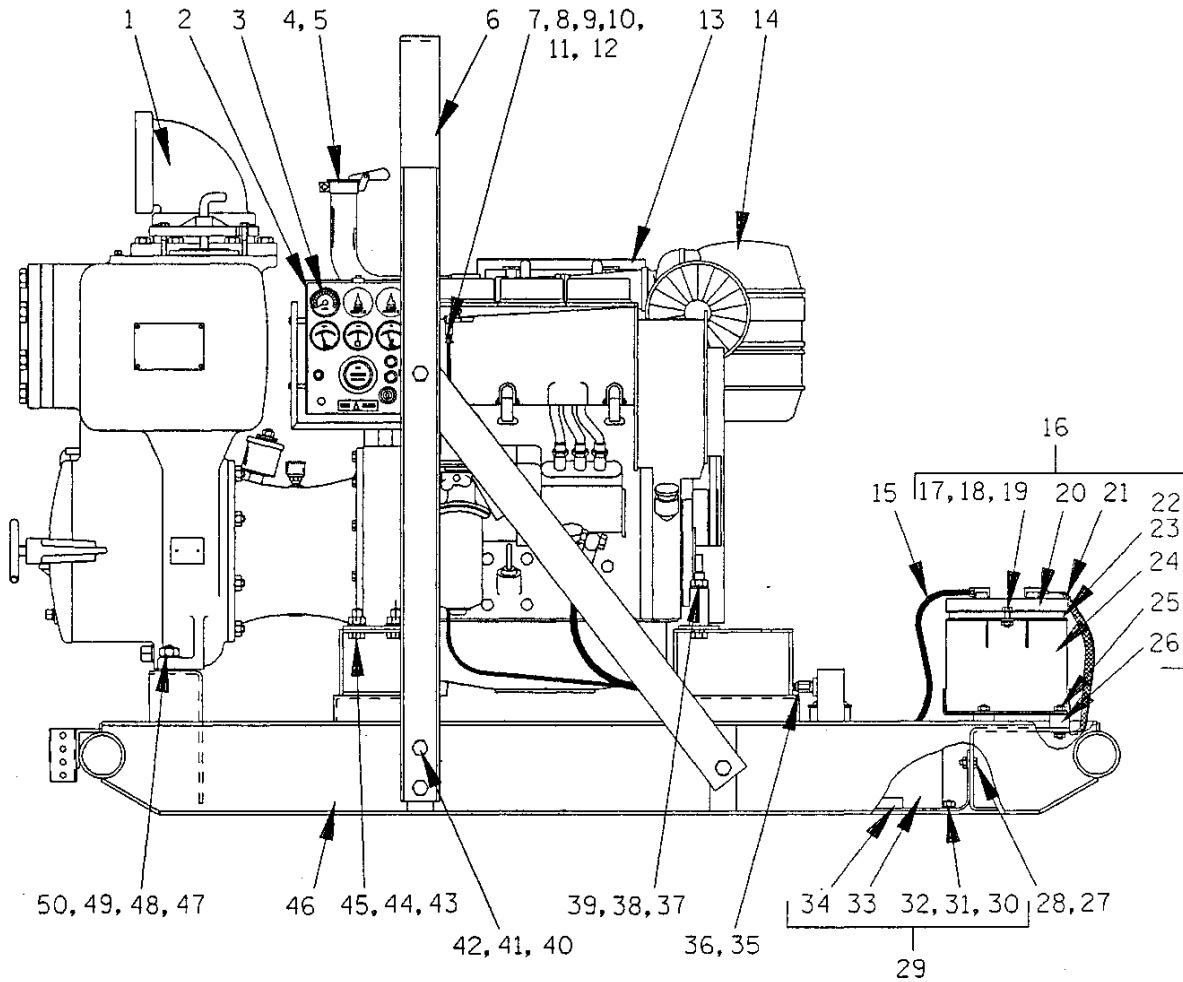

Figure 1. Pump Model 16A2-F3L

PARTS LIST
Pump Model 16A2-F3L
 (From S/N 939607 up)

If your pump serial number is followed by an "N", your pump is **NOT** a standard production model. Contact the Gorman-Rupp Company to verify part numbers.

ITEM NO.	PART NAME	PART NUMBER	MAT'L CODE	QTY	ITEM NO.	PART NAME	PART NUMBER	MAT'L CODE	QTY
1	PUMP END	16A2-(F3L)	-----	1	29	FUEL TANK & GRD ASSY	46711-041	-----	1
2	CAUTION DECAL	2613FJ	-----	2	30	-FLAT WASHER	K06	15991	6
3	TACHOMETER KIT	48312-606	-----	1	31	-LOCKWASHER	J06	15991	6
	-TACHOMETER	26861-021	-----	1	32	-HEX NUT	D06	15991	6
4	EXHAUST ELBOW	31912-023	15990	1	33	-FUEL TANK ASSY	46711-042	24150	1
5	WEATHER CAP	S1331	-----	1	34	-FUEL TANK GRD ASSY	42381-046	24150	1
6	HOISTING BAIL	13351BB	24000	1	35	HOSE INLET ASSY	9072C	-----	1
7	FUEL RETURN LINE	11308F	-----	1	36	MALE CONNECTOR	S1447	-----	1
8	HOSE CLAMP	26518-642	-----	2	37	HEX HD CAPSCREW	B1018	15991	2
9	HOSE BARB FITTING	26523-441	-----	1	38	LOCKWASHER	J10	15991	2
10	MALE CONNECTOR	26523-402	-----	1	39	HEX NUT	D10	15991	2
11	REDUCING ELBOW	Q0402	11990	1	40	HEX HD CAPSCREW	B1006	15991	8
12	FUEL RETURN LINE	14294	24030	1	41	LOCKWASHER	J10	15991	8
13	MUFFLER GUARD ASSY	42331-029	-----	1	42	HEX NUT	D10	15991	8
14	DEUTZ F3L ENGINE	29217-021	-----	1	43	HEX HD CAPSCREW	B1007	15991	4
15	POS CABLE ASSY	6926Q	24040	1	44	LOCKWASHER	J10	15991	4
16	BATTERY BOX ASSY	GRP40-08C	-----	1	46	COMBINATION BASE	41566-659	24150	1
17	-HEX HD CAPSCREW	B0607	15991	2	47	HEX HD CAPSCREW	B1009	15991	2
18	-FLAT WASHER	K06	15991	2	48	LOCKWASHER	J10	15991	2
19	-FLANGED HEX NUT	21765-314	15991	2	49	HEX NUT	D10	15991	2
20	-BATTERY BOX COVER	42113-012	24150	1	50	FLAT WASHER	K10	15991	2
21	-BATTERY BOX	42431-030	24150	1					
22	-GROUND CABLE ASSY	47311-064	-----	1		NOT SHOWN:			
23	-BATTERY TAG	38818-506	-----	1		BELT/FAN GUARD KIT	48157-701		
24	-12V BATTERY	SEE OPTIONS		REF		OPTIONAL:			
25	-FLANGED HEX NUT	21765-314	15991	8		* 12V BATTERY	29331-506	-----	1
26	-STUD MOUNT	24631-006	-----	4		WHEEL KIT	GRP30-248F	-----	1
27	HEX HD CAPSCREW	B0604	15991	10		BELT GRD ANTI-VIBE KIT	48217-801	-----	1
28	FLANGED HEX NUT	21765-314	-----	10		ENG/PUMP ANTI-VIBE KIT	48217-802	-----	1

* INDICATES PARTS RECOMMENDED FOR STOCK

Above Serial Numbers Do Not Apply To Pumps Made In Canada.

CANADIAN SERIAL NO. AND UP

SECTION DRAWING

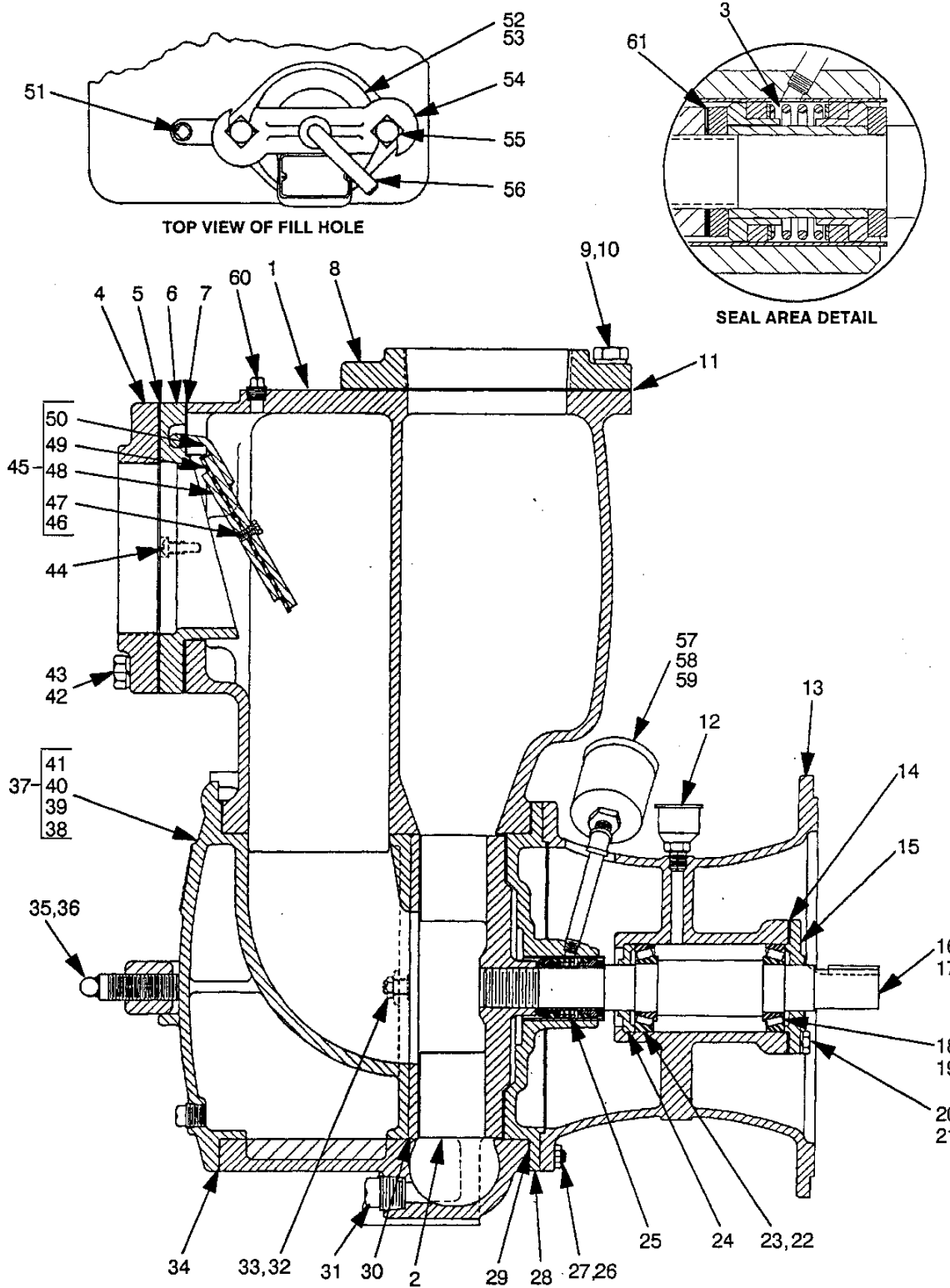

Figure 2. Pump End Assy 16A2-(F3L)

PARTS LIST
Pump End Assy 16A2-(F3L)

ITEM NO.	PART NAME	PART NUMBER	MAT'L CODE	QTY	ITEM NO.	PART NAME	PART NUMBER	MAT'L CODE	QTY
1	PUMP CASING	7748	10010	1	36	COVER CLAMP BAR	2547	11000	1
2 *	IMPELLER	7759-B	11000	1	37	BACK COVER ASSY	42111-932	-----	1
3 *	SEAL ASSY	GS1500	-----	1	38	-WARNING PLATE	2613-EV	13990	1
4	SUCTION FLANGE	1758	10010	1	39	-COVER PLATE	NOT AVAILABLE	-----	1
5 *	SUCT FLANGE GASKET	1679-G	18000	1	40	-DRIVE SCREW	BM#04-03	15990	4
6	CHECK VALVE SEAT	7261	10010	1	41	-DRAIN PLUG	P08	11990	1
7 *	SEAT GASKET	7261-G	18000	1	42	HEX HD CAPSCREW	B1212	15991	8
8	DISCHARGE FLANGE	1758	10010	1	43	LOCKWASHER	J12	15991	8
9	HEX HD CAPSCREW	B1208	15991	8	44	RD HD MACH SCREW	X0404	17090	2
10	LOCKWASHER	J12	15991	8	45	CHECK VALVE ASSY	7265	-----	1
11 *	DISCH FLANGE GASKET	1679-G	18000	1	46	-HEX HD CAPSCREW	B0403	17000	2
12	INTERM GREASE CUP	S35	-----	1	47	-LOCKWASHER	J04	17090	2
13	INTERMEDIATE	36	10010	1	48	-CHECK VALVE WEIGHT	7263	15990	1
14 *	BRG ADJ SHIM SET	48261-031	-----	1	49 *	-CHECK VALVE GSKT	7264	19070	1
15	BEARING CAP	43-X	10010	1	50	-CHECK VALVE WEIGHT	7262	24000	1
16 *	IMPELLER SHAFT	13486	16040	1	51	PIPE PLUG	P04	11990	1
17 *	SHAFT KEY	N0607	15990	1	52	FILL COVER ASSY	42111-344	-----	1
18 *	BEARING CUP	S1086	-----	1	53 *	FILL COVER GSKT	50-G	19210	1
19 *	BEARING CONE	S1087	-----	1	54	FILL COVER CLAMP BAR	38111-004	11000	1
20	HEX HD CAPSCREW	B0604	15991	4	55	MACHINE BOLT	A1014	15991	2
21	LOCKWASHER	J06	15991	4	56	FILL CVR CLAMP SCREW	31912-009	15000	1
22 *	BEARING CUP	S1086	-----	1	57	HEAVY PIPE NIPPLE	THA0416	15070	1
23 *	BEARING CONE	S1087	-----	1	58	PIPE ELBOW	AG04	11990	1
24	BEARING CLOSURE	44	10010	1	59 *	SEAL GREASE CUP	S1509	-----	1
25 *	SEAL LINER	7408	14010	REF	60	PIPE PLUG	P04	11990	1
26	STUD	C0809	15991	8	61 *	IMPELLER SHIM SET	5091	17090	REF
27	HEX NUT	D08	15991	8	NOT SHOWN:				
28	SEAL PLATE	11895-A	10010	1		PIPE NIPPLE	T96	15070	1
29 *	CASING GSKT SET	34-G	18000	1		PIPE ELBOW	R96	11990	1
30 *	WEAR PLATE	2545	15990	1		STRAINER	7823	24000	1
31	CASING DRAIN PLUG	P16	11990	1		NAME PLATE	38818-023	13990	1
32	HEX NUT	D08	15991	2		DRIVE SCREW	BM#04-03	15990	4
33	LOCKWASHER	J08	15991	2		WARNING DECAL	38816-096	-----	1
34 *	COVER GSKT	7668-G	20000	1		SUCTION DECAL	6588-AG	-----	1
35	COVER CLAMP SCREW	2536	24000	1		DISCHARGE DECAL	6588-BJ	-----	1
						PRIMING DECAL	6588-AH	-----	1

* INDICATES PARTS RECOMMENDED FOR STOCK

SECTION DRAWING

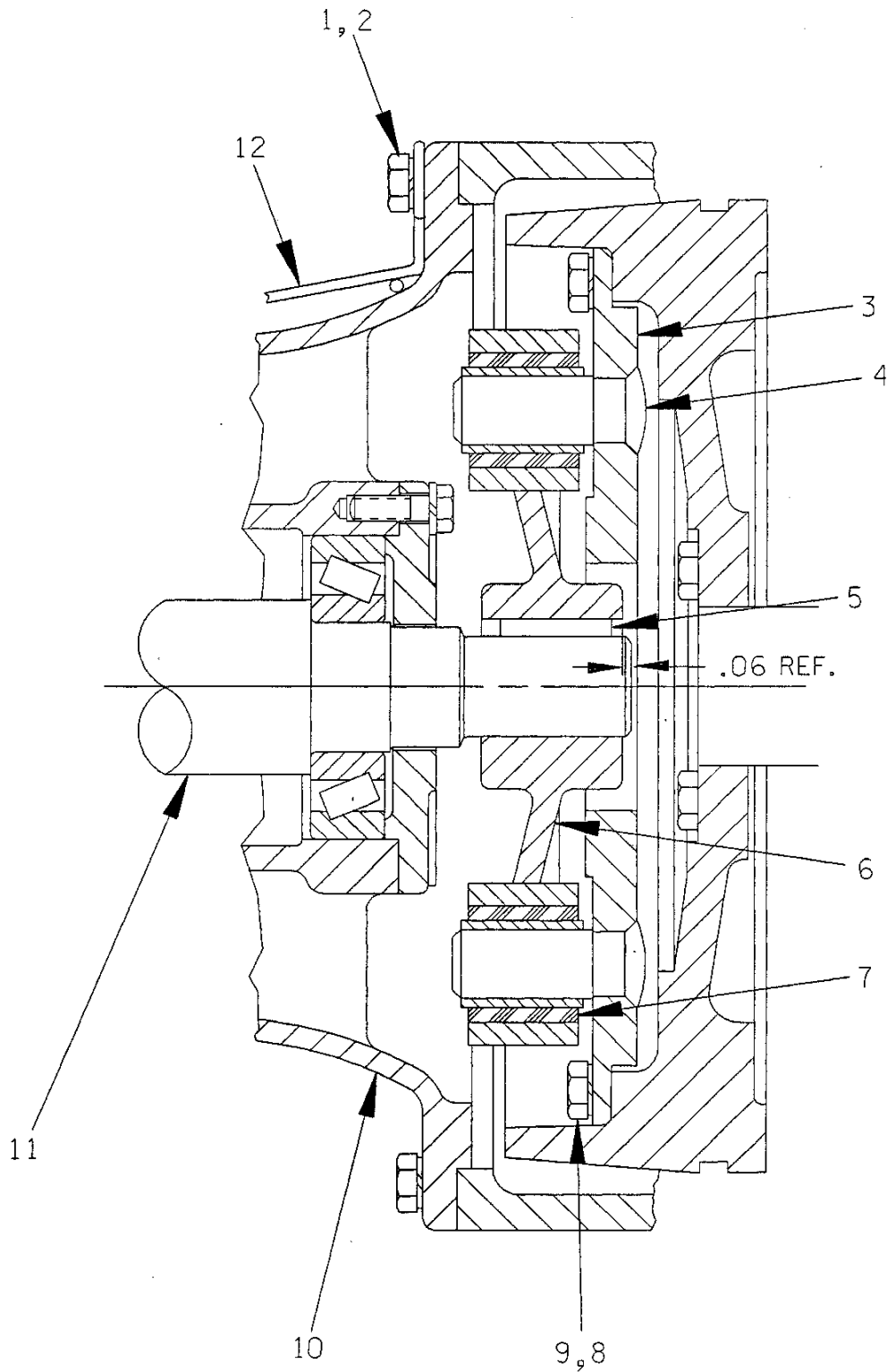

Figure 3. Drive Assembly For 16A2-F3L

PARTS LIST
Drive Assembly For 16A2-F3L

ITEM NO.	PART NAME	PART NUMBER	MAT'L CODE	QTY
1	HEX HD CAPSCREW	22645-164	-----	12
2	LOCKWASHER	21171-511	-----	12
3	DRIVE PLATE ASSEMBLY	44131-005	24150	1
4	-DRIVE PIN	13819	15030	2
5	* SHAFT KEY	N0607	15990	REF
6	DRIVE ARM ASSEMBLY	13817-D	-----	1
7	* -DYNA FLEX JOINT	S2110	-----	2
8	HEX HD CAPSCREW	22645-164	-----	8
9	LOCKWASHER	21171-511	-----	8
10	INTERMEDIATE	36	10010	REF
11	* IMPELLER SHAFT	13486	16040	REF
12	INTERMEDIATE GUARD	42381-031	24150	2

* INDICATES PARTS RECOMMENDED FOR STOCK

PUMP AND SEAL DISASSEMBLY AND REASSEMBLY



Review all warnings in Section A.

Follow the instructions on all tags, label and decals attached to the pump.

This pump requires little service due to its rugged, minimum-maintenance design. However, if it becomes necessary to inspect or replace the wearing parts, follow these instructions which are keyed to the sectional views (see Figures 1, 2, and 3) and the accompanying parts lists.

Most service functions, such as wear plate, impeller, and seal replacement, may be performed by draining the pump and removing the back cover assembly. However, the following instructions assume complete disassembly is required.

Before attempting to service the pump, switch off the engine ignition and remove the key to ensure that it will remain inoperative. Close all valves in the suction and discharge lines.

For engine disassembly and repair, consult the literature supplied with the engine, or contact your local Deutz engine representative.



BEFORE ATTEMPTING TO OPEN OR SERVICE THE PUMP:

1. FAMILIARIZE YOURSELF WITH THIS MANUAL.
2. SWITCH OFF THE ENGINE IGNITION AND REMOVE THE KEY TO ENSURE THAT THE PUMP WILL REMAIN INOPERATIVE.
3. ALLOW THE PUMP TO COOL IF OVERHEATED.
4. CHECK THE TEMPERATURE BEFORE OPENING ANY COVERS, PLATES, OR PLUGS.
5. CLOSE THE SUCTION AND DISCHARGE VALVES.
6. VENT THE PUMP SLOWLY AND CAUTIOUSLY.
7. DRAIN THE PUMP.

USE LIFTING AND MOVING EQUIPMENT IN GOOD REPAIR AND WITH ADEQUATE CAPACITY TO PREVENT INJURIES TO PERSONNEL OR DAMAGE TO EQUIPMENT. THE BAIL IS INTENDED FOR USE IN LIFTING THE PUMP ASSEMBLY ONLY. SUCTION AND DISCHARGE HOSES AND PIPING MUST BE REMOVED FROM THE PUMP BEFORE LIFTING.

Back Cover Removal

(Figure 2)

Before attempting to service the pump, remove the pump casing drain plug (31) and drain the pump. Clean and reinstall the drain plug. The wear plate (30) and check valve (45) are easily accessible and may be serviced by removing the back cover assembly (37).

Remove the cover clamp screw (35) and clamp bar (36) securing the back cover. Pull the back cover and assembled wear plate from the pump casing (1). Inspect the back cover gasket (34) and replace it if damaged or worn.

Inspect the wear plate and replace it if badly scored and worn. To remove the wear plate, disengage the hardware (32 and 33).

Suction Check Valve Removal

(Figure 2)

The check valve assembly (45) may be serviced by removing the suction flange (4). To remove the flange, disengage the hardware (42 and 43) and separate the suction flange from the check valve seat (6). Remove the machine screws (44) and pull the seat and assembled check valve from the suction port. Pull the check valve out of the seat.

Inspect the check valve components for wear or damage. If replacement is required, disengage the hardware (46 and 47) and separate the valve weights (48 and 50) and gasket (49).

Replace the flange gaskets (5 and 7) as required.

Pump Casing Removal

(Figure 1)

To service the impeller or seal assembly, disconnect the suction and discharge piping. Remove the hardware (47, 48, 49 and 50) securing the casing to the base (46).

(Figure 2)

Remove the nuts (27) securing the pump casing to the seal plate (28) and intermediate (13). Use a suitable hoist and sling to separate the pump casing from the seal plate and intermediate.

Remove any leveling shims used under the casing mounting feet. Tie and tag the shims for ease of reassembly.

Impeller Removal

(Figure 2)

Before removing the impeller, turn the cross arm on the automatic lubricating grease cup (59) clockwise until it rests against the cover (see Figure 5). This will prevent the grease from escaping when the impeller is removed.

To loosen the impeller (2), tap the vanes in counter-clockwise direction (when facing the impeller) with a block of wood or soft-faced mallet. **Be careful** not to damage the impeller. When the impeller breaks loose, unscrew it from the shaft. Use caution when removing the impeller; tension on the shaft seal spring will be released as the impeller is unscrewed. Inspect the impeller and replace if cracked or badly worn.

Slide the impeller adjusting shims (61) off the impeller shaft (16). Tie and tag the shims or measure and record their thickness for ease of reassembly.

Seal Removal and Disassembly

(Figure 2)

To remove the seal assembly (3), remove the grease cup and piping (57, 58 and 59), and slide the seal plate (28) and seal parts off the shaft as a single unit. **Be careful** not to drop or damage any seal parts.

Carefully remove the stationary and rotating seal elements, packing rings, seal spring, and shaft sleeve from the seal plate.

NOTE

The seal assembly may be removed without completely disassembling the pump by removing the impeller through the back cover opening and using a stiff wire with a hooked end to pull the seal parts out of the seal plate.

Inspect the seal liner (25) for wear or grooves which could cause leakage or damage to the seal packing rings. The seal liner is a press fit in the seal plate (28), and does not normally require replacement. If replacement is necessary, see **Seal Installation**.

If no further disassembly is required, refer to **Seal Reassembly And Installation**.

Separating Intermediate And Drive Assembly From engine

(Figure 3)

If it is necessary to separate the intermediate and drive assemblies from the engine, support the intermediate using a hoist and sling, and remove the hardware (1 and 2) securing the intermediate (10) to the engine bellhousing. Separate the assemblies by pulling the intermediate straight away from the engine.

As the assemblies are separated, the drive pins will disengage from the drive arm assembly (6). The drive arm assembly and the impeller shaft key (5) are a tight press fit on the shaft (11), and will remain on the shaft.

It is not necessary to remove the drive plate assembly (3) from the engine flywheel unless the drive pins (4) are bent or worn and must be replaced. To remove the drive plate assembly, disengage the hardware (8 and 9) and remove the drive plate.

The drive pins are secured into the drive plate by a tight press fit and peening. To remove the pins, drill through from the peened end and drive the pins out using a drift pin.

Use a bearing puller to remove the drive arm assembly from the impeller shaft. Remove the shaft key.

Inspect the dyna flex joints (7) and replace them if worn. The dyna flex joints are a press fit in the drive arm.

Shaft and Bearing Removal and Disassembly

(Figure 2)

When the pump is properly operated and maintained, the bearing housing should not require disassembly. Disassemble the shaft and bearings **only** when there is evidence of wear or damage.

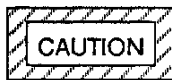

SHAFT AND BEARING DISASSEMBLY IN THE FIELD IS NOT RECOMMENDED. THESE OPERATIONS SHOULD BE PERFORMED ONLY IN A PROPERLY-EQUIPPED SHOP BY QUALIFIED PERSONNEL.

Disengage the hardware (20 and 21), and remove the bearing cap (15) and shims (14). Tie and tag the bearing shims, or measure and record their thickness for ease of reassembly.

Place a block of wood against the impeller end of the shaft (16), and tap the shaft and assembled bearings from the intermediate. **Be careful** not to damage the shaft.

NOTE

There are no provisions for draining the grease from the intermediate cavity. Place a drip pan under the intermediate before removing the shaft and bearings.

Remove the outboard bearing cup (18) from the bearing cone (19).

Place the intermediate on a level surface with the drive side down, and press the bearing closure (24) and inboard bearing cup (22) from the intermediate bore.

After removing the shaft and bearings, clean and inspect the bearings **in place** as follows.

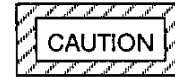

TO PREVENT DAMAGE DURING REMOVAL FROM THE SHAFT, IT IS RECOMMENDED THAT BEARINGS BE CLEANED AND INSPECTED **IN PLACE**. IT IS **STRONGLY** RECOMMENDED THAT THE BEARINGS BE REPLACED **ANY** TIME THE SHAFT AND BEARINGS ARE REMOVED.

Clean the intermediate, shaft and all component parts (except the bearings) with a soft cloth soaked in cleaning solvent. Inspect the parts for wear or damage and replace as necessary.



MOST CLEANING SOLVENTS ARE TOXIC AND FLAMMABLE. USE THEM ONLY IN A WELL-VENTILATED AREA FREE FROM EXCESSIVE HEAT, SPARKS, AND FLAME. READ AND FOLLOW ALL PRECAUTIONS PRINTED ON SOLVENT CONTAINERS.

Clean the bearings thoroughly in **fresh** cleaning solvent. Dry the bearings with filtered compressed air and coat with light oil.

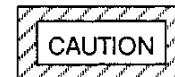

BEARINGS MUST BE KEPT FREE OF ALL DIRT AND FOREIGN MATERIAL. FAILURE TO DO SO WILL GREATLY SHORTEN BEARING LIFE. **DO NOT** SPIN DRY BEARINGS. THIS MAY SCRATCH THE ROLLERS OR RACES, AND CAUSE PREMATURE BEARING FAILURE.

Rotate the bearings by hand to check for roughness or binding and inspect the bearing rollers. If rotation is rough or the rollers are discolored, replace the bearings.

The bearing tolerances provide a tight press fit onto the shaft and a snug slip fit into the bearing housing. Replace the bearing cups or cones, the shaft, or intermediate if the proper bearing fit is not achieved.

If bearing replacement is required, use a bearing puller to remove the inboard and outboard bearing cones (19 and 23) from the shaft.

Shaft and Bearing Reassembly and Installation

(Figure 2)

Inspect the shaft for distortion, nicks or scratches, or for thread damage on the impeller end. Dress small nicks and burrs with a fine file or emery cloth. Replace the shaft if defective.

Clean and inspect the bearings as indicated in **Shaft And Bearing Removal And Disassembly**.

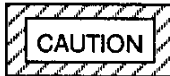

TO PREVENT DAMAGE DURING REMOVAL FROM THE SHAFT, IT IS RECOMMENDED THAT BEARINGS BE CLEANED AND INSPECTED **IN PLACE**. IT IS **STRONGLY** RECOMMENDED THAT THE BEARINGS BE REPLACED **ANY** TIME THE SHAFT AND BEARINGS ARE REMOVED.

The bearings may be heated to ease installation. An induction heater, hot oil bath, electric oven, or hot plate may be used to heat the bearings. Bearings should **never** be heated with a direct flame or directly on a hot plate.

NOTE

*If a hot oil bath is used to heat the bearings, both the oil and the container must be **absolutely** clean. If the oil has been previously used, it must be **thoroughly** filtered.*

Heat the bearings to a uniform temperature **no higher than 250° F (120° C)**, and slide the inboard and outboard bearing cones onto the shaft with the high side of the tapered roller bearings toward the lubrication cavity. This should be done quickly, in one continuous motion, to prevent the bearings from cooling and sticking on the shaft.

After the bearing cones have been installed and allowed to cool, check to ensure that they have not moved away from the shaft shoulders in shrinking. If movement has occurred, use a suitable sized sleeve and a press to reposition the bearings against the shaft shoulders.

If heating the bearings is not practical, use a suitable sized sleeve, and an arbor (or hydraulic) press to install the bearing cones on the shaft.

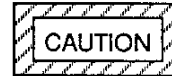

WHEN INSTALLING THE BEARINGS ONTO THE SHAFT, **NEVER** PRESS OR HIT AGAINST THE ROLLERS OR ROLL CAGE. PRESS **ONLY** ON THE INNER RACE.

Pack the bearing cups and cones with No. 0 lithium base grease.

Press the bearing closure (24) and inboard bearing cup (22) into the intermediate until seated squarely against the intermediate shoulder.

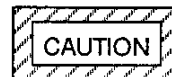

WHEN INSTALLING THE BEARING CUPS INTO THE BEARING BORE, PUSH AGAINST THE OUTER RACE. **NEVER** HIT THE ROLLERS OR ROLL CAGE.

Slide the shaft and assembled bearing cones into the intermediate bore until the inboard bearing cone (23) fully engages the inboard bearing cup. Press the outboard bearing cup (18) over the outboard bearing cone (19).

Install the same thickness of bearing adjusting shims (14) as previously remove, and secure them with the bearing cap (15) and hardware (20 and 21).

NOTE

Shaft endplay should be between .003 and .005 inch (0,08mm to 0,13mm). Add or remove bearing shims to establish the correct endplay.

Lubricate the bearings as indicated in **LUBRICATION** at the end of this section.

Securing Intermediate And Drive Assembly To Engine

(Figure 3)

If the drive pins (4) were removed from the drive plate assembly (3), install the new pins by pressing them into the drive plate and peening the ends. Secure the drive plate assembly to the engine flywheel with the hardware (8 and 9).

If the dyna flex joints (7) were removed from the drive arm assembly, lubricate the O.D. of the replacement

dyna flex joints with a fine film of rubber lubricant (Parker-O-Lube or equivalent), and press them into the drive arm until centered.

Install the impeller shaft key (5) and press the drive arm assembly (6) onto the impeller shaft.



MAKE CERTAIN THAT THE DRIVE PLATE AND DRIVE ARM ASSEMBLIES ARE MOUNTED IN ACCORDANCE WITH THE DIMENSION SHOWN IN FIGURE 3. **THIS DIMENSION IS CRITICAL.** IF THE DRIVE ARM ASSEMBLY IS NOT PROPERLY POSITIONED ON THE SHAFT, A PRELOAD CONDITION CAN CAUSE PREMATURE BEARING FAILURE.

THE END OF THE SHAFT MUST EXTEND COMPLETELY THROUGH THE DRIVE ARM AND PROTRUDE APPROXIMATELY 1/16 OF AN INCH (1,5 MM). THIS WILL ALLOW A CLEARANCE OF APPROXIMATELY 3/32 INCH (2,4 MM) BETWEEN THE DRIVE ARM ASSEMBLY AND THE DRIVE PLATE AFTER THE INTERMEDIATE IS INSTALLED ON THE ENGINE BELLHOUSING.

Seal Reassembly and Installation

(Figures 2 and 4)

Clean the seal cavity and shaft with a cloth soaked in fresh cleaning solvent.

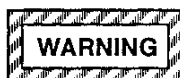

MOST CLEANING SOLVENTS ARE TOXIC AND FLAMMABLE. USE THEM ONLY IN A WELL-

VENTILATED AREA FREE FROM EXCESSIVE HEAT, SPARKS, AND FLAME. READ AND FOLLOW ALL PRECAUTIONS PRINTED ON SOLVENT CONTAINERS.

The seal is not normally reused because wear patterns on the finished faces cannot be realigned during reassembly. This could result in premature failure. If necessary to reuse an old seal in an emergency, **carefully** wash all metallic parts in fresh cleaning solvent and allow to dry thoroughly.

Handle the seal parts with extreme care to prevent damage. Be careful not to contaminate precision finished faces; even fingerprints on the faces can shorten seal life. If necessary, clean the faces with a non-oil based solvent and a clean, lint-free tissue. Wipe **lightly** in a concentric pattern to avoid scratching the faces.

Inspect the seal components for wear, scoring, grooves, and other damage that might cause leakage. Clean and polish the seal spacer sleeve, or replace it if there are nicks or cuts on either end. If any components are worn, replace the complete seal; **never mix old and new seal parts.**

If a replacement seal is being used, remove it from the container and inspect the precision finished faces to ensure that they are free of any foreign matter.

To ease installation of the seal, lubricate the packing rings and seal liner with water or a very **small** amount of oil, and apply a drop of light lubricating oil on the finished faces. Assemble the seal as follows, (see Figure 4).

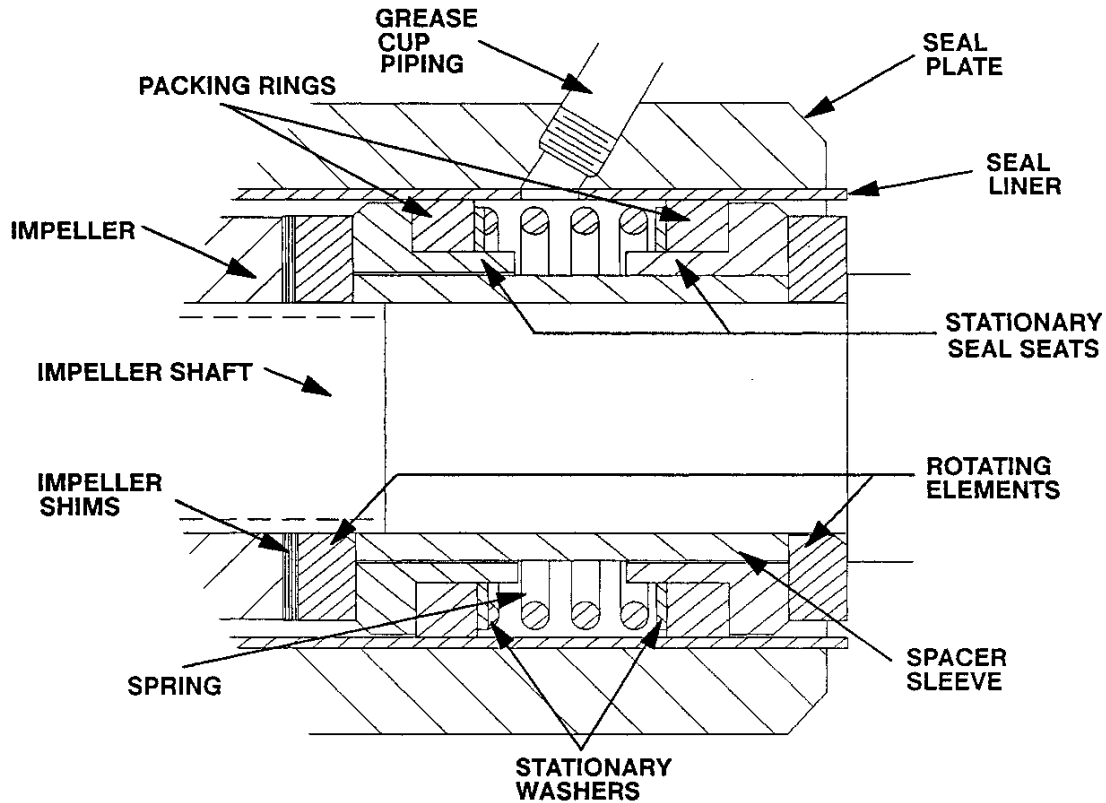
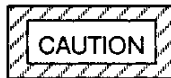

Figure 4. GS1500 Seal Assembly



THIS SEAL IS NOT DESIGNED FOR OPERATION AT TEMPERATURES ABOVE 110° F (43,3° C). DO NOT USE AT HIGHER OPERATING TEMPERATURES.

Inspect the seal plate, the seal liner, and the impeller shaft for burrs or sharp corners, and remove any that exist. Replace the seal liner (25) if wear or grooves exist which could cause leakage or damage to the seal packing rings. To replace the seal liner, position the seal plate (28) on the bed of an arbor (or hydraulic) press, and use a new sleeve to force the old one out. After the new liner is properly installed, a 1/4 inch diameter hole must be drilled through it to permit the flow of lubricant to the seal assembly. **Be careful** to center the drill in the threaded grease pipe hole and not damage the threads. Deburr the hole from the inside of the seal liner after drilling.

Slide the seal plate onto the shaft until fully seated against the intermediate. Align the threaded seal lubricant hole with the intermediate opening, and temporarily secure the seal plate to the intermediate

with two capscrews and nuts (1/2 UNC by 1 1/2 inch long, not supplied).

Slide the inboard rotating element onto the shaft with the chamfered side facing the shaft shoulder.

Subassemble the inboard stationary seat, packing ring and spring washer, and press this subassembly into the lubricated seal liner. A push tube cut from a length of plastic pipe would aid this installation. The O.D. of the pipe should be approximately the same as the O.D. of the seal spring.

Install the spacer sleeve and spring. Subassemble the outboard stationary seat, packing ring and spring washer, and press this subassembly into the lubricated seal liner.

Install the outboard rotating element with the chamfered side facing the impeller.

Reinstall the automatic grease cup and piping (57, 58 and 59).

Lubricate the seal as indicated in **LUBRICATION**, after the impeller has been installed.

Impeller Installation And Adjustment

(Figure 2)

Inspect the impeller, and replace it if cracked or badly worn.

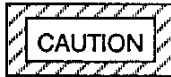

THE SHAFT AND IMPELLER THREADS **MUST** BE COMPLETELY CLEAN BEFORE REINSTALLING THE IMPELLER. EVEN THE SLIGHTEST AMOUNT OF DIRT ON THE THREADS CAN CAUSE THE IMPELLER TO SEIZE TO THE SHAFT, MAKING FUTURE REMOVAL DIFFICULT OR IMPOSSIBLE WITHOUT DAMAGE TO THE IMPELLER OR SHAFT.

Install the same thickness of impeller adjusting shims as previously removed, and screw the impeller onto the shaft until tight.

NOTE

At the slightest sign of binding, immediately back the impeller off, and check the threads for dirt. Do not try to force the impeller onto the shaft.

A clearance of .020 to .040 inch (0,51mm to 1,0mm) between the impeller and the seal plate is necessary for maximum pump efficiency. Measure this clearance, and add or remove impeller adjusting shims as required.

Remove the two capscrews temporarily holding the seal plate, and install the same thickness of casing gaskets (29) as previously removed. Use the lifting device to position the pump casing over the impeller, and secure the seal plate and pump casing to the intermediate with the nuts (27). **Do not** fully tighten the nuts until the impeller face clearance has been set.

A clearance of .010 to .020 inch (0,25mm to 0,51mm) between the impeller and the wear plate is also recommended for maximum pump efficiency. This clearance must be set after installing the back cover, by adding or removing gaskets in the pump casing gasket set (29) until the impeller binds against the wear plate when the shaft is turned. After the impeller binds, add approximately .015 inch (0,4mm) of gaskets.

NOTE

An alternate method of adjusting this clearance is to reach through the discharge port with a feeler gauge and measure the gap. Add or subtract pump casing gaskets accordingly.

(Figure 1)

Install any leveling shims used under the casing mounting feet, and secure the casing to the base with the hardware (47, 48, 49 and 50).

Install the discharge elbow and nipple. Reinstall the fill cover plate (52) and gasket (53) after the pump is completely reassembled and primed.

Suction Check Valve Installation

(Figure 2)

Inspect the check valve components, and replace the parts as required. Subassemble the check valve gasket (49) and weights (48 and 50). Position the assembled check valve in the mounting slot in the seat.

Replace the seat gasket (7) and secure the check valve and seat to the pump casing with the round head machine screws (44).

Replace the suction flange gasket (5) and secure the suction flange to the check valve seat and upmp casing with the hardware (42 and 43).

Back Cover Installation

(Figure 2)

If the wear plate (30) was removed for replacement, carefully center it on the back cover and secure it with the hardware (32 and 33). The wear plate **must** be concentric to prevent binding when the back cover is installed.

Clean any scale or debris from the contacting surfaces in the pump casing that might interfere or prevent a good seal with the back cover. Replace the back cover gasket (34) and slide the back cover assembly into the pump casing. Be sure the wear plate does not bind against the impeller.

NOTE

To ease future disassembly, apply a film of grease or 'Never-Seez' on the back cover shoulder, or any sur-

face which contacts the pump casing. This action will reduce rust and scale build-up.

Secure the back cover assembly by installing the clamp bar (36), and tightening the cover clamp screw (35). Do not over-tighten the clamp screw; it should be just tight enough to ensure a good seal at the back cover shoulder.

Final Pump Assembly

(Figure 1)

Be sure the pump is secured to the base and engine.

Install the suction and discharge lines and open all valves. Make certain that all piping connections are tight, properly supported and secure.

Be sure the pump end and engine have been properly lubricated, see LUBRICATION.

Fill the pump casing with clean liquid. Reinstall the fill cover plate and tighten it.

Refer to OPERATION, Section C, and start the pump.

LUBRICATION

Seal Assembly

(Figure 2)

Fill the grease cup (59) through the grease fitting with No. 2 lithium base grease until grease escapes from the relief hole. Turn the grease cup arm counter-clockwise until it is at the top of the stem; this will release the spring to apply grease to the seal (see Figure 5).

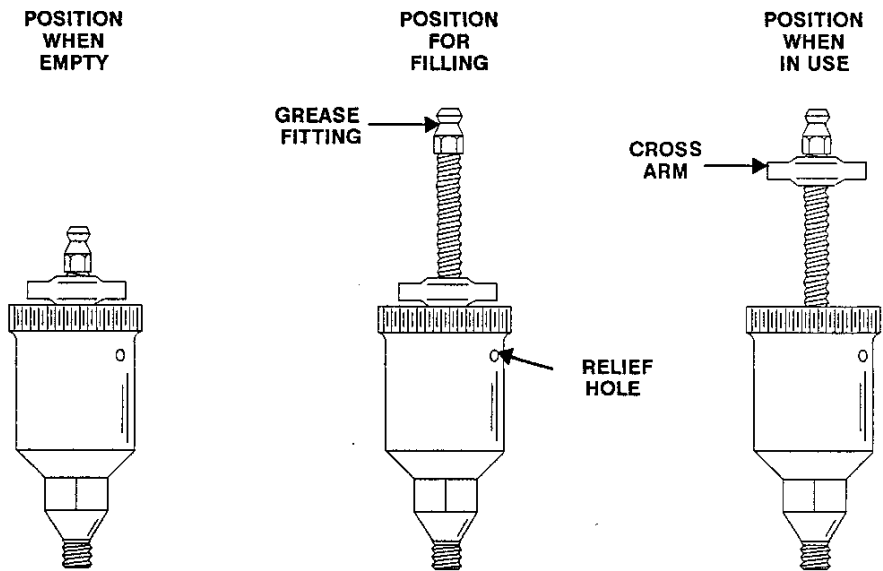

Figure 5. Automatic Lubricating Grease Cup

Bearings

(Figure 2)

The intermediate was fully lubricated when shipped from the factory. Under normal conditions, turn the cap on the grease cup three complete turns to add

grease to the intermediate after each 250 hours of operation (or once each month, whichever comes first). Do not over-lubricate. Over-lubrication can cause the bearings to over-heat, resulting in premature bearing failure. When the grease cup is empty, refill it with No. 0 lithium base grease.



IF GREASE IS FORCED OUT AROUND THE SHAFT AS NEW GREASE IS ADDED, THE BEARING CAVITY IS FULL AND SHOULD BE DISASSEMBLED AND CLEANED IMMEDIATELY.

There are no provisions in the bearing cavity to drain or flush the lubricant. The pump and intermediate must be disassembled to completely clean and maintain this cavity.

Under normal conditions, change the grease after each 5000 hours of operation, or at 12 month intervals, whichever comes first. Change the grease more frequently if the pump is operated continu-

ously or installed in an environment where variable hot and cold temperatures are common.

When lubricating a dry (overhauled) intermediate, fill the cavity through the grease cup with approximately one-sixth of a pound (0,076 kg) of grease (approximately one-third full).

For cold weather operation, consult the factory or a lubricant supplier for the recommended grade of lubricant.

Engine

Consult the literature supplied with the power source, or contact your local Deutz engine representative.

**For U.S. and International Warranty Information,
Please Visit www.grpumps.com/warranty**

or call:

U.S.: 419-755-1280

International: +1-419-755-1352

**For Canadian Warranty Information,
Please Visit www.grcanada.com/warranty**

or call:

519-631-2870

THE GORMAN-RUPP COMPANY • MANSFIELD, OHIO

GORMAN-RUPP OF CANADA LIMITED • ST. THOMAS, ONTARIO, CANADA