**INSTALLATION, OPERATION,
AND MAINTENANCE MANUAL**
WITH PARTS LIST



VG SERIES PUMP

MODEL
VG3B3-B

THE GORMAN-RUPP COMPANY • MANSFIELD, OHIO

GORMAN-RUPP OF CANADA LIMITED • ST. THOMAS, ONTARIO, CANADA Printed in U.S.A.

©Copyright by the Gorman-Rupp Company 1989

TABLE OF CONTENTS

INTRODUCTION	PAGE I - 1
WARNINGS - SECTION A	PAGE A - 1
INSTALLATION - SECTION B	PAGE B - 1
Pump Dimensions	PAGE B - 1
PREINSTALLATION INSPECTION	PAGE B - 2
POSITIONING PUMP	PAGE B - 2
Lifting	PAGE B - 2
Mounting	PAGE B - 2
SUCTION AND DISCHARGE PIPING	PAGE B - 2
Materials	PAGE B - 2
Line Configuration	PAGE B - 3
Connections to Pump	PAGE B - 3
Gauges	PAGE B - 3
SUCTION LINES	PAGE B - 3
Fittings	PAGE B - 3
Strainers	PAGE B - 3
Sealing	PAGE B - 3
Suction Lines In Sumps	PAGE B - 3
Suction Line Positioning	PAGE B - 4
DISCHARGE LINES	PAGE B - 4
Siphoning	PAGE B - 4
Valves	PAGE B - 4
ALIGNMENT	PAGE B - 5
Coupled Drives	PAGE B - 5
V-Belt Drives	PAGE B - 6
OPERATION - SECTION C	PAGE C - 1
PRIMING	PAGE C - 1
Hand Primers	Page C - 1
Exhaust Primers	Page C - 1
Auxiliary Ejectors	Page C - 2
Vacuum Pumps	Page C - 2
STARTING	PAGE C - 2
Rotation	Page C - 2
OPERATION	PAGE C - 2
Leakage	PAGE C - 2
Liquid Temperature And Overheating	PAGE C - 2
Strainer Check	PAGE C - 3
Pump Vacuum Check	PAGE C - 3
STOPPING	PAGE C - 3
Cold Weather Preservation	PAGE C - 3
BEARING TEMPERATURE CHECK	PAGE C - 4
TROUBLESHOOTING - SECTION D	PAGE D - 1

TABLE OF CONTENTS
(continued)

PUMP MAINTENANCE AND REPAIR – SECTION E	PAGE E – 1
STANDARD PERFORMANCE CURVE	PAGE E – 1
PUMP MODEL – PARTS LIST	PAGE E – 3
PUMP AND SEAL DISASSEMBLY AND REASSEMBLY	PAGE E – 4
Impeller Removal	PAGE E – 4
Seal Removal	PAGE E – 4
Shaft And Bearing Removal And Disassembly	PAGE E – 5
Shaft And Bearing Reassembly And Installation	PAGE E – 5
Seal Reassembly and Installation	PAGE E – 6
Impeller Installation	PAGE E – 8
Final Pump Assembly	PAGE E – 8
LUBRICATION	PAGE E – 8
Seal Assembly	PAGE E – 8
Bearings	PAGE E – 8
Power Source	PAGE E – 9

INTRODUCTION

This Installation, Operation, and Maintenance manual is designed to help you achieve the best performance and longest life from your Gorman-Rupp pump.

This pump is a VG Series, enclosed impeller, cen-

trifugal model with straight-in suction without a suction check valve. The pump is designed for high pressure distribution of liquids containing specified entrained solids. The basic material of construction for wetted parts is gray iron. Be sure the liquid being pumped is compatible with this material.

If there are any questions regarding the pump or its application which are not covered in this manual or in other literature accompanying this unit, please contact your Gorman-Rupp distributor, or write:

The Gorman-Rupp Company
P.O. Box 1217
Mansfield, Ohio 44901-1217

or

Gorman-Rupp of Canada Limited
70 Burwell Road
St. Thomas, Ontario N5P 3R7

For information or technical assistance on the power source, contact the power source manufacturer's local dealer or representative.

The following are used to alert maintenance personnel to procedures which require special attention, to those which could damage equipment, and to those which could be dangerous to personnel:

NOTE

Instructions to aid in installation, operation, and maintenance or which clarify a procedure.

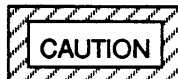

INSTRUCTIONS WHICH MUST BE FOLLOWED TO AVOID CAUSING DAMAGE TO THE PRODUCT OR OTHER EQUIPMENT INCIDENTAL TO THE INSTALLATION. THESE INSTRUCTIONS DESCRIBE THE REQUIREMENTS AND THE POSSIBLE DAMAGE WHICH COULD RESULT FROM FAILURE TO FOLLOW THE PROCEDURES.



THESE INSTRUCTIONS MUST BE FOLLOWED TO AVOID CAUSING INJURY OR DEATH TO PERSONNEL, AND DESCRIBE THE PROCEDURE REQUIRED AND THE INJURY WHICH COULD RESULT FROM FAILURE TO FOLLOW THE PROCEDURE.

WARNINGS – SECTION A

THESE WARNINGS APPLY TO VG SERIES BASIC PUMPS. GORMAN-RUPP HAS NO CONTROL OVER OR PARTICULAR KNOWLEDGE OF THE POWER SOURCE WHICH WILL BE USED. REFER TO THE MANUAL ACCOMPANYING THE POWER SOURCE BEFORE ATTEMPTING TO BEGIN OPERATION.



BEFORE ATTEMPTING TO OPEN OR SERVICE THE PUMP:

1. FAMILIARIZE YOURSELF WITH THIS MANUAL.
2. DISCONNECT OR LOCK OUT THE POWER SOURCE TO ENSURE THAT THE PUMP WILL REMAIN INOPERATIVE.
3. ALLOW THE PUMP TO COOL IF OVERHEATED.
4. CHECK THE TEMPERATURE BEFORE OPENING ANY COVERS, PLATES, OR PLUGS.
5. CLOSE THE SUCTION AND DISCHARGE VALVES.
6. VENT THE PUMP SLOWLY AND CAUTIOUSLY.
7. DRAIN THE PUMP.



THIS PUMP IS DESIGNED TO HANDLE LIQUIDS CONTAINING SPECIFIED ENTRAINED SOLIDS. DO NOT ATTEMPT TO PUMP VOLATILE, CORROSIVE, OR FLAMMABLE MATERIALS, OR ANY LIQUIDS WHICH MAY DAMAGE THE PUMP OR ENDANGER PERSONNEL AS A RESULT OF PUMP FAILURE.



AFTER THE PUMP HAS BEEN POSITIONED, MAKE CERTAIN THAT THE PUMP AND ALL PIPING CONNECTIONS ARE TIGHT, PROPERLY SUPPORTED AND SECURE BEFORE OPERATION.



DO NOT OPERATE THE PUMP WITHOUT THE SHIELDS AND/OR GUARDS IN PLACE OVER THE ROTATING PARTS. EXPOSED ROTATING PARTS CAN CATCH CLOTHING, FINGERS, OR TOOLS, CAUSING SEVERE INJURY TO PERSONNEL.



OVERHEATED PUMPS CAN CAUSE SEVERE BURNS AND INJURIES. IF OVERHEATING OF THE PUMP OCCURS:

1. STOP THE PUMP IMMEDIATELY.
2. VENTILATE THE AREA.
3. ALLOW THE PUMP TO COOL.
4. CHECK THE TEMPERATURE BEFORE OPENING ANY COVERS, PLATES, GAUGES, OR PLUGS.
5. VENT THE PUMP SLOWLY AND CAUTIOUSLY.
6. REFER TO INSTRUCTIONS IN THIS MANUAL BEFORE RESTARTING THE PUMP.



DO NOT REMOVE PLATES, COVERS, GAUGES, PIPE PLUGS, OR FITTINGS FROM AN OVERHEATED PUMP. VAPOR PRESSURE WITHIN THE PUMP CAN CAUSE PARTS BEING DISENGAGED TO BE EJECTED WITH GREAT FORCE. ALLOW THE PUMP TO COOL BEFORE SERVICING.

INSTALLATION - SECTION B

Review all WARNINGS in Section A.

Since pump installations are seldom identical, this section offers only general recommendations and practices required to inspect, position, and arrange the pump and piping.

Most of the information pertains to a standard **static lift application where the pump is positioned above the free level of liquid to be pumped.**

If installed in a **flooded suction application where the liquid is supplied to the pump under pressure,** some of the information such as mounting, line configuration, and priming must be tailored to the spe-

cific application. Since the pressure supplied to the pump is critical to performance and safety, **be sure to limit the incoming pressure to 50% of the maximum permissible operating pressure as shown on the pump performance curve.**

For further assistance, contact your Gorman-Rupp distributor or the Gorman-Rupp Company.

Pump Dimensions

See Figure 1 for the approximate physical dimensions of this pump.

OUTLINE DRAWING

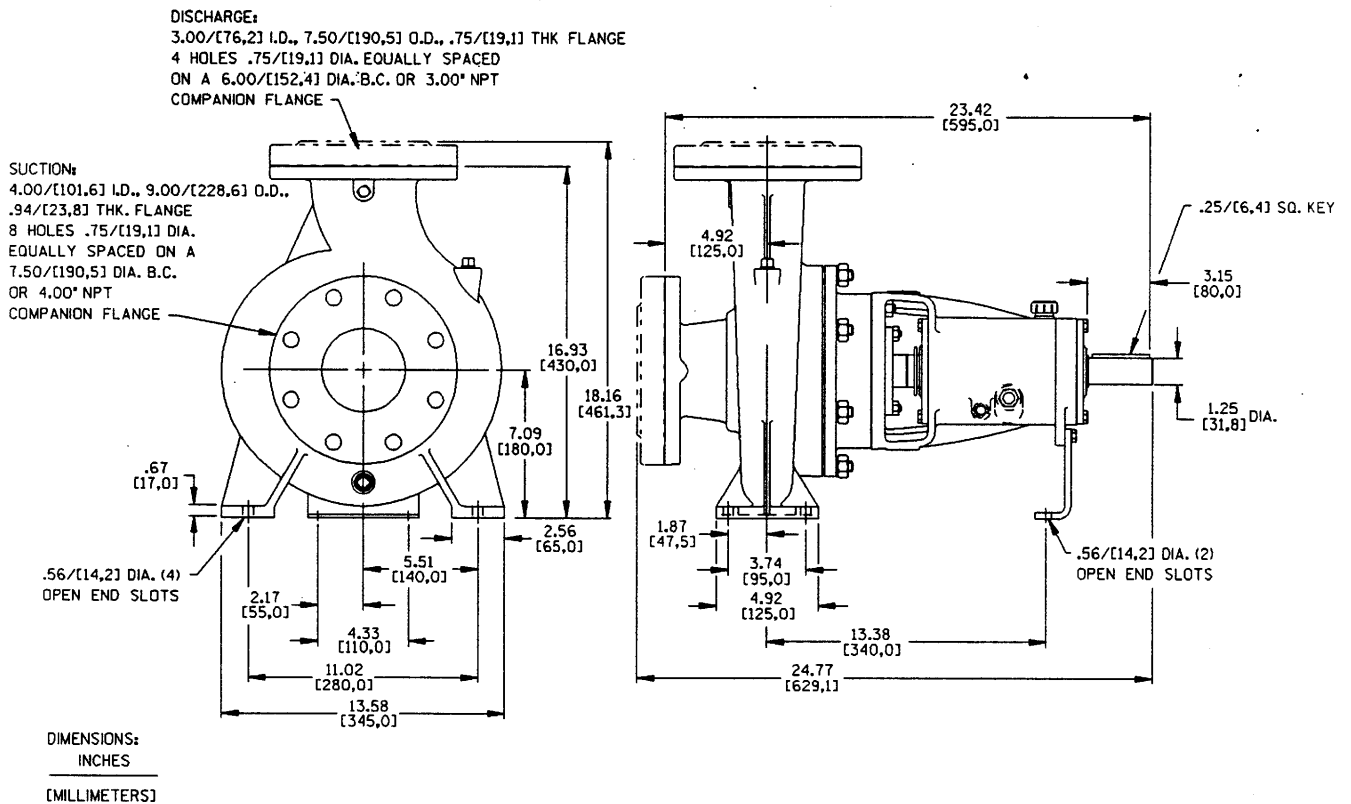

Figure 1. Pump Model VG3B3-B

PREINSTALLATION INSPECTION

The pump assembly was inspected and tested before shipment from the factory. Before installation, inspect the pump for damage which may have occurred during shipment. Check as follows:

- a. Inspect the pump for cracks, dents, damaged threads, and other obvious damage.
- b. Check for and tighten loose attaching hardware. Since gaskets tend to shrink after drying, check for loose hardware at mating surfaces.
- c. Carefully read all warnings and cautions contained in this manual or affixed to the pump, and perform all duties indicated. Note the direction of rotation indicated on the pump. Check that the pump shaft rotates counter-clockwise when facing the pump suction.



ONLY OPERATE THIS PUMP IN THE DIRECTION INDICATED BY THE ARROW ON THE PUMP BODY AND ON THE ACCOMPANYING DECAL. OTHERWISE, PUMP PERFORMANCE WILL BE ADVERSELY AFFECTED, AND THE PUMP COULD BE SERIOUSLY DAMAGED. REFER TO ROTATION in OPERATION, SECTION C.

- d. Check all lubricant levels and lubricate as necessary. Refer to **LUBRICATION** in the **MAINTENANCE AND REPAIR** section of this manual and perform duties as instructed.
- e. If the pump and power source have been stored for more than 12 months, some of the components or lubricants may have exceeded their maximum shelf life. These **must be inspected or replaced** to ensure maximum pump service.

If the maximum shelf life has been exceeded, or if anything appears to be abnormal, contact your Gorman-Rupp distributor or the factory to determine the repair or updating policy. **Do not** put the pump into service until appropriate action has been taken.

POSITIONING PUMP

Lifting

Use lifting equipment with a capacity of at least **650 pounds (294,84 kg)**. This pump weighs approximately **130 pounds (58,97 kg)**, not including the weight of accessories and base. Customer installed equipment such as suction and discharge piping **must be removed** before attempting to lift.



THE PUMP ASSEMBLY CAN BE SERIOUSLY DAMAGED IF THE CABLES OR CHAINS USED TO LIFT AND MOVE THE UNIT ARE IMPROPERLY WRAPPED AROUND THE PUMP.

Mounting

Locate the pump in an accessible place as close as practical to the liquid being pumped. Level mounting is essential for proper operation.

The pump may have to be supported or shimmed to provide for level operation or to eliminate vibration.

SUCTION AND DISCHARGE PIPING

The size of the system piping is **not** always determined by the nominal suction and discharge port diameter. Factors such as suction lift, discharge elevation, and friction losses for the complete system must be considered to be sure your application allows the pump to operate within the safe operating range shown on page E-1. In any case, the suction line should never be smaller than the pump inlet.

Materials

Either pipe or hose may be used for suction and discharge lines; however, the materials must be compatible with the liquid being pumped. If hose is used in suction lines, it must be the rigid-wall, reinforced

type to prevent collapse under suction. Using piping couplings in suction lines is not recommended.

Line Configuration

Keep suction and discharge lines as straight as possible to minimize friction losses. Make minimum use of elbows and fittings, which substantially increase friction loss. If elbows are necessary, use the long-radius type to minimize friction loss.

Connections to Pump

Before tightening a connecting flange, align it exactly with the pump port. Never pull a pipe line into place by tightening the flange bolts and/or couplings.

Lines near the pump must be independently supported to avoid strain on the pump which could cause excessive vibration, decreased bearing life, and increased shaft and seal wear. If hose-type lines are used, they should have adequate support to secure them when filled with liquid and under pressure.

Gauges

Most pumps are drilled and tapped for installing discharge pressure and vacuum suction gauges. If these gauges are desired for pumps that are not tapped, drill and tap the suction and discharge lines not less than 18 inches (457,2 mm) from the suction and discharge ports and install the lines. Installation closer to the pump may result in erratic readings.

SUCTION LINES

To avoid air pockets which could affect pump priming, the suction line must be as short and direct as possible. When operation involves a suction lift, the line must always slope upward to the pump from the source of the liquid being pumped; if the line slopes down to the pump at any point along the suction run, air pockets will be created.

Fittings

Suction lines should be the same size as the pump inlet. If reducers are used in suction lines, they should be the eccentric type, and should be installed with the flat part of the reducers uppermost to avoid creating air pockets. Valves are not normally used in suction lines, but if a valve is used, install it with the stem horizontal to avoid air pockets.

Strainers

If a strainer is furnished with the pump, be certain to use it; any spherical solids which pass through a strainer furnished with the pump will also pass through the pump itself.

If a strainer is not furnished with the pump, but is installed by the pump user, make certain that the total area of the openings in the strainer is at least three or four times the cross section of the suction line, and that the openings will not permit passage of solids larger than the solids handling capability of the pump.

This pump is designed to handle up to 13/16 inch ((20,6 mm) diameter spherical solids.

Sealing

Since even a slight leak will affect priming, head, and capacity, especially when operating with a high suction lift, all connections in the suction line should be sealed with pipe dope to ensure an airtight seal. Follow the sealant manufacturer's recommendations when selecting and applying the pipe dope. The pipe dope should be compatible with the liquid being pumped.

Suction Lines In Sumps

If a single suction line is installed in a sump, it should be positioned away from the wall of the sump at a distance equal to 1 1/2 times the diameter of the suction line.

If there is a liquid flow from an open pipe into the sump, the flow should be kept away from the suction inlet because the inflow will carry air down into the sump, and air entering the suction line will reduce pump efficiency.

If it is necessary to position inflow close to the suction inlet, install a baffle between the inflow and the

suction inlet at a distance 1 1/2 times the diameter of the suction pipe. The baffle will allow entrained air to escape from the liquid before it is drawn into the suction inlet.

If two suction lines are installed in a single sump, the flow paths may interact, reducing the efficiency of one or both pumps. To avoid this, position the suction inlets so that they are separated by a distance equal to at least 3 times the diameter of the suction pipe.

cal to efficient pump operation. Figure 2 shows recommended minimum submergence vs. velocity.

NOTE

The pipe submergence required may be reduced by installing a standard pipe increaser fitting at the end of the suction line. The larger opening size will reduce the inlet velocity. Calculate the required submergence using the following formula based on the increased opening size (area or diameter).

Suction Line Positioning

The depth of submergence of the suction line is criti-

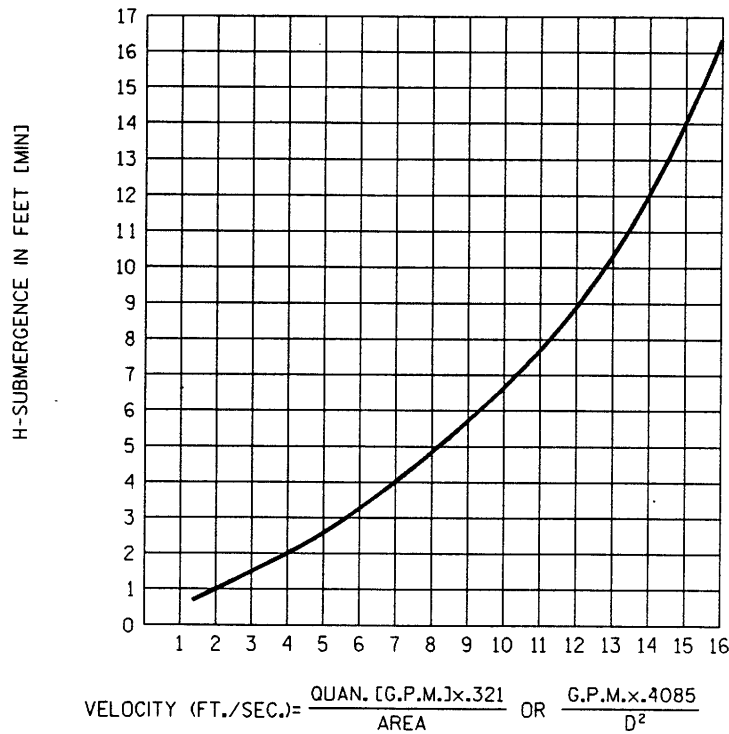

Figure 2. Recommended Minimum Suction Line Submergence vs. Velocity

DISCHARGE LINES

Siphoning

Do not terminate the discharge line at a level lower than that of the liquid being pumped unless a siphon breaker is used in the line. Otherwise, a siphoning action causing damage to the pump could result.

Valves

A check valve in the discharge line is normally recommended, but it is not necessary in low discharge head applications.

If a throttling valve is desired in the discharge line, use a valve as large as the largest pipe to minimize friction losses. Never install a throttling valve in a suction line.

With high discharge heads, it is recommended that a throttling valve and a system check valve be in-

stalled in the discharge line to protect the pump from excessive shock pressure and reverse rotation when it is stopped.



IF THE APPLICATION INVOLVES A HIGH DISCHARGE HEAD, GRADUALLY CLOSE THE DISCHARGE THROTTLING VALVE BEFORE STOPPING THE PUMP.

ALIGNMENT

The alignment of the pump and its power source is critical for trouble-free mechanical operation. In either a flexible coupling or V-belt driven system, the driver and pump must be mounted so that their shafts are aligned with and parallel to each other. It is imperative that alignment be checked after the pump and piping are installed, and before operation.

NOTE

Check Rotation, Section C, before final alignment of the pump.

When mounted at the Gorman-Rupp factory, driver and pump are aligned before shipment. Misalignment will occur in transit and handling. Pumps must be checked and realigned before operation. Before

checking alignment, tighten the foundation bolts. The pump casing feet and/or pedestal feet, and the driver mounting bolts should also be tightly secured.



WHEN CHECKING ALIGNMENT, DISCONNECT THE POWER SOURCE TO ENSURE THAT THE PUMP WILL REMAIN INOPERATIVE.



ADJUSTING THE ALIGNMENT IN ONE DIRECTION MAY ALTER THE ALIGNMENT IN ANOTHER DIRECTION. CHECK EACH PROCEDURE AFTER ALTERING ALIGNMENT.

Coupled Drives

When using couplings, the axis of the power source must be aligned to the axis of the pump shaft in both the horizontal and vertical planes. Most couplings require a specific gap or clearance between the driving and the driven shafts. Refer to the coupling manufacturer's service literature.

Align spider insert type couplings by using calipers to measure the dimensions on the circumference of the outer ends of the coupling hub every 90 degrees. The coupling is in alignment when the hub ends are the same distance apart at all points (see Figure 3A).

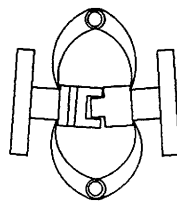

Figure 3A. Aligning Spider Type Couplings

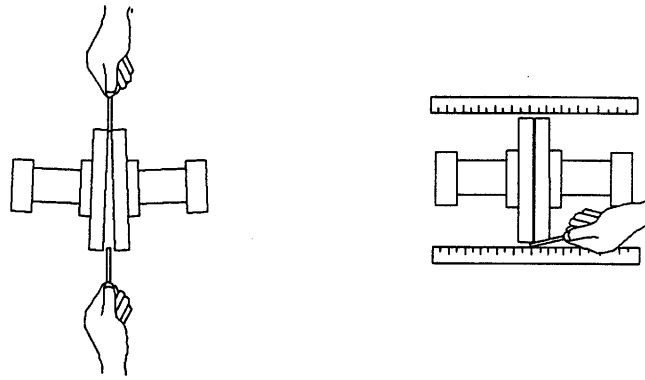

Figure 3B. Aligning Non-Spider Type Couplings

Align non-spider type couplings by using a feeler gauge or taper gauge between the coupling halves every 90 degrees. The coupling is in alignment when the hubs are the same distance apart at all points (see Figure 3B).

straightedge to measure the amount of misalignment.

V-Belt Drives

Check parallel adjustment by laying a straightedge across both coupling rims at the top, bottom, and side. When the straightedge rests evenly on both halves of the coupling, the coupling is in horizontal parallel alignment. If the coupling is misaligned, use a feeler gauge between the coupling and the

When using V-belt drives, the power source and the pump must be parallel. Use a straightedge along the sides of the pulleys to ensure that the pulleys are properly aligned (see Figure 3C). In drive systems using two or more belts, make certain that the belts are a matched set; unmatched sets will cause accelerated belt wear.

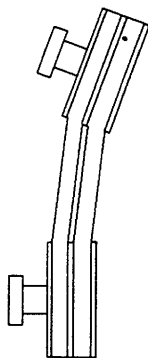

MISALIGNED: SHAFTS NOT PARALLEL

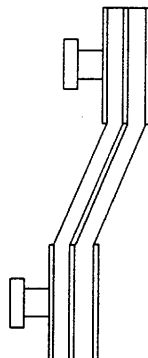

MISALIGNED: SHAFTS NOT IN LINE

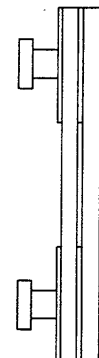

ALIGNED: SHAFTS PARALLEL AND SHEAVES IN LINE

Figure 3C. Alignment of V-Belt Driven Pumps

Tighten the belts in accordance with the belt manufacturer's instructions. If the belts are too loose, they will slip; if the belts are too tight, there will be excessive power loss and possible bearing failure. Select pulleys that will match the proper speed ratio; overspeeding the pump may damage both pump and power source.



DO NOT OPERATE THE PUMP WITHOUT THE GUARD IN PLACE OVER THE ROTATING PARTS. EXPOSED ROTATING PARTS CAN CATCH CLOTHING, FINGERS, OR TOOLS, CAUSING SEVERE INJURY TO PERSONNEL.

OPERATION – SECTION C

Review all warnings in Section A.

Follow the instructions on all tags, labels and decals attached to the pump.



THIS PUMP IS DESIGNED TO HANDLE LIQUIDS CONTAINING SPECIFIED ENTRAINED SOLIDS. DO NOT ATTEMPT TO PUMP VOLATILE, CORROSIVE, OR FLAMMABLE MATERIALS, OR ANY LIQUIDS WHICH MAY DAMAGE THE PUMP OR ENDANGER PERSONNEL AS A RESULT OF PUMP FAILURE.

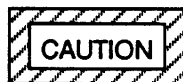

PUMP SPEED AND OPERATING CONDITIONS MUST BE WITHIN THE PERFORMANCE RANGE SHOWN ON PAGE E-1.

PRIMING

Install the pump and piping as described in **INSTALLATION**. Make sure that the piping connections are tight, and that the pump is securely mounted. Check that the pump is properly lubricated (see **LUBRICATION** in **MAINTENANCE AND REPAIR**).

This is not a self-priming pump, so an external priming device must be used if the pump is installed on a **suction lift**. A foot valve may be installed at the end of the suction pipe to maintain the prime; however, this may adversely affect pump performance due to friction loss. Many standard centrifugal models are equipped with a hand-operated vacuum pump, exhaust primer, or ejector for this purpose. If a priming device was not furnished with the pump, it may be ordered from the factory as an option. Before attempting to operate the priming device, close the discharge throttling valve. (Installation of a spring-loaded check valve is also recommended to facilitate priming.) Once the pump is fully primed, close the valve between the priming device and pump to preserve the prime. Start the pump and open the dis-

charge valve slowly to fill the discharge line. When installed in a **flooded suction** application, simply open the system valves and permit the incoming liquid to evacuate the air. After the pump and piping system have completely filled, evacuate any remaining air pockets in the pump or suction line.



NEVER OPERATE THIS PUMP UNLESS THERE IS LIQUID IN THE PUMP CASING. THE PUMP WILL NOT PRIME WHEN DRY. EXTENDED OPERATION OF A DRY PUMP WILL DESTROY THE SEAL ASSEMBLY.

Hand Primers

Hand-operated primers are usually mounted on the pump and, when operated, draw air out of the suction line and pump casing. To prime a pump with a hand vacuum pump, open the cock on the pump priming line. Operate the hand pump until liquid flows out of the check valve on the bottom of the primer pump. Once the pump is primed, close the valve located between the primer and the pump so that the prime will not be lost.

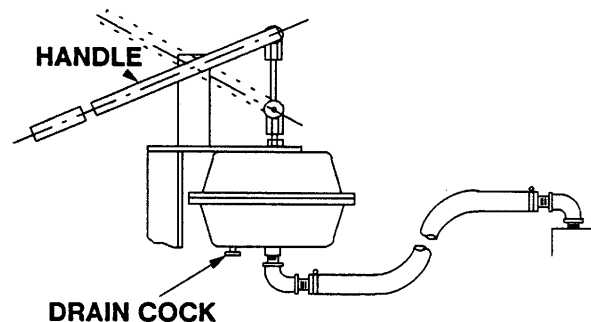

Figure 1. Hand Primer Assembly

Exhaust Primers

Engine driven pumps normally take advantage of the engine exhaust gases by using them to operate an exhaust primer. The exhaust is directed through a venturi which creates a vacuum in the pump casing

in order to fill the suction line and pump casing with liquid. To prime a pump using an exhaust primer, open the gas cock in the priming line and engage the exhaust primer until liquid is thrown out of the ejector nozzle.

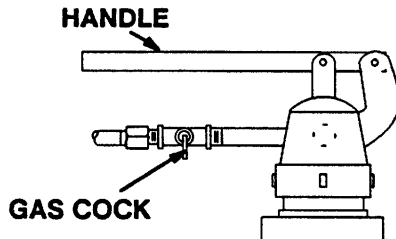

Figure 2. Exhaust Primer Assembly

Air can be exhausted to prime a pump by using a vacuum pump. Either a wet type or a dry type vacuum pump may be used; however, a wet type is preferred since it will not be damaged if liquid enters it. If a dry vacuum pump is used, provisions must be made to keep liquid from entering it.

Auxiliary Ejectors

Ejectors function much like exhaust primers. They may be operated by steam, compressed air, water or exhaust gases. To prime a pump using an ejector, open the gas cock in the priming line and operate the ejector until liquid is thrown out the ejector nozzle.

Vacuum Pumps

Air can be exhausted to prime a pump by using a vacuum pump. Either a wet type or a dry type vacuum pump may be used; however, a wet type is preferred since it will not be damaged if liquid enters it. If a dry vacuum pump is used, provisions must be made to keep liquid from entering it.

STARTING

Consult the operations manual furnished with the power source.

Rotation

The correct direction of pump rotation is counter-clockwise when facing the impeller. If the pump is operated in the wrong direction, pump performance could be adversely affected, and the pump could be seriously damaged.



ONLY OPERATE THIS PUMP IN THE DIRECTION INDICATED BY THE ARROW ON THE PUMP BODY AND ON THE ACCOMPANYING DECAL. OTHERWISE, PUMP PERFORMANCE COULD BE ADVERSELY AFFECTED, AND THE PUMP COULD BE SERIOUSLY DAMAGED.

Consult the operating manual furnished with the power source before attempting to start the power source.

If an electric motor is used to drive the pump, remove V-belts, couplings, or otherwise disconnect the pump from the motor before checking motor rotation. Operate the motor independently while observing the direction of the motor shaft, or cooling fan.

If rotation is incorrect on a three-phase motor, have a qualified electrician interchange any two of the three-phase wires to change direction. If rotation is incorrect on a single-phase motor, consult the literature supplied with the motor for specific instructions.

OPERATION

Leakage

No leakage should be visible at pump mating surfaces, or at pump connections or fittings. Keep all line connections and fittings tight to maintain maximum pump efficiency.

Liquid Temperature And Overheating

The maximum liquid temperature for this pump is 160° F (71,1 °C). Do not apply it at a higher operating temperature.

Overheating can occur if operated with the valves in the suction or discharge lines closed. Operating

against closed valves could bring the liquid to a boil, build pressure, and cause the pump to rupture or explode. If overheating occurs, stop the pump and allow it to cool before servicing it. Refill the pump casing with cool liquid.



ALLOW AN OVER-HEATED PUMP TO COOL BEFORE SERVICING. DO NOT REMOVE PLATES, COVERS, GAUGES, OR FITTINGS FROM AN OVER-HEATED PUMP. LIQUID WITHIN THE PUMP CAN REACH BOILING TEMPERATURES, AND VAPOR PRESSURE WITHIN THE PUMP CAN CAUSE PARTS BEING DISENGAGED TO BE EJECTED WITH GREAT FORCE. AFTER THE PUMP COOLS, DRAIN THE LIQUID FROM THE PUMP BY REMOVING THE CASING DRAIN PLUG. USE CAUTION WHEN REMOVING THE PLUG TO PREVENT INJURY TO PERSONNEL FROM HOT LIQUID.

Strainer Check

If a suction strainer has been shipped with the pump or installed by the user, check the strainer regularly, and clean it as necessary. The strainer should also be checked if pump flow rate begins to drop. If a vacuum suction gauge has been installed, monitor and record the readings regularly to detect strainer blockage.

Never introduce air or steam pressure into the pump casing or piping to remove a blockage. This could result in personal injury or damage to the equipment. If backflushing is absolutely necessary, liquid pressure **must** be limited to 50% of the maximum permissible operating pressure shown on the pump performance curve.

Pump Vacuum Check

Since this pump does not have a suction check valve, the discharge line must be fitted with a check valve if a pump vacuum reading is to be taken.

With the pump inoperative, install a vacuum gauge in the system, using pipe dope on the threads. Block

the suction line and start the pump. At operating speed the pump should pull a vacuum of 20 inches (508,0 mm) or more of mercury. If it does not, check for air leaks in the seal, gasket, or discharge valve.

Open the suction line, and read the vacuum gauge with the pump primed and at operation speed. Shut off the pump. The vacuum gauge reading will immediately drop proportionate to static suction lift, and should then stabilize. If the vacuum reading falls off rapidly after stabilization, an air leak exists. Before checking for the source of the leak, check the point of installation of the vacuum gauge.

STOPPING

Never halt the flow of liquid suddenly. If the liquid being pumped is stopped abruptly, damaging shock waves can be transmitted to the pump and piping system. Close all connecting valves slowly.

On engine driven pumps, reduce the throttle speed slowly and allow the engine to idle briefly before stopping.

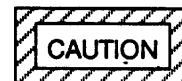

IF THE APPLICATION INVOLVES A HIGH DISCHARGE HEAD, GRADUALLY CLOSE THE DISCHARGE THROTTLING VALVE BEFORE STOPPING THE PUMP.

After stopping the pump, disconnect the power source to ensure that the pump will remain inoperative.

Cold Weather Preservation

In below freezing conditions, drain the pump to prevent damage from freezing. Also, clean out any solids by flushing with a hose. Operate the pump for approximately one minute; this will remove any remaining liquid that could freeze the pump rotating parts. If the pump will be idle for more than a few hours, or if it has been pumping liquids containing a large amount of solids, drain the pump, and flush it thoroughly with clean water. To prevent large solids from clogging the drain port and preventing the pump from completely draining, insert a rod or stiff wire in

the drain port, and agitate the liquid during the draining process. Clean out any remaining solids by flushing with a hose.

BEARING TEMPERATURE CHECK

Bearings normally run at higher than ambient temperatures because of heat generated by friction. Temperatures up to 160°F (71,1°C) are considered normal for bearings, and they can operate safely to at least 180°F (82,2°C).

Checking bearing temperatures by hand is inaccurate. Bearing temperatures can be measured accu-

rately by placing a contact-type thermometer against the housing. Record this temperature for future reference.

A sudden increase in bearing temperature is a warning that the bearings are at the point of failing to operate properly. Make certain that the bearing lubricant is of the proper viscosity and at the correct level (see **LUBRICATION** in **MAINTENANCE AND REPAIR**). Bearing overheating can also be caused by shaft misalignment and/or excessive vibration.

When pumps are first started, the bearings may seem to run at temperatures above normal. Continued operation should bring the temperatures down to normal levels.

TROUBLESHOOTING – SECTION D

Review all WARNINGS in Section A.



BEFORE ATTEMPTING TO OPEN OR SERVICE THE PUMP:

1. FAMILIARIZE YOURSELF WITH THIS MANUAL.
2. DISCONNECT OR LOCK OUT THE POWER SOURCE TO ENSURE THAT THE PUMP WILL REMAIN INOPERATIVE.
3. ALLOW THE PUMP TO COOL IF OVERHEATED.
4. CHECK THE TEMPERATURE BEFORE OPENING ANY COVERS, PLATES, OR PLUGS.
5. CLOSE THE SUCTION AND DISCHARGE VALVES.
6. VENT THE PUMP SLOWLY AND CAUTIOUSLY.
7. DRAIN THE PUMP.

TROUBLE	POSSIBLE CAUSE	PROBABLE REMEDY
<p>PUMP FAILS TO PRIME</p>	<p>Auxiliary priming device faulty or improperly installed.</p> <p>Discharge check valve open.</p> <p>Strainer clogged.</p> <p>Air leak in suction line.</p> <p>Lining of suction hose collapsed.</p> <p>Leaking or worn seal or pump gasket.</p>	<p>Repair priming device or check installation.</p> <p>Check position of handle; close valve.</p> <p>Check strainer and clean if necessary.</p> <p>Correct leak.</p> <p>Replace suction hose.</p> <p>Check pump vacuum. Replace leaking or worn seal or gasket.</p>
<p>PUMP STOPS OR FAILS TO DELIVER RATED FLOW OR PRESSURE</p>	<p>Pump running backwards.</p> <p>Strainer clogged.</p> <p>Air leak in suction line.</p> <p>Suction intake not submerged at proper level or sump too small.</p> <p>Impeller or other wearing parts worn or damaged.</p> <p>Impeller clogged.</p>	<p>Check direction of rotation.</p> <p>Check strainer and clean if necessary.</p> <p>Correct leak.</p> <p>Check installation and correct submergence as needed.</p> <p>Replace worn or damaged parts. Check that impeller is properly centered and rotates freely.</p> <p>Free impeller of debris.</p>

TROUBLE	POSSIBLE CAUSE	PROBABLE REMEDY
PUMP STOPS OR FAILS TO DELIVER RATED FLOW OR PRESSURE (cont.)	<p>Discharge throttling valve partially closed; check that valve is installed improperly.</p> <p>Pump speed too slow.</p> <p>Suction lift too high.</p> <p>Leaking or worn seal or pump gasket.</p> <p>Liquid solution too thick.</p>	<p>Open discharge valve fully; check piping installation.</p> <p>Check driver output; check belts or couplings for slippage.</p> <p>Measure lift w/vacuum gauge. Reduce lift and/or friction losses in suction line.</p> <p>Check pump vacuum. Replace leaking or worn seal or gasket.</p> <p>Dilute if possible.</p>
PUMP REQUIRES TOO MUCH POWER	<p>Power source too small.</p> <p>Pump speed too high.</p> <p>Discharge head too low.</p> <p>Impeller jammed due to debris or insufficient clearance.</p> <p>Liquid solution too thick.</p> <p>Bearing(s) frozen.</p>	<p>Check power requirement for application. Install larger power source.</p> <p>Check driver output; check that sheaves or couplings are correctly sized.</p> <p>Adjust discharge valve.</p> <p>Disassemble pump and check impeller.</p> <p>Dilute if possible.</p> <p>Disassemble pump and check bearing(s).</p>
PUMP CLOGS FREQUENTLY	<p>Discharge flow too slow.</p> <p>Suction check valve or foot valve clogged or binding.</p>	<p>Open discharge valve fully to increase flow rate, and run power source at maximum governed speed.</p> <p>Clean valve.</p>
EXCESSIVE NOISE	<p>Cavitation in pump.</p> <p>Pumping entrained air.</p> <p>Pump or drive not securely mounted.</p> <p>Impeller clogged or damaged.</p> <p>Suction and discharge lines not properly supported.</p>	<p>Reduce suction lift and/or friction losses in suction line. Record vacuum and pressure gauge readings and consult local representative or factory.</p> <p>Locate and eliminate source of air bubble.</p> <p>Secure mounting hardware.</p> <p>Clean out debris; replace damaged parts.</p> <p>Check piping installation for proper support.</p>

TROUBLE	POSSIBLE CAUSE	PROBABLE REMEDY
BEARINGS RUN TOO HOT	Bearing temperature is high, but within limits. Low or incorrect lubricant. Pump speed too high.	Check bearing temperature regularly to monitor any increase. Check for proper type and level of lubricant. Reduce speed of power source.

PUMP MAINTENANCE AND REPAIR - SECTION E

MAINTENANCE AND REPAIR OF THE WEARING PARTS OF THE PUMP WILL MAINTAIN PEAK OPERATING PERFORMANCE.

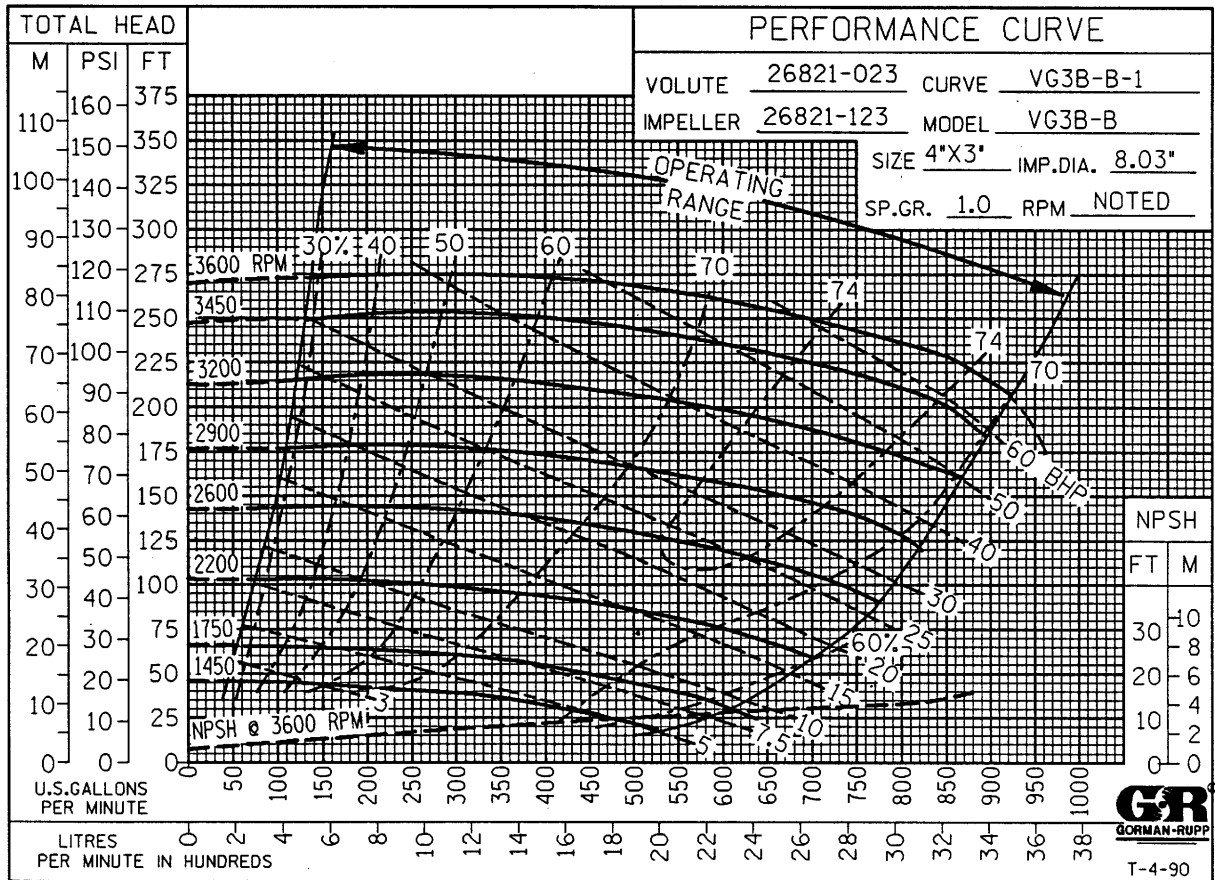

*** STANDARD PERFORMANCE FOR PUMP MODEL VG3B3-B**

* Based on 70° F (21,1°C) clear water at sea level with minimum suction lift. Since pump installations are seldom identical, your performance may be difference due to such factors as viscosity, specific gravity, elevation, temperature, and impeller trim.

Contact the Gorman-Rupp Company to verify performance or part numbers.

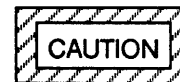

If your pump serial number is followed by an "N", your pump is **NOT** a standard production model.

PUMP SPEED AND OPERATING CONDITION POINTS MUST BE WITHIN THE CONTINUOUS PERFORMANCE RANGE SHOWN ON THE CURVE.

SECTION DRAWING

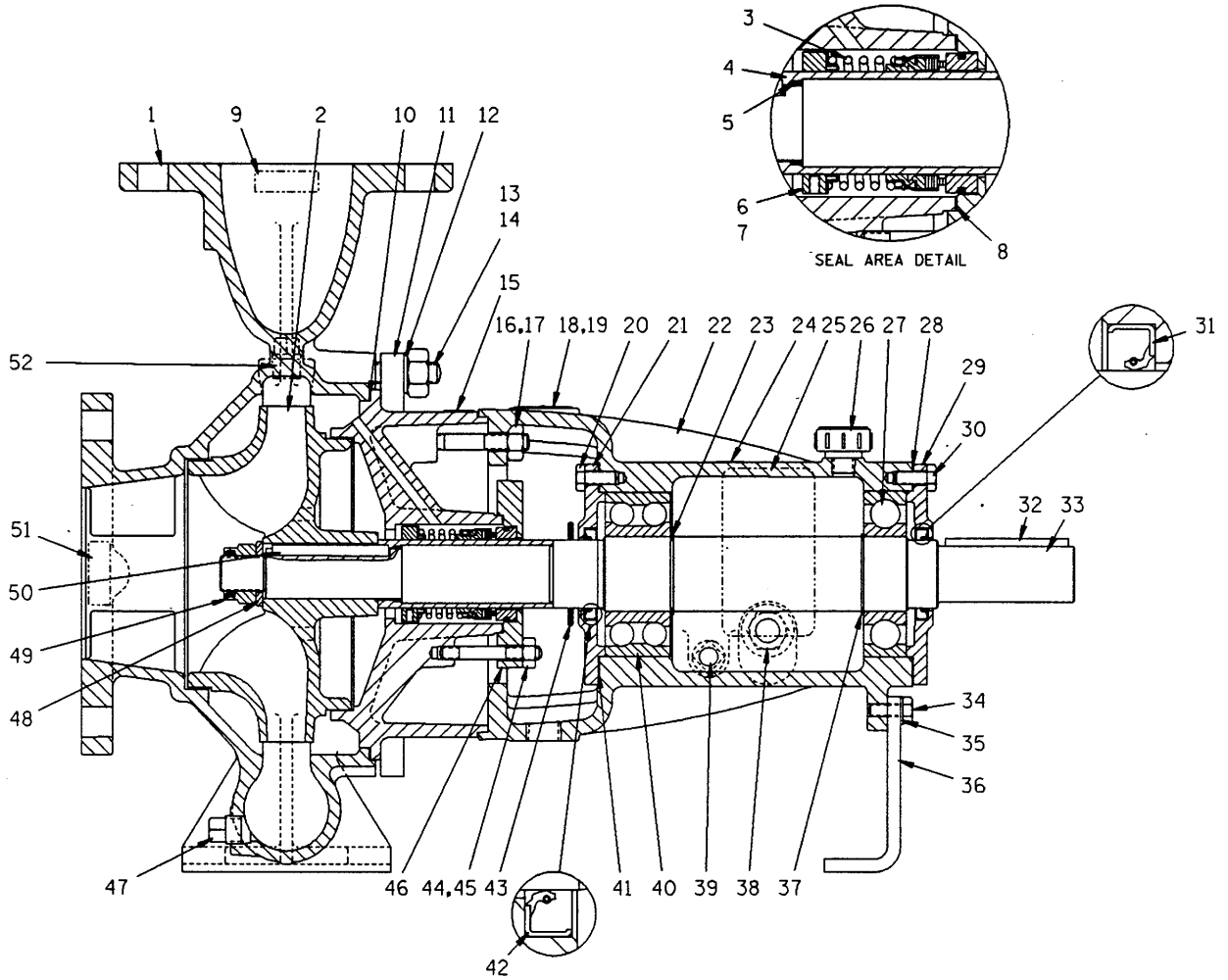

Figure 1. Pump Model VG3B3-B

PARTS LIST
Pump Model VG3B3-B

(From S/N 918585N up)

If your pump serial number is followed by an "N", your pump is NOT a standard production model. Contact the Gorman-Rupp Company to verify part numbers.

ITEM NO.	PART NAME	PART NUMBER	MAT'L CODE	QTY	ITEM NO.	PART NAME	PART NUMBER	MAT'L CODE	QTY
1	PUMP CASING	26821-023	----	1	32 *	SHAFT KEY	N0411	15990	1
2 *	IMPELLER	26821-123	----	1	33	SHAFT	26821-173	----	1
3 *	SEAL ASSY	25271-064	----	1	34	HEX HD CAPSCREW	B0502-1/2	15991	2
4 *	SHAFT SLEEVE	26821-223	----	1	35	WASHER	K05	15991	2
5 *	SLEEVE O-RING	26821-283	----	1	36	FOOT	26821-212	----	1
6	SEAL COLLAR	26821-253	----	1	37	SNAP RING	26821-383	----	1
7	SOC HD SETSCREW	26821-581	----	2	38	OIL SIGHT GAUGE	26821-611	----	1
8 *	SEAL CAP GSKT	26821-461	----	1	39	BRG HSG DRAIN PLUG	26821-502	----	1
9	DISCHARGE STICKER	6588-BJ	----	1	40 *	INBOARD BALL BRG	26821-332	----	1
10 *	PUMP CASING GSKT	26821-430	----	1	41 *	BRG COVER GSKT	26821-403	----	1
11	SEAL PLATE	26821-166	----	1	42 *	OIL SEAL	26821-633	----	1
12	WASHER	K08	15991	6	43	DEFLECTOR	26821-493	----	1
13	STUD	26821-561	----	6	44	STUD	26821-555	----	4
14	HEX NUT	D08	15991	6	45	HEX NUT	D05	15991	4
15	SERIES DECAL	38812-043	----	1	46	SEAL CAP	26821-243	----	1
16	STUD	26821-562	----	4	47	CASING DRAIN PLUG	26821-502	----	1
17	HEX NUT	D08	15991	4	48 *	IMPELLER WASHER	K14	15991	1
18	NAME PLATE	38814-043	13990	1	49 *	IMPELLER NUT	26821-132	----	1
19	DRIVE SCREW	BM#04-03	15990	2	50 *	IMPELLER KEY	26821-263	----	1
20	HEX HD CAPSCREW	B0502-1/2	15991	4	51	SUCTION STICKER	6588-AG	----	1
21	BEARING COVER	26821-073	----	1	52	CASING FILL PLUG	26821-502	----	1
22	BEARING HOUSING	26821-053	----	1					
23	SNAP RING	26821-383	----	1					
24	ROTATION DECAL	2613-M	----	1	OPTIONAL:				
25	LUB DECAL	38816-079	----	1		BRONZE IMPELLER	26821-098	----	1
26	OIL INLET PLUG	26821-616	----	1		VITON SEAL	25271-063	----	1
27 *	OUTBOARD BALL BRG	S1088	----	1		SUCT FLANGE	1756	10010	1
28 *	BRG COVER GSKT	26821-403	----	1		DISCH FLANGE	1753-A	10010	1
29	BEARING COVER	26821-073	----	1		STRAINER	S2003	----	1
30	HEX HD CAPSCREW	B0502-1/2	15991	4		IRRIGATION STRAINER	S1528	----	1
31 *	OIL SEAL	26821-633	----	1		DISCH CHECK VALVE	GRP14-01A	----	1
						HAND PRIMER ASSY	GRP43-02B	----	1

* INDICATES PARTS RECOMMENDED FOR STOCK

Above Serial Numbers Do Not Apply To Pumps Made In Canada.

CANADIAN SERIAL NO. AND UP

PUMP AND SEAL DISASSEMBLY AND REASSEMBLY

Review all warnings in Section A.

Follow the instructions on all tags, label and decals attached to the pump.

This pump requires little service due to its rugged, minimum-maintenance design. However, if it becomes necessary to inspect or replace the wearing parts, follow these instructions which are keyed to the sectional view (see Figure 1) and the accompanying parts list.

Before attempting to service the pump, disconnect or lock out the power source and take precautions to ensure that it will remain inoperative. Close all valves in the suction and discharge lines.

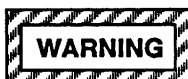

BEFORE ATTEMPTING TO OPEN OR SERVICE THE PUMP:

1. FAMILIARIZE YOURSELF WITH THIS MANUAL.
2. DISCONNECT OR LOCK OUT THE POWER SOURCE TO ENSURE THAT THE PUMP WILL REMAIN INOPERATIVE.
3. ALLOW THE PUMP TO COOL IF OVERHEATED.
4. CHECK THE TEMPERATURE BEFORE OPENING ANY COVERS, PLATES, OR PLUGS.
5. CLOSE THE SUCTION AND DISCHARGE VALVES.
6. VENT THE PUMP SLOWLY AND CAUTIOUSLY.
7. DRAIN THE PUMP.



USE LIFTING AND MOVING EQUIPMENT IN GOOD REPAIR AND WITH ADEQUATE CAPACITY TO PREVENT INJURIES TO PERSONNEL OR DAMAGE TO EQUIPMENT.

Impeller Removal

For access to the impeller (2) or seal assembly (3), the pump casing (1) must be separated from the seal plate (11).

Drain the suction and discharge piping and remove it from the pump. Remove the casing drain plug (47) and drain the pump. Clean and reinstall the drain plug.

Remove the hardware securing the pump casing to the base. Wedge a block of wood under the bearing housing (22) to support the housing when the casing is removed.

Remove the hardware (12 and 14) and separate the pump casing from the seal plate. Tie and tag any leveling shims used under the casing mounting feet. Remove the pump casing gasket (10) and clean the mating surfaces.

Immobilize the shaft (33). Remove the impeller washer and nut (48 and 49) and use a soft-faced mallet to tap the impeller from the shaft. Retain the impeller key (50). Inspect the impeller and replace it if cracked or badly worn.

Seal Removal

To remove the seal assembly (3), disengage the nuts (17) and slide the seal plate (11), seal and shaft sleeve (4) off the shaft as a single unit. Remove the shaft sleeve O-ring (5).

Disengage the nuts (45) and remove the seal cap (46) and gasket (8). Remove the stationary element and O-ring from the seal cap. Pull the sleeve and rotating portion of the seal from the seal plate. Apply oil to the sleeve and work it up under the bellows. Slide the rotating element, retainer and bellows, spring, and spring holder off the sleeve.

NOTE

It is not necessary to remove the seal collar (6) unless the collar or sleeve requires replacement. DO NOT remove the collar until the exact location has been recorded either by scribing or measurement. The location of the collar is critical to pump operation since it establishes the working length of the seal. After the dimension has been recorded, or the location scribed, loosen the setscrews (7) and slide the collar off the sleeve.

If no further disassembly is required, see **Seal Installation**.

Shaft And Bearing Removal And Disassembly

When the pump is properly operated and maintained, the bearing housing should not require disassembly. Disassemble the shaft and bearings **only** when there is evidence of wear or damage.



SHAFT AND BEARING DISASSEMBLY IN THE FIELD IS NOT RECOMMENDED. THESE OPERATIONS SHOULD BE PERFORMED ONLY IN A PROPERLY-EQUIPPED SHOP BY QUALIFIED PERSONNEL.

Separate the power source from the shaft (33) and remove the deflector (43) and key (32).

Remove the hardware securing the foot (36) to the base, and move the bearing housing to a clean, well-equipped shop for disassembly.

Remove the drain plug (39) and drain the bearing housing. Clean and reinstall the drain plug.

Disengage the hardware (20 and 30) and remove the inboard and outboard bearing covers (21 and 29) and gaskets (28 and 41). Inspect the oil seals (31 and 42) and, if replacement is required, use a screwdriver or other suitable tool to pry them from the bearing covers.

Place a block of wood against the drive end of the shaft and tap the shaft and assembled bearings (27 and 40) out of the bearing housing.

After removing the shaft and bearings, clean and inspect the bearings **in place** as follows.



TO PREVENT DAMAGE DURING REMOVAL FROM THE SHAFT, IT IS RECOMMENDED THAT BEARINGS BE CLEANED AND INSPECTED **IN PLACE**. IT IS **STRONGLY** RECOMMENDED THAT THE BEARINGS BE REPLACED **ANY TIME** THE SHAFT AND BEARINGS ARE REMOVED.

Clean the bearing housing, shaft and all component parts (except the bearings) with a soft cloth soaked in cleaning solvent. Inspect the parts for wear or damage and replace as necessary.



MOST CLEANING SOLVENTS ARE TOXIC AND FLAMMABLE. USE THEM ONLY IN A WELL-VENTILATED AREA FREE FROM EXCESSIVE HEAT, SPARKS, AND FLAME. READ AND FOLLOW ALL PRECAUTIONS PRINTED ON SOLVENT CONTAINERS.

Clean the bearings thoroughly in **fresh** cleaning solvent. Dry the bearings with filtered compressed air and coat with light oil.

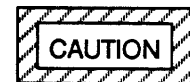

BEARINGS MUST BE KEPT FREE OF ALL DIRT AND FOREIGN MATERIAL. FAILURE TO DO SO WILL GREATLY SHORTEN BEARING LIFE. DO NOT SPIN DRY BEARINGS. THIS MAY SCRATCH THE BALLS OR RACES AND CAUSE PREMATURE BEARING FAILURE.

Rotate the bearings by hand to check for roughness or binding and inspect the bearing balls. If rotation is rough or the bearing balls are discolored, replace the bearings.

The bearing tolerances provide a tight press fit onto the shaft and a snug slip fit into the bearing housing. Replace the bearings, shaft, or bearing housing if the proper bearing fit is not achieved.

Use a bearing puller to remove the inboard and outboard bearings from the shaft.

It is not necessary to remove the bearing snap rings (23 and 37) from the shaft unless replacement is required. If replacement is required, use snap ring pliers to remove the snap rings from the impeller shaft.

Shaft And Bearing Reassembly And Installation

If removed, reinstall the bearing snap rings (23 and 37) in the grooves in the shaft.

Clean and inspect the bearings as indicated in **Shaft and Bearing Removal and Disassembly**.



TO PREVENT DAMAGE DURING REMOVAL FROM THE SHAFT, IT IS RECOMMENDED THAT BEARINGS BE CLEANED AND INSPECTED IN PLACE. IT IS **STRONGLY** RECOMMENDED THAT THE BEARINGS BE REPLACED ANY TIME THE SHAFT AND AND BEARINGS ARE REMOVED.

The bearings may be heated to ease installation. An induction heater, hot oil bath, electric oven, or hot plate may be used to heat the bearings. Bearings should **never** be heated with a direct flame or directly on a hot plate.

NOTE

*If a hot oil bath is used to heat the bearings, both the oil and the container must be **absolutely** clean. If the oil has been previously used, it must be **thoroughly** filtered.*

Heat the bearings to a uniform temperature **no higher than 250°F (120°C)**, and slide the bearings onto the shaft, one at a time, until they are fully seated. This should be done quickly, in one continuous motion, to prevent the bearings from cooling and sticking on the shaft.



USE CAUTION WHEN HANDLING HOT BEARINGS TO PREVENT BURNS.

After the bearings have been installed and allowed to cool, check to ensure that they have not moved out of position in shrinking. If movement has occurred, use a suitable sized sleeve and a press to reposition the bearings.

If heating the bearings is not practical, use a suitable sized sleeve and an arbor (or hydraulic) press to install the bearings on the shaft.



WHEN INSTALLING THE BEARINGS ONTO THE SHAFT, NEVER PRESS OR HIT AGAINST THE OUTER RACE, BALLS, OR BALL CAGE. PRESS ONLY ON THE INNER RACE.

Install the oil seal (31) in the outboard bearing cover (29). Install the gasket (28), and secure the bearing cover to the bearing housing (22) with the capscrews (30).

Slide the shaft and assembled bearings into the bearing housing until the outboard bearing seats against the bearing cover. Be careful not to damage the lip of the oil seal (31) on the shaft keyway.

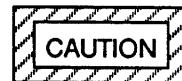

WHEN INSTALLING THE SHAFT AND BEARINGS INTO THE BEARING BORE, PUSH AGAINST THE OUTER RACE. NEVER HIT THE BALLS OR BALL CAGE.

Install the inboard oil seal (42) in the bearing cover (21). Slide the inboard bearing cover and gasket (41) over the shaft and secure them with the capscrews (20). Be careful not to damage the oil seal on the shaft threads.

Install the deflector (43) and shaft key (32).

If removed, secure the foot (36) to the bearing housing with the hardware (34 and 35), and support the bearing housing with a wood block until the pump is fully reassembled. Lubricate the bearings as indicated in **LUBRICATION**.

Seal Reassembly and Installation

Clean the seal cavity and shaft with a cloth soaked in fresh cleaning solvent.



MOST CLEANING SOLVENTS ARE TOXIC AND FLAMMABLE. USE THEM ONLY IN A WELL-VENTILATED AREA FREE FROM EXCESSIVE HEAT, SPARKS, AND FLAME. READ AND FOLLOW ALL PRECAUTIONS PRINTED ON SOLVENT CONTAINERS.

The seal is not normally reused because wear patterns on the finished faces cannot be realigned during reassembly. This could result in premature failure. If necessary to reuse an old seal in an emergency, **carefully** wash all metallic parts in fresh cleaning solvent and allow to dry thoroughly.

Handle the seal parts with extreme care to prevent damage. Be careful not to contaminate precision finished faces; even fingerprints on the faces can

shorten seal life. If necessary, clean the faces with a non-oil based solvent and a clean, lint-free tissue. Wipe **lightly** in a concentric pattern to avoid scratching the faces.

Inspect the seal components for wear, scoring, grooves, and other damage that might cause leakage. Clean and polish the shaft sleeve, or replace it if there are nicks or cuts on either end. If any components are worn, replace the complete seal; **never mix old and new seal parts.**

If a replacement seal is being used, remove it from the container and inspect the precision finished faces to ensure that they are free of any foreign matter.

To ease installation of the seal, lubricate the shaft sleeve, O-rings and bellows with water or a very **small** amount of oil, and apply a drop of light lubricating oil on the finished faces. Assemble the seal as follows, (see Figure 2).

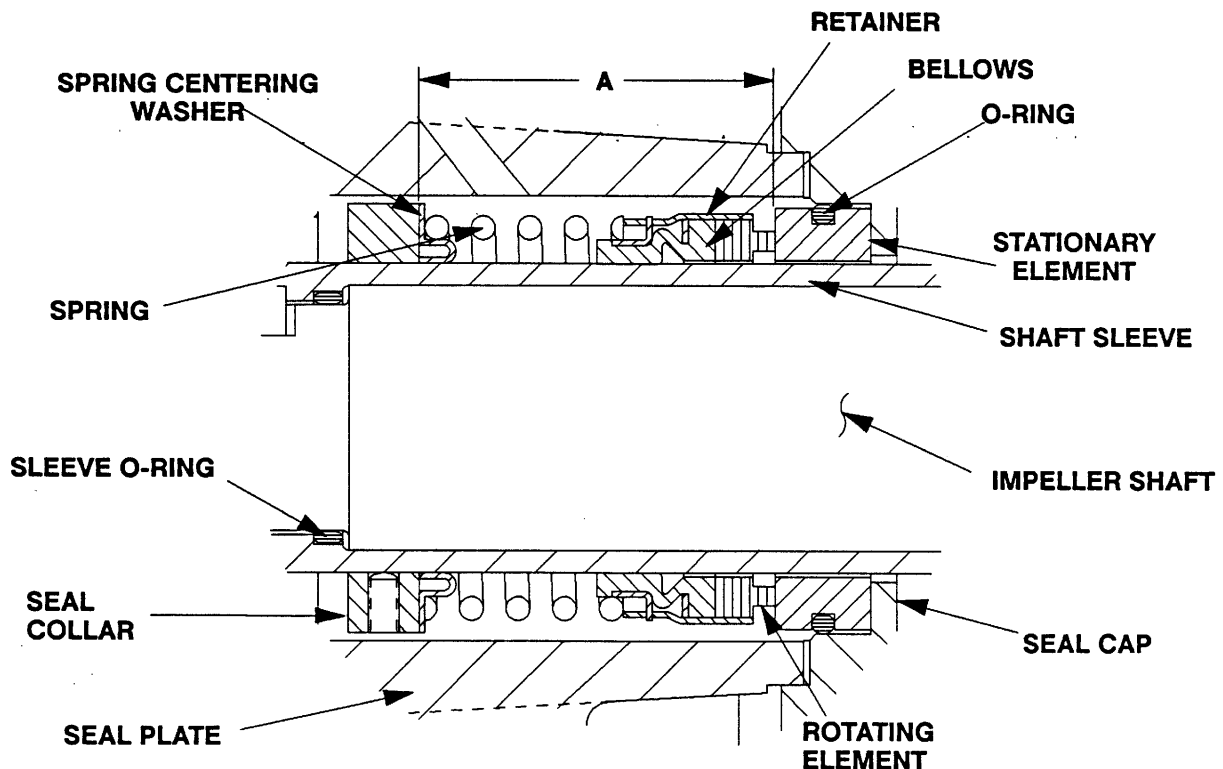
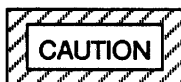

Figure 2. 25271-044 Seal Assembly



THIS SEAL IS NOT DESIGNED FOR OPERATION AT TEMPERATURES ABOVE 160° F (71,1°C). DO NOT USE AT HIGHER OPERATING TEMPERATURES.

Locate the collar (6) on the shaft sleeve at the scribed mark or dimension taken before disassembly, and secure with the setscrews (7).

NOTE

If the dimension is not known, slide the sleeve onto the shaft until fully seated, and scribe the seal working length on the shaft (dimension "A" shown in Figure 2). The stationary element and O-ring must be installed to determine this dimension. The designed working length (from the stationary seal face to the collar) for this seal is 2 inches (50,8 mm). Secure the collar on the sleeve at this point with the setscrews.

Position the seal plate on a flat surface with the impeller side down. Position the sleeve in the seal plate bore with the chamfered end facing up.

Slide the spring holder and spring over the sleeve and against the collar. Assemble the drive grooves of rotating element into the drive lugs of the bellows retainer, and slide this rotating portion of the seal over the sleeve until the retainer seats in the spring.

Use thumb pressure to press the stationary seat and O-ring into the seal cap (46) until fully seated. Slide the assembled stationary seat, seal cap and gasket over the shaft sleeve until the seal faces contact and secure the seal cap and gasket (8) to the seal plate (11) with the nuts (45).

Install the sleeve O-ring (5) completely against the shaft shoulder. Be careful not to cut it on the impeller keyway.

Slide the seal plate, shaft sleeve and seal assembly onto the shaft. Secure the seal plate to the bearing housing with the nuts (17).

Impeller Installation

Inspect the impeller, and replace it if cracked or badly worn. Install the impeller key (50) and slide the impeller onto the shaft and against the sleeve until

both are fully seated. Install the impeller washer and nut (48 and 49).

Install the casing gasket (10). Slide the pump casing (1) over the impeller and secure it to the seal plate with the hardware (12 and 14).

Replace any leveling shims used under the casing mounting feet and install the hardware securing the casing and bearing housing foot to the base. Remove the wood block supporting the bearing housing.

Final Pump Assembly

Be sure the pump is secure to the base and power source.

Install the suction and discharge lines and open all valves. Make certain that all piping connections are tight, properly supported and secure.

Be sure the pump and power source have been properly lubricated, see **LUBRICATION**.

Fill the pump casing with clean liquid. Reinstall the fill plug and tighten it. Refer to **OPERATION**, Section C, before putting the pump back into service.

LUBRICATION

Seal Assembly

The seal assembly is lubricated by the medium being pumped and no additional lubrication is required.

Bearings

The bearing housing was fully lubricated when shipped from the factory. Check the oil level regularly through the sight gauge (38) and maintain it at the middle of the gauge. When lubrication is required, add SAE No. 30 non-detergent-oil through the oil inlet plug opening (26). **Do not** over-lubricate. Over-lubrication can cause the bearings to overheat, resulting in premature bearing failure.

Under normal conditions, drain the bearing housing once each year and refill with clean oil. Change the oil more frequently if the pump is operated continu-

ously or installed in an environment with rapid temperature change.

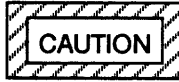

MONITOR THE CONDITION OF THE BEARING LUBRICANT REGULARLY FOR EVIDENCE OF RUST OR MOISTURE CONDENSATION. THIS IS ESPE-

CIALLY IMPORTANT IN AREAS WHERE VARIABLE HOT AND COLD TEMPERATURES ARE COMMON.

For cold weather operation, consult the factory or a lubricant supplier for the recommended grade of oil.

Power Source

Consult the literature supplied with the power source, or contact your local power source representative.

**For U.S. and International Warranty Information,
Please Visit www.grpumps.com/warranty
or call:
U.S.: 419-755-1280
International: +1-419-755-1352**

**For Canadian Warranty Information,
Please Visit www.grcanada.com/warranty
or call:
519-631-2870**