**INSTALLATION, OPERATION,
AND MAINTENANCE MANUAL**
WITH PARTS LIST



MODEL
11 1/2A52-E2 1P
11 1/2A52-E2 3P

THE GORMAN-RUPP COMPANY • MANSFIELD, OHIO

GORMAN-RUPP OF CANADA LIMITED • ST. THOMAS, ONTARIO, CANADA Printed in U.S.A.

©Copyright by the Gorman-Rupp Company

TABLE OF CONTENTS

INTRODUCTION	PAGE I – 1
SAFETY - SECTION A	PAGE A – 1
INSTALLATION – SECTION B	PAGE B – 1
Pump Dimensions	PAGE B – 1
PREINSTALLATION INSPECTION	PAGE B – 1
POSITIONING PUMP	PAGE B – 2
Lifting	PAGE B – 2
Mounting	PAGE B – 2
Clearance	PAGE B – 2
SUCTION AND DISCHARGE PIPING	PAGE B – 2
Materials	PAGE B – 2
Line Configuration	PAGE B – 3
Connections to Pump	PAGE B – 3
Gauges	PAGE B – 3
SUCTION LINES	PAGE B – 3
Fittings	PAGE B – 3
Strainers	PAGE B – 3
Sealing	PAGE B – 3
Suction Lines In Sumps	PAGE B – 3
Suction Line Positioning	PAGE B – 4
DISCHARGE LINES	PAGE B – 4
Siphoning	PAGE B – 4
Valves	PAGE B – 4
Bypass Lines	PAGE B – 5
ELECTRICAL CONNECTIONS	PAGE B – 5
OPERATION – SECTION C	PAGE C – 1
PRIMING	PAGE C – 1
STARTING	PAGE C – 1
Rotation	PAGE C – 1
OPERATION	PAGE C – 2
Lines With a Bypass	PAGE C – 2
Lines Without a Bypass	PAGE C – 2
Leakage	PAGE C – 2
Liquid Temperature And Overheating	PAGE C – 2
Strainer Check	PAGE C – 2
Pump Vacuum Check	PAGE C – 2
STOPPING	PAGE C – 3
Cold Weather Preservation	PAGE C – 3
TROUBLESHOOTING – SECTION D	PAGE D – 1
PUMP MAINTENANCE AND REPAIR - SECTION E	PAGE E – 1
STANDARD PERFORMANCE CURVE	PAGE E – 1

TABLE OF CONTENTS
(continued)

PARTS LIST:	
Pump Model	PAGE E – 3
PUMP AND SEAL DISASSEMBLY AND REASSEMBLY	PAGE E – 4
Suction Check Valve Removal and Disassembly	PAGE E – 4
Back Cover Removal	PAGE E – 4
Pump Casing Removal	PAGE E – 5
Impeller Removal	PAGE E – 5
Seal Removal and Disassembly	PAGE E – 5
Seal Reassembly and Installation	PAGE E – 5
Impeller Installation And Adjustment	PAGE E – 6
Pump Casing Installation	PAGE E – 6
Back Cover Installation	PAGE E – 7
Suction Check Valve Installation	PAGE E – 7
Final Pump Assembly	PAGE E – 7
LUBRICATION	PAGE E – 7
Seal Assembly	PAGE E – 7
Motor	PAGE E – 7

INTRODUCTION

This Installation, Operation, and Maintenance manual is designed to help you achieve the best performance and longest life from your Gorman-Rupp pump.

This pump is a 10 Series, semi-open impeller, self-priming centrifugal model with a suction check valve. It is close-coupled to a 2 H.P., single phase or

three phase, totally enclosed fan-cooled electric motor. The basic material of construction for wetted parts is gray iron, with steel wearing parts and stainless steel motor shaft. The pump is designed for handling most non-volatile, nonflammable liquids containing specified entrained solids.

For information or technical assistance on the motor, contact the motor manufacturer's local dealer or representative.

If there are any questions regarding the pump or its application which are not covered in this manual or in other literature accompanying this unit, please contact your Gorman-Rupp distributor, or write:

The Gorman-Rupp Company
P.O. Box 1217
Mansfield, Ohio 44901-1217

or Gorman-Rupp of Canada Limited
70 Burwell Road
St. Thomas, Ontario N5P 3R7

The following are used to alert maintenance personnel to procedures which require special attention, to those which could damage equipment, and to those which could be dangerous to personnel:



Immediate hazards which WILL result in severe personal injury or death. These instructions describe the procedure required and the injury which will result from failure to follow the procedure.

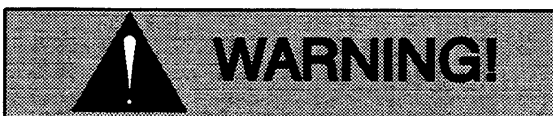

Hazards or unsafe practices which COULD result in severe personal injury or death. These instructions describe the procedure required and the injury which could result from failure to follow the procedure.



Hazards or unsafe practices which COULD result in minor personal injury or product or property damage. These instructions describe the requirements and the possible damage which could result from failure to follow the procedure.

NOTE

Instructions to aid in installation, operation, and maintenance or which clarify a procedure.

SAFETY - SECTION A

This information applies to 10 Series motor driven pumps. Refer to the manual accompanying the motor before attempting to begin operation.

Because pump installations are seldom identical, this manual cannot possibly provide detailed instructions and precautions for each specific application. Therefore, it is the owner/installer's responsibility to ensure that applications not addressed in this manual are performed only after establishing that neither operator safety nor pump integrity are compromised by the installation.

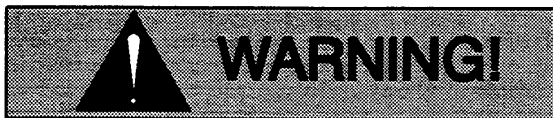

Before attempting to open or service the pump:

1. Familiarize yourself with this manual.
2. Disconnect the incoming power to the motor and lock it out to ensure that the pump will remain inoperative.
3. Allow the pump to completely cool if overheated.
4. Check the temperature before opening any covers, plates, or plugs.
5. Close the suction and discharge valves.
6. Vent the pump slowly and cautiously.
7. Drain the pump.

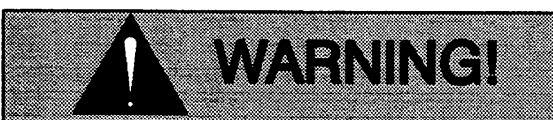

This pump is designed to handle most non-volatile, non-flammable liquids

containing specified entrained solids. Do not attempt to pump volatile, corrosive, or flammable liquids which may damage the pump or endanger personnel as a result of pump failure.

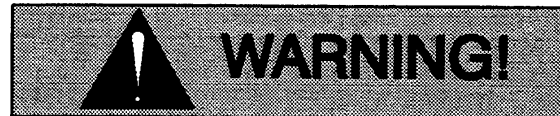

After the pump has been installed, make certain that the pump and all piping or hose connections are tight, properly supported and secure before operation.

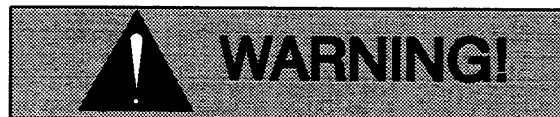

Do not operate the pump against a closed discharge valve for long periods of time. If operated against a closed discharge valve, pump components will deteriorate, and the liquid could come to a boil, build pressure, and cause the pump casing to rupture or explode.

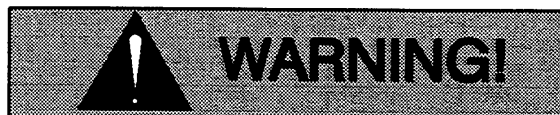

Do not remove plates, covers, gauges, pipe plugs, or fittings from an overheated pump. Vapor pressure within the pump can cause parts being disengaged to be ejected with great force. Allow the pump to cool before servicing.



Do not install and operate a non-explosion proof motor in an explosive atmosphere. Install, connect, and operate the motor in accordance with the National Electric Code and all local codes. If there is a conflict between the instructions in the manual accompanying the unit and the National Electric Code or

the applicable local code, the National or local code shall take precedence.



The electrical power used to operate this pump is high enough to cause injury or death. Obtain the services of a qualified electrician to troubleshoot, test

and/or service the electrical components of this pump.

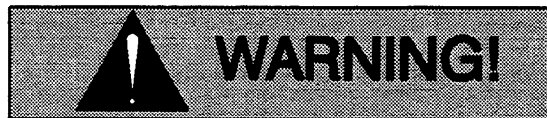

Never run this pump backwards. Be certain that rotation is correct before fully engaging the pump.

INSTALLATION – SECTION B

Review all SAFETY information in Section A.

Since pump installations are seldom identical, this section offers only general recommendations and practices required to inspect, position, and arrange the pump and piping.

Most of the information pertains to a standard **static lift** application where the pump is positioned above the free level of liquid to be pumped.

If installed in a **flooded suction** application where the liquid is supplied to the pump under pressure, some of the information such as mounting, line configuration, and priming must be tailored to the

specific application. Since the pressure supplied to the pump is critical to performance and safety, **be sure to limit the incoming pressure to 50% of the maximum permissible operating pressure as shown on the pump performance curve (see Section E, Page 1).**

For further assistance, contact your Gorman-Rupp distributor or the Gorman-Rupp Company.

Pump Dimensions

See Figure 1 for the approximate physical dimensions of this pump.

OUTLINE DRAWING

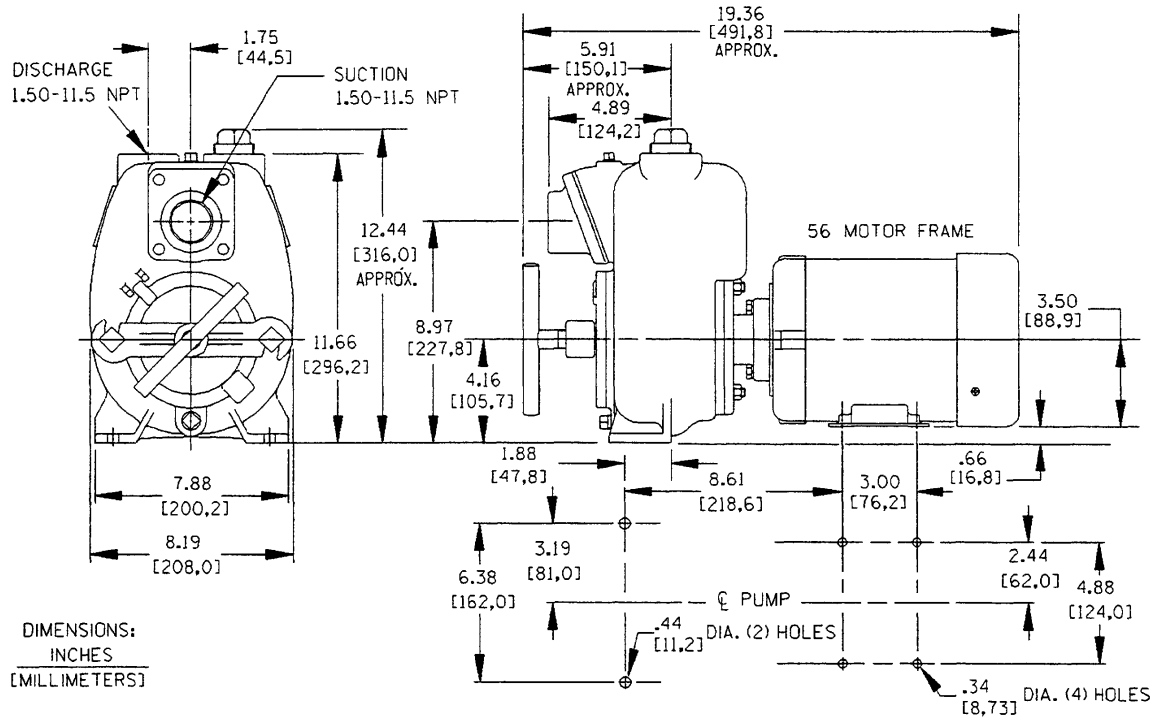

Figure 1. Pump Model 11 1/2A52-E2 1P and 11 1/2A52-E2 3P

PREINSTALLATION INSPECTION

The pump assembly was inspected and tested before shipment from the factory. Before installation, inspect the pump for damage which may have occurred during shipment. Check as follows:

- a. Inspect the pump and motor for cracks, dents, damaged threads, and other obvious damage.
- b. Check for and tighten loose attaching hardware. Since gaskets tend to shrink after dry-

ing, check for loose hardware at mating surfaces.

- c. Carefully read all tags, decals, and markings on the pump assembly, and perform all duties indicated. Note that the pump shaft rotates in the required direction.



The impeller of the pump is threaded onto the pump shaft. Reverse rotation of the shaft can cause the impeller to unscrew and break the suction head or casing. Disconnect the power before checking for proper direction of rotation.

- d. Check levels and lubricate as necessary. Refer to **LUBRICATION** in the **MAINTENANCE AND REPAIR** section of this manual and perform duties as instructed.
- e. If the pump and motor have been stored for more than 12 months, some of the components or lubricants may have exceeded their maximum shelf life. These **must be inspected or replaced** to ensure maximum pump service.



The electrical power used to operate this pump is high enough to cause injury or death. Obtain the services of a qualified electrician to troubleshoot, test and/or service the electrical components of this pump.

If the maximum shelf life has been exceeded, or if anything appears to be abnormal, contact your Gorman-Rupp distributor or the factory to determine the repair or updating policy. **Do not** put the pump into service until appropriate action has been taken.

POSITIONING PUMP

Lifting

Use lifting equipment with a capacity of at least **500 pounds (227 kg)**. This pump weighs approximately **96 pounds (44 kg)**, not including the weight of accessories or optional equipment. Customer-installed equipment such as suction and discharge piping **must** be removed before attempting to lift.



The pump assembly can be seriously damaged if the chains or cables used to lift and move the unit are improperly wrapped around the pump.

Mounting

Locate the pump in an accessible place as close as practical to the liquid being pumped. Level mounting is essential for proper operation.

The pump may have to be supported or shimmed to provide for level operation or to eliminate vibration.

Clearance

A minimum clearance of **18 inches** in front of the cover plate is required to permit removal of the cover and easy access to the pump interior.

SUCTION AND DISCHARGE PIPING

Pump performance is adversely effected by increased suction lift, discharge elevation, and friction losses. See the performance curve on Page E-1 to be sure your overall application allows pump to operate within the safe operation range.

Materials

Either pipe or hose maybe used for suction and discharge lines; however, the materials must be compatible with the liquid being pumped. If hose is used in suction lines, it must be the rigid-wall, rein-

forced type to prevent collapse under suction. Using piping couplings in suction lines is not recommended.

Line Configuration

Keep suction and discharge lines as straight as possible to minimize friction losses. Make minimum use of elbows and fittings, which substantially increase friction loss. If elbows are necessary, use the long-radius type to minimize friction loss.

Connections to Pump

Before tightening a connecting flange, align it exactly with the pump port. Never pull a pipe line into place by tightening the flange bolts and/or couplings.

Lines near the pump must be independently supported to avoid strain on the pump which could cause excessive vibration, decreased bearing life, and increased shaft and seal wear. If hose-type lines are used, they should have adequate support to secure them when filled with liquid and under pressure.

Gauges

Most pumps are drilled and tapped for installing discharge pressure and vacuum suction gauges. If these gauges are desired for pumps that are not tapped, drill and tap the suction and discharge lines not less than 18 inches (457,2 mm) from the suction and discharge ports and install the lines. Installation closer to the pump may result in erratic readings.

SUCTION LINES

To avoid air pockets which could affect pump priming, the suction line must be as short and direct as possible. When operation involves a suction lift, the line must always slope upward to the pump from the source of the liquid being pumped; if the line slopes down to the pump at any point along the suction run, air pockets will be created.

Fittings

Suction lines should be the same size as the pump inlet. If reducers are used in suction lines, they should be the eccentric type, and should be installed with the flat part of the reducers uppermost to avoid creating air pockets. Valves are not normally used in suction lines, but if a valve is used, install it with the stem horizontal to avoid air pockets.

Strainers

If a strainer is furnished with the pump, be certain to use it; any spherical solids which pass through a strainer furnished with the pump will also pass through the pump itself.

If a strainer is not furnished with the pump, but is installed by the pump user, make certain that the total area of the openings in the strainer is at least three or four times the cross section of the suction line, and that the openings will not permit passage of solids larger than the solids handling capability of the pump.

This pump is designed to handle up to 1 inch (25,4 mm) diameter spherical solids.

Sealing

Since even a slight leak will affect priming, head, and capacity, especially when operating with a high suction lift, all connections in the suction line should be sealed with pipe dope to ensure an airtight seal. Follow the sealant manufacturer's recommendations when selecting and applying the pipe dope. The pipe dope should be compatible with the liquid being pumped.

Suction Lines In Sumps

If a single suction line is installed in a sump, it should be positioned away from the wall of the sump at a distance equal to 1-1/2 times the diameter of the suction line

If there is a liquid flow from an open pipe into the sump, the flow should be kept away from the suction inlet because the inflow will carry air down into the sump, and air entering the suction line will reduce pump efficiency.

If it is necessary to position inflow close to the suction inlet, install a baffle between the inflow and the suction inlet at a distance 1-1/2 times the diameter of the suction pipe. The baffle will allow entrained air to escape from the liquid before it is drawn into the suction inlet.

If two suction lines are installed in a single sump, the flow paths may interact, reducing the efficiency of one or both pumps. To avoid this, position the suction inlets so that they are separated by a distance equal to at least 3 times the diameter of the suction pipe.

Suction Line Positioning

The depth of submergence of the suction line is critical to efficient pump operation. Figure 2 shows recommended minimum submergence vs. velocity.

NOTE

The pipe submergence required may be reduced by installing a standard pipe increaser fitting at the end of the suction line. The larger opening size will reduce the inlet velocity. Calculate the required submergence using the following formula based on the increased opening size (area or diameter).

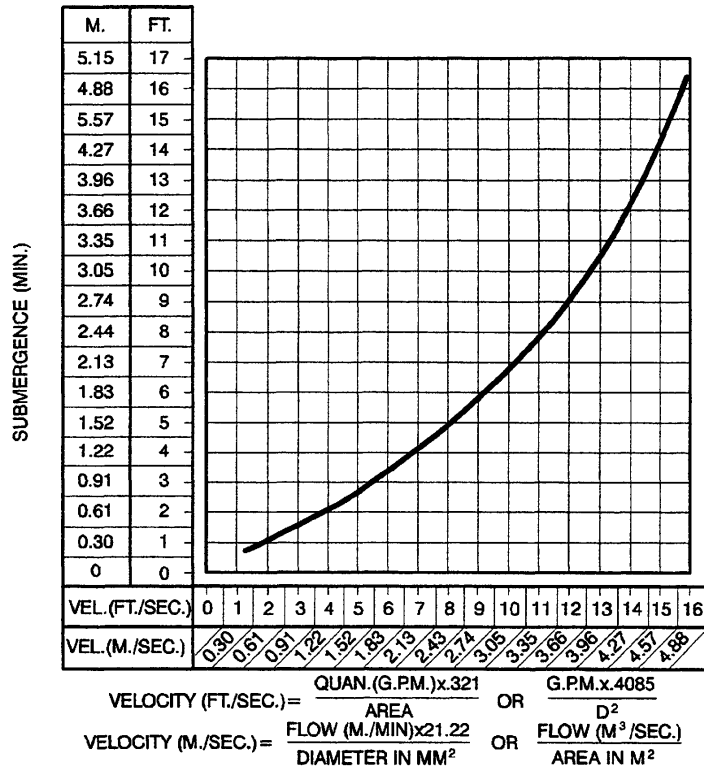

Figure 2. Recommended Minimum Suction Line Submergence vs. Velocity

DISCHARGE LINES

Siphoning

Do not terminate the discharge line at a level lower than that of the liquid being pumped unless a siphon breaker is used in the line. Otherwise, a siphoning action causing damage to the pump could result.

Valves

If a throttling valve is desired in the discharge line, use a valve as large as the largest pipe to minimize friction losses. Never install a throttling valve in a suction line.

A check valve in the discharge line is normally recommended, but it is not necessary in low discharge head applications.

With high discharge heads, it is recommended that a throttling valve and a system check valve be installed in the discharge line to protect the pump from excessive shock pressure and reverse rotation when it is stopped.



If the application involves a high discharge head, gradually close the discharge throttling valve before stopping the pump.

Bypass Lines

If a system check valve is used due to high discharge head, it may be necessary to vent trapped air from the top of the pump during the priming process. This may be accomplished by installing a bypass line from the top of the pump, back to the source of liquid. The end of the bypass line must be submerged. The line must be large enough to prevent clogging, but not so large as to affect pump discharge capacity.

ELECTRICAL CONNECTIONS

Before connecting the motor to the incoming power, check that the electrical service available

matches the pump motor requirements stamped on the motor nameplate.



The electrical power used to operate this pump is high enough to cause injury or death. Obtain the services of a qualified electrician to make all electrical connections.

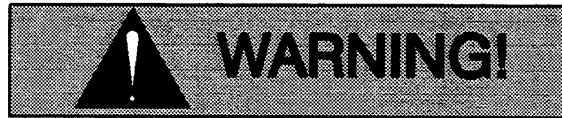

Do not install and operate a non-explosion proof motor in an explosive atmosphere. Install, connect, and operate the motor in accordance with The National Electric Code and all local codes. If there is a conflict between the instructions in the manual accompanying the unit and The National Electric Code or the applicable local code, The National or local code shall take precedence.

Refer to the following motor data before making electrical connections.

VOLTAGE	PHASE	HP	Hz	RPM	THERMAL OVERLOAD
115/230	1	2	60	3450	N/A
208/230/460	3	2	60	3450	N/A

OPERATION – SECTION C

Review all SAFETY information in Section A.

Follow the instructions on all tags, labels and decals attached to the pump.



This pump is designed to handle most non-volatile, non-flammable liquids containing specified entrained solids. Do not attempt to pump volatile, corrosive, or flammable liquids which may damage the pump or endanger personnel as a result of pump failure.

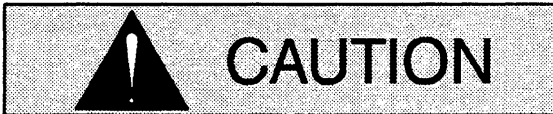

Pump speed and operating condition points must be within the continuous performance range shown on the curve (see Section E, Page 1).

PRIMING

Install the pump and piping as described in **INSTALLATION**. Make sure that the piping connections are tight, and that the pump is securely mounted. Check that the pump is properly lubricated (see **LUBRICATION** in **MAINTENANCE AND REPAIR**).

This pump is self-priming, but the pump should never be operated unless there is liquid in the pump casing.

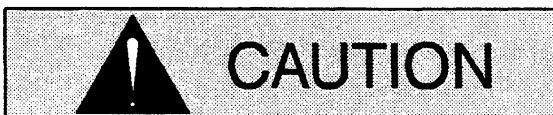

Never operate this pump unless there is liquid in the pump casing. The pump will not prime when dry. Extended operation of a dry pump will destroy the seal assembly.

Add liquid to the pump casing when:

1. The pump is being put into service for the first time.
2. The pump has not been used for a considerable length of time.
3. The liquid in the pump casing has evaporated.

Once the pump casing has been filled, the pump will prime and reprime as necessary.

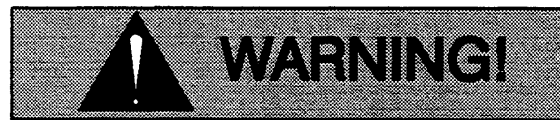

After filling the pump casing, reinstall and tighten the fill plug. Do not attempt to operate the pump unless all connecting piping is securely installed. Otherwise, liquid in the pump forced out under pressure could cause injury to personnel.

To fill the pump, remove the pump casing fill cover or fill plug in the top of the casing, and add clean liquid until the casing is filled. Replace the fill cover or fill plug before operating the pump.

STARTING

Consult the operations manual furnished with the motor.

Rotation

The correct direction of pump rotation is indicated by an arrow on the pump body or accompanying decals. If the pump is operated in the wrong direction, the impeller could become loosened from the shaft and seriously damage the pump.



The pump must operate in the direction indicated by the arrow on the pump, or accompanying decals. Reverse rotation could loosen the impeller and seriously damage the pump.

Consult the operating manual furnished with the pump motor before attempting to start the motor.

If rotation is incorrect on a three-phase motor, have a qualified electrician interchange any two of the three phase wires to change direction. If rotation is incorrect on a single-phase motor, consult the literature supplied with the motor for specific instructions.

OPERATION

Lines With a Bypass

Close the discharge throttling valve (if so equipped) so that the pump will not have to prime against the weight of the liquid in the discharge line. Air from the suction line will be discharged through the bypass line back to the wet well during the priming cycle. When the pump is fully primed and liquid is flowing steadily from the bypass line, open the discharge throttling valve. Liquid will then continue to circulate through the bypass line while the pump is in operation.

Lines Without a Bypass

Open all valves in the discharge line and start the motor. Priming is indicated by a positive reading on the discharge pressure gauge or by a quieter operation. The pump may not prime immediately because the suction line must first fill with liquid. If the pump fails to prime within five minutes, stop it and check the suction line for leaks.

After the pump has been primed, partially close the discharge line throttling valve in order to fill the line slowly and guard against excessive shock pressure which could damage pipe ends, gaskets, sprinkler heads, and any other fixtures connected to the line. When the discharge line is completely filled, adjust the throttling valve to the required flow rate.

Leakage

No leakage should be visible at pump mating surfaces, or at pump connections or fittings. Keep all line connections and fittings tight to maintain maximum pump efficiency.

Liquid Temperature And Overheating

The **maximum** liquid temperature for this pump is 160° F (71°C). Do not apply it at a higher operating temperature.

Overheating can occur if operated with the valves in the suction or discharge lines closed. Operating against closed valves could bring the liquid to a boil, build pressure, and cause the pump to rupture or explode. If overheating occurs, stop the pump and allow it to cool before servicing it. Refill the pump casing with cool liquid.

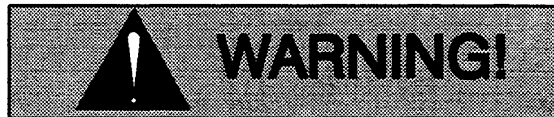

Do not remove plates, covers, gauges, pipe plugs, or fittings from an overheated pump. Vapor pressure within the pump can cause parts being disengaged to be ejected with great force. Allow the pump to cool before servicing.

Strainer Check

If a suction strainer has been shipped with the pump or installed by the user, check the strainer regularly, and clean it as necessary. The strainer should also be checked if pump flow rate begins to drop. If a vacuum suction gauge has been installed, monitor and record the readings regularly to detect strainer blockage.

Never introduce air or steam pressure into the pump casing or piping to remove a blockage. This could result in personal injury or damage to the equipment. If backflushing is absolutely necessary, **liquid pressure** must be limited to 50% of the maximum permissible operating pressure shown on the pump performance curve (see Section E, Page 1).

Pump Vacuum Check

With the pump inoperative, install a vacuum gauge in the system, using pipe dope on the threads. Block the suction line and start the pump. At operating speed the pump should pull a vacuum of 20 inches (508 mm) or more of mercury. If it does not, check for air leaks in the seal, gasket, or discharge valve.

Open the suction line, and read the vacuum gauge with the pump primed and at operation speed. Shut off the pump. The vacuum gauge reading will immediately drop proportionate to static suction lift, and should then stabilize. If the vacuum reading falls off rapidly after stabilization, an air leak exists. Before checking for the source of the leak, check the point of installation of the vacuum gauge.

STOPPING

Never halt the flow of liquid suddenly. If the liquid being pumped is stopped abruptly, damaging shock waves can be transmitted to the pump and piping system. Close all connecting valves slowly.



If the application involves a high discharge

head, gradually close the discharge throttling valve before stopping the pump.

After stopping the pump, disconnect the incoming power to the motor and lock it out to ensure that the pump will remain inoperative.

Cold Weather Preservation

In below freezing conditions, drain the pump to prevent damage from freezing. Also, clean out any solids by flushing with a hose. Operate the pump for approximately one minute; this will remove any remaining liquid that could freeze the pump rotating parts. If the pump will be idle for more than a few hours, or if it has been pumping liquids containing a large amount of solids, drain the pump, and flush it thoroughly with clean water. To prevent large solids from clogging the drain port and preventing the pump from completely draining, insert a rod or stiff wire in the drain port, and agitate the liquid during the draining process. Clean out any remaining solids by flushing with a hose.

TROUBLESHOOTING – SECTION D

Review all SAFETY information in Section A.

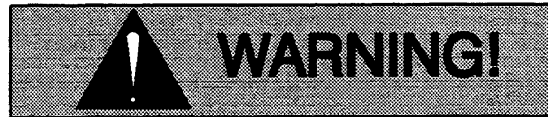

Before attempting to open or service the pump:

1. Familiarize yourself with this manual.
2. Disconnect the incoming power to the motor and lock it out to ensure that the pump will remain inoperative.
3. Allow the pump to completely cool if overheated.
4. Check the temperature before opening any covers, plates, or plugs.
5. Close the suction and discharge valves.
6. Vent the pump slowly and cautiously.
7. Drain the pump.

TROUBLE	POSSIBLE CAUSE	PROBABLE REMEDY
PUMP FAILS TO PRIME	Not enough liquid in casing. Suction check valve contaminated or damaged. Air leak in suction line. Lining of suction hose collapsed. Leaking or worn seal or pump gasket. Suction lift or discharge head too high. Strainer clogged.	Add liquid to casing. See PRIMING . Clean or replace check valve. Correct leak. Replace suction hose. Check pump vacuum. Replace leaking or worn seal or gasket. Check piping installation and install bypass line if needed. See INSTALLATION . Check strainer and clean if necessary.
PUMP STOPS OR FAILS TO DELIVER RATED FLOW OR PRESSURE	Air leak in suction line. Lining of suction hose collapsed. Suction intake not submerged at proper level or sump too small. Impeller or other wearing parts worn or damaged.	Correct leak. Replace suction hose. Check installation and correct submergence as needed. Replace worn or damaged parts. Check that impeller is properly centered and rotates freely.

TROUBLE	POSSIBLE CAUSE	PROBABLE REMEDY
PUMP STOPS OR FAILS TO DELIVER RATED FLOW OR PRESSURE (cont.)	<p>Leaking or worn seal or pump gasket.</p> <p>Impeller clogged.</p> <p>Low or incorrect voltage.</p> <p>No voltage at line side of circuit breaker.</p> <p>Pump running backwards.</p> <p>Suction lift or discharge head too high.</p>	<p>Check pump vacuum. Replace leaking or worn seal or gasket.</p> <p>Free impeller of debris.</p> <p>Measure control box voltage, both when pump is running and when shut off.</p> <p>Check power source for blown fuse, open circuit breaker or control box, broken lead, or loose connection.</p> <p>Check direction of rotation and correct by interchanging any two motor leads at control box. (See Pump Rotation, Section C).</p> <p>Check piping installation and install bypass line if needed. See INSTALLATION.</p>
PUMP REQUIRES TOO MUCH POWER	<p>Motor shaft or bearings defective.</p> <p>Discharge head too low.</p> <p>Liquid solution too thick.</p>	<p>Disassemble pump and check motor and bearings.</p> <p>Adjust discharge valve.</p> <p>Dilute if possible.</p>
PUMP CLOGS FREQUENTLY	<p>Discharge flow too slow.</p> <p>Suction check valve or foot valve clogged or binding.</p>	<p>Open discharge valve fully to increase flow rate, and run motor at maximum governed speed.</p> <p>Clean valve.</p>
EXCESSIVE NOISE	<p>Cavitation in pump.</p> <p>Pumping entrained air.</p> <p>Pump or drive not securely mounted.</p> <p>Impeller clogged or damaged.</p>	<p>Reduce suction lift and/or friction losses in suction line. Record vacuum and pressure gauge readings and consult local representative or factory.</p> <p>Locate and eliminate source of air bubble.</p> <p>Secure mounting hardware.</p> <p>Clean out debris; replace damaged parts.</p>

PUMP MAINTENANCE AND REPAIR - SECTION E

MAINTENANCE AND REPAIR OF THE WEARING PARTS OF THE PUMP WILL MAINTAIN PEAK OPERATING PERFORMANCE.

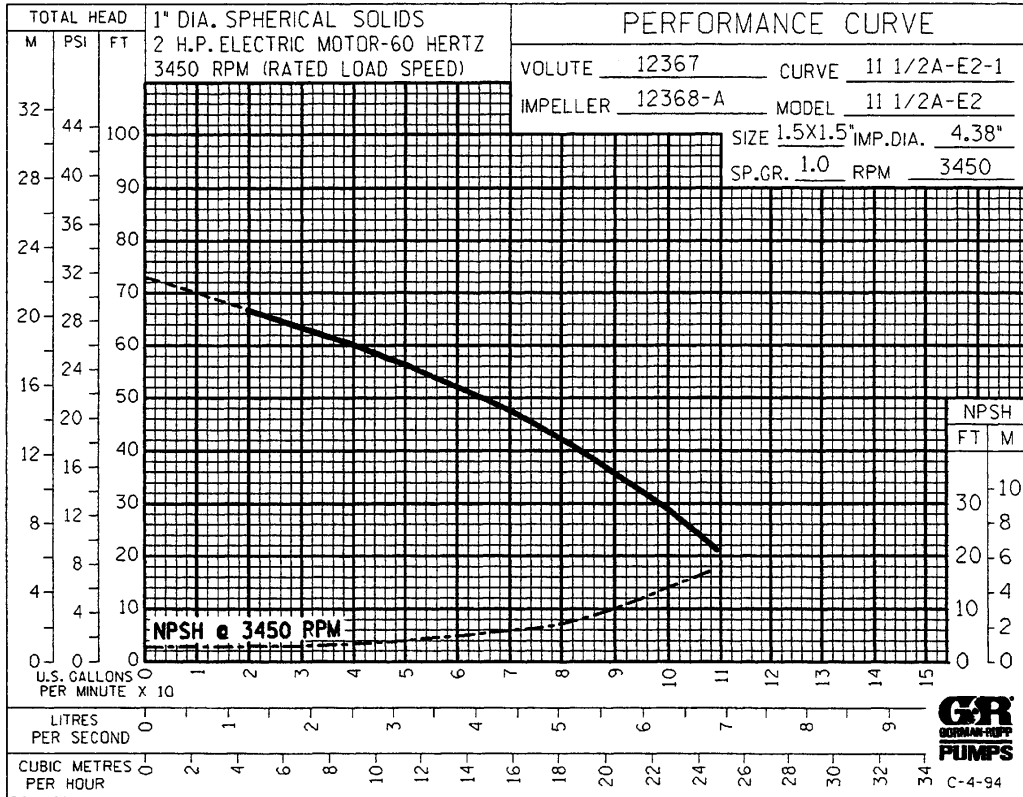

*** STANDARD PERFORMANCE FOR PUMP MODEL 11 1/2A52-E2 3P**

* Based on 70° F (21° C) clear water at sea level with minimum suction lift. Since pump installations are seldom identical, your performance may be different due to such factors as viscosity, specific gravity, elevation, temperature, and impeller trim.

Contact the Gorman-Rupp Company to verify performance or part numbers.

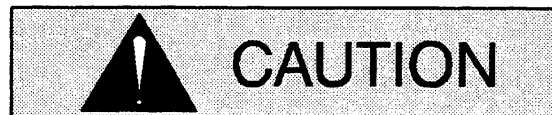

If your pump serial number is followed by an "N", your pump is **NOT** a standard production model.

Pump speed and operating condition points must be within the continuous performance range shown on the curve.

SECTION DRAWING

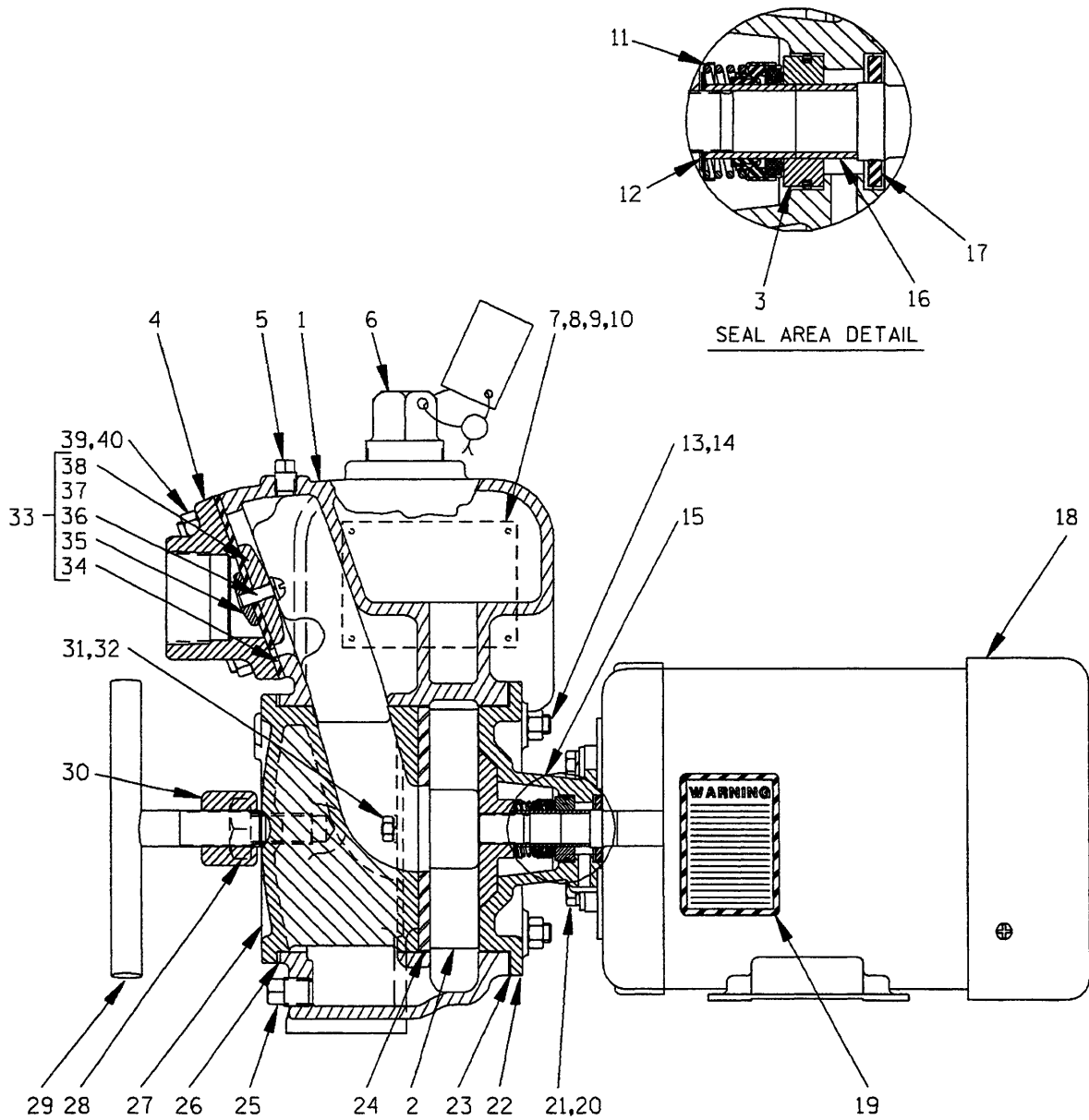

Figure 1. Pump Model 11 1/2A52-E2 1P And 11 1/2A52-E2 3P

PARTS LIST

Pump Model 11 1/2A52-E2 1P And 11 1/2A52-E2 3P

If your pump serial number is followed by an "N", your pump is NOT a standard production model. Contact the Gorman-Rupp Company to verify part numbers.

(From S/N 1146341 up)

ITEM NO.	PART NAME	PART NUMBER	MAT'L CODE	QTY	ITEM NO.	PART NAME	PART NUMBER	MAT'L CODE	QTY
1	PUMP CASING	12367	10010	1	24 *	WEAR PLATE ASSY	2643	15990	1
2 *	IMPELLER	12368A	10010	1	25	CASING DRAIN PLUG	P06	15079	1
3 *	SEAL ASSY	25284-921	----	1	26 *	BACK COVER GSKT	12369G	20000	1
4	SUCTION FLANGE	8599	10010	1	27	BACK COVER PLATE	12369	10010	1
5	PIPE PLUG	P04	15079	1	28	HEX HD CAPSCREW	B0808	15991	2
6	FILL PLUG ASSY	48271-067	----	1	29	CLAMP BAR SCREW	8618	24000	1
7	NAME PLATE	38818-021	13990	1	30	CLAMP BAR	12370	11010	1
8	DRIVE SCREW	BM#04-03	17000	4	31	HEX NUT	D04	15991	2
9	WARNING PLATE	2613EV	13990	1	32	LOCKWASHER	J04	15991	2
10	DRIVE SCREW	BM#04-03	17000	4	33	CHECK VALVE ASSY	1352	----	1
11 *	SPRING CTR WASHER	12658	17100	1	34 *	-CHECK VALVE	1352G	19070	1
12 *	IMP ADJUSTING SHIMS	513A	17090	1	35	-SM VALVE WEIGHT	1354	15160	1
13	STUD	C0605 1/2	15991	4	36	-RD HD MACH SCREW	X0403	17090	1
14	HEX NUT	D06	15991	4	37	-LOCKWASHER	J04	17090	1
15	ROTATION DECAL	2613M	----	1	38	-LG VALVE WEIGHT	1353	10010	1
16 *	SHAFT SLEEVE	2353	17020	1	39	STUD	C0606	15991	4
17 *	SLINGER RING	14049	19140	1	40	HEX NUT	D06	15991	4
18	ELECTRIC MOTOR				NOT SHOWN:				
	-2 HP 1P	28156-550	----	1		WARNING DECAL	2613FE	----	1
	-2 HP 3P	28196-550	----	1		STRAINER	12383	24000	1
19	WARNING DECAL	2613FF	----	1		SUCTION STICKER	6588AG	----	1
20	HEX HD CAPSCREW	B0503S	15991	4		PRIMING STICKER	6588AH	----	1
21	LOCKWASHER	J05	15991	4		DISCHARGE STICKER	6588BJ	----	1
22	INTERMEDIATE	6732A	10010	1		INSTRUCTION DECAL	2613DK	----	1
23 *	CASING GASKET SET	504G	18000	1		INSTRUCTION TAG	38817-013	----	1

* INDICATES PARTS RECOMMENDED FOR STOCK

PUMP AND SEAL DISASSEMBLY AND REASSEMBLY

Review all SAFETY information in Section A.

Follow the instructions on all tags, label and decals attached to the pump.

This pump requires little service due to its rugged, minimum-maintenance design. However, if it becomes necessary to inspect or replace the wearing parts, follow these instructions which are keyed to the sectional view (see Figure 1) and the accompanying parts list.

As described on the following pages, this manual will alert personnel to known procedures which require special attention, to those which could damage equipment, and to those which could be dangerous to personnel. However, this manual cannot possibly anticipate and provide detailed precautions for every situation that might occur during maintenance of the unit. Therefore, it is the responsibility of the owner/maintenance personnel to ensure that **only** safe, established maintenance procedures are used, and that any procedures not addressed in this manual are performed **only** after establishing that neither personal safety nor pump integrity are compromised by such practices.

Before attempting to service the pump, disconnect the incoming power to the motor and lock it out to ensure that the pump will remain inoperative. Close all valves in the suction and discharge lines.

For motor disassembly and repair, consult the literature supplied with the motor, or contact your local motor representative.

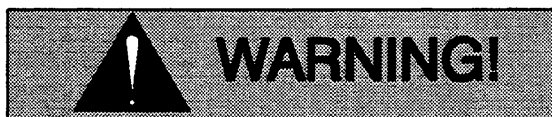

Before attempting to open or service the pump:

1. **Familiarize yourself with this manual.**
2. **Disconnect the incoming power to the motor and lock it out to ensure**

that the pump will remain inoperative.

3. **Allow the pump to completely cool if overheated.**
4. **Check the temperature before opening any covers, plates, or plugs.**
5. **Close the suction and discharge valves.**
6. **Vent the pump slowly and cautiously.**
7. **Drain the pump.**

Suction Check Valve Removal and Disassembly

Before attempting to service the pump, remove the pump casing drain plug (25) and drain the pump. Clean and reinstall the drain plug.

To service the suction check valve assembly (33), remove the suction piping. Remove the nuts (40) securing the suction flange (4) to the pump casing (1). Pull the check valve assembly from the suction port.

Inspect the check valve parts for wear or damage. If replacement is required, remove the hardware (36 and 37), and separate the check valve gasket (34) and weights (35 and 38).

If no further disassembly is required, see **Suction Check Valve Installation**.

Back Cover Removal

The wear plate (24) is easily accessible and may be serviced by removing the back cover assembly (27). Loosen the clamp bar screw (29) and remove the clamp bar (30). Pull the back cover and wear plate from the pump casing. Remove the back cover gasket (26). Clean the mating surfaces of the back cover plate and pump casing.

Inspect the wear plate (24) and replace it if badly scored or worn. To remove the wear plate, disengage the hardware (31 and 32) securing it to the back cover.

If no further disassembly is required, see **Back Cover Installation**.

Pump Casing Removal

To service the impeller or seal assembly, disconnect the discharge piping. Remove the hardware securing the pump casing (1) to the base.

Tie and tag any leveling shims used under the casing mounting feet to ease reassembly.

Remove the nuts (14), and separate the pump casing and gasket set (23) from the intermediate (22). Clean the mating surfaces of the intermediate and pump casing. Tie and tag the gaskets, or measure and record their thickness for ease of reassembly.

Impeller Removal

To loosen the impeller (2), immobilize the motor shaft, and tap the vanes of the impeller in a counterclockwise direction (when facing the impeller) with a block of wood or a soft-faced mallet. **Be careful** not to damage the impeller vanes. Use caution when removing the impeller; tension on the seal spring will be released as the impeller is unscrewed.

Inspect the impeller and replace it if cracked or badly worn. Slide the impeller adjusting shims (12) off the motor shaft. Tie and tag the shims or measure and record their thickness for ease of reassembly.

Seal Removal and Disassembly

Remove the spring centering washer (11) and seal spring. Slide shaft sleeve (16) and rotating portion of the seal off the shaft as a unit. Apply oil to the sleeve and work it under the bellows. Slide the rotating portion of the seal off the sleeve.

To remove the stationary seat and O-ring, remove the hardware (20 and 21), and slide the stationary portion of the seal and intermediate (22) off the shaft as a unit. Position the intermediate on a flat surface with the impeller side down. Use thumb pressure to press the stationary seat and O-ring from the intermediate.

Remove the slinger ring (17) from the shaft.

If no further disassembly is required, see **Seal Reassembly and Installation**.

Seal Reassembly and Installation

Clean the seal cavity and shaft with a cloth soaked in fresh cleaning solvent.



Most cleaning solvents are toxic and flammable. Use them only in a well ventilated area free from excessive heat, sparks, and flame. Read and follow all precautions printed on solvent containers.

Inspect the motor shaft for damage. Small scratches or nicks may be removed with a fine file or emery cloth. If excessive wear exists, the shaft will have to be replaced (refer to the motor service manual).

The seal is not normally reused because wear patterns on the finished faces cannot be realigned during reassembly. This could result in premature failure. If necessary to reuse an old seal in an emergency, **carefully** wash all metallic parts in **fresh** cleaning solvent and allow to dry thoroughly.

Handle the seal parts with extreme care to prevent damage. Be careful not to contaminate precision finished faces; even fingerprints on the faces can shorten seal life. If necessary, clean the faces with a non-oil based solvent and a clean, lint-free tissue. Wipe **lightly** in a concentric pattern to avoid scratching the faces.

Inspect the seal components for wear, scoring, grooves, and other damage that might cause leakage. Clean and polish the shaft sleeve, or replace it if there are nicks or cuts on either end. If any components are worn, replace the complete seal; **never mix old and new seal parts.**

If a replacement seal is being used, remove it from the container and inspect the precision finished faces to ensure that they are free of any foreign matter.

To ease installation of the seal, lubricate the O-rings and shaft sleeve with water or a very **small** amount of oil, and apply a drop of light lubricating oil on the finished faces. Assemble the seal as follows, (see Figure 2).

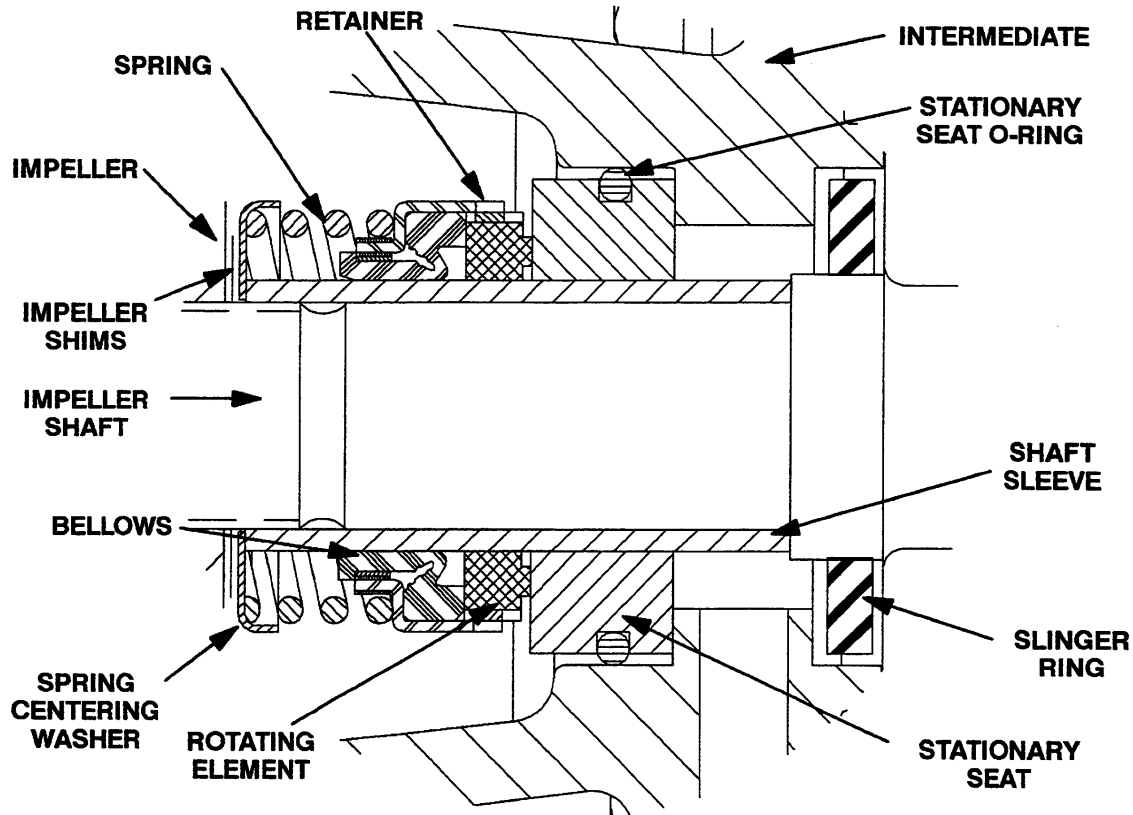
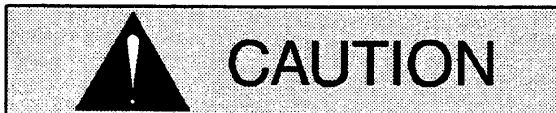

Figure 2. 25284-921 Seal Assembly



This seal is not designed for operation at temperatures above 160°F (71°C). Do not use at higher operating temperatures.

Slide the slinger ring (17) onto the shaft. Install the O-ring in the stationary seat and press this stationary subassembly into the intermediate until fully seated. After installation, wipe the sealing face lightly in a concentric pattern with a clean, lint-free tissue.

Position the intermediate (22) and stationary subassembly over the shaft and against the motor. Secure the intermediate to the motor with the hardware (20 and 21).

Slide the rotating subassembly (consisting of the element, bellows and retainer) over the lubricated shaft sleeve until the rotating element is **just flush** with the chamfered end of the sleeve. Slide the sleeve over the shaft until the sealing faces contact. Continue to press the shaft sleeve through the

seal assembly until it seats squarely against the shaft shoulder.

Install the seal spring and spring centering washer (11).

Impeller Installation And Adjustment

Inspect the impeller, and replace it if cracked or badly worn. Install the same thickness of impeller shims (12) as previously removed, and screw the impeller onto the shaft until tight.

A clearance of .010 to .012 inch (0,25 to 0,30 mm) between the impeller and the intermediate is necessary for maximum pump efficiency. Measure this clearance and add or remove impeller shims until this clearance is reached.

Pump Casing Installation

Install the same thickness of pump casing gaskets (23) as previously removed, and secure the pump casing to the intermediate (22) with the nuts (14). **Do not** fully tighten the nuts at this time.

NOTE

The back cover assembly must be in place to adjust

the impeller face clearance.

A clearance of .008 to .015 inch (0,20 to 0,38 mm) between the impeller and the wear plate is also recommended for maximum pump efficiency. Set this clearance by adding or removing gaskets in the pump casing gasket set (23) until the impeller scrapes against the wear plate when the shaft is turned. After the impeller binds, add approximately .008 inch (0,20 mm) of gaskets.

After the face clearance has been set, tighten the nuts (14) securing the pump casing to the intermediate.

Secure the pump casing to the base with the previously removed hardware. Be sure to reinstall any leveling shims used under the casing mounting feet.

Back Cover Installation

If the wear plate (24) was removed for replacement, secure it to the cover plate (27) using the attaching hardware (31 and 32) at this time. The wear plate must be concentric to prevent binding when the back cover is installed.

Clean any scales or debris from the contacting surfaces on the pump casing that might prevent a good seal with the back cover. Replace the back cover gasket (26) and slide the back cover assembly into the pump casing. Be sure the wear plate does not bind against the impeller.

NOTE

To ease future disassembly, apply a film of grease or 'Never-Seez' on the back cover shoulder, or any surface that contacts the pump casing. This action will reduce rust and scale build-up.

Secure the back cover assembly by installing the clamp bar (30) and tightening the clamp bar screw (29). **Do not** over-tighten the clamp bar screw; it

should be just tight enough to seal the back cover shoulder.

Suction Check Valve Installation

Inspect the check valve components and replace as required. Subassemble the check valve weights (35 and 38) and check valve (34) using the attaching hardware (36 and 37).

Position the check valve assembly (33) in the suction port with the large weight toward the inside of the pump casing. Install the suction flange (4), and secure with the nuts (40). Check the operation of the check valve to ensure proper seating and free movement.

Final Pump Assembly

Be sure the pump and motor are securely mounted to the base.

Install the suction and discharge lines and open all valves. Make certain that all piping connections are tight, properly supported and secure.

Be sure the pump and motor have been properly lubricated, see **LUBRICATION**.

Remove the fill plug assembly (6) and fill the pump casing with clean liquid. Reinstall the fill plug and tighten it.

Refer to **OPERATION**, Section C, before putting the pump back into service.

LUBRICATION

Seal Assembly

The seal assembly is lubricated by the medium being pumped, and no additional lubrication is required.

Motor

Consult the literature supplied with the motor, or contact your local motor representative.

**For U.S. and International Warranty Information,
Please Visit www.grpumps.com/warranty
or call:
U.S.: 419-755-1280
International: +1-419-755-1352**

**For Canadian Warranty Information,
Please Visit www.grcanada.com/warranty
or call:
519-631-2870**