

**INSTALLATION, OPERATION,  
AND MAINTENANCE MANUAL**  
WITH PARTS LIST



**SUBMERSIBLE DRY PIT PUMP**

MODEL
<b>SFDV3A &amp; SFDEV3A</b>

**GORMAN-RUPP PUMPS**

[www.grpumps.com](http://www.grpumps.com)

Register your new  
Gorman-Rupp pump online at  
**[www.grpumps.com](http://www.grpumps.com)**

Valid serial number and e-mail address required.

**RECORD YOUR PUMP MODEL AND SERIAL NUMBER**

Please record your pump model and serial number in the spaces provided below. Your Gorman-Rupp distributor needs this information when you require parts or service.

Pump Model: \_\_\_\_\_

Serial Number: \_\_\_\_\_

# TABLE OF CONTENTS

<b>INTRODUCTION</b> .....	<b>PAGE I – 1</b>
<b>SAFETY - SECTION A</b> .....	<b>PAGE A – 1</b>
<b>INSTALLATION – SECTION B</b> .....	<b>PAGE B – 1</b>
PREINSTALLATION INSPECTION .....	PAGE B – 1
PUMP SEALS .....	PAGE B – 1
LUBRICATION .....	PAGE B – 1
PUMP INSTALLATION .....	PAGE B – 1
Pump Dimensions .....	PAGE B – 1
Pump Motor Specifications .....	PAGE B – 1
Lifting .....	PAGE B – 2
Positioning the Pump .....	PAGE B – 2
Piping .....	PAGE B – 2
ELECTRICAL CONNECTIONS .....	PAGE B – 2
Field Wiring Connections (Incoming Power) .....	PAGE B – 2
Dual Vlotage .....	PAGE B – 3
Motor Cable Grounding Test .....	PAGE B – 3
Control Box Connections .....	PAGE B – 3
Liquid Level Devices .....	PAGE B – 4
<b>OPERATION – SECTION C</b> .....	<b>PAGE C – 1</b>
GENERAL INFORMATION .....	PAGE C – 1
Pump Performance .....	PAGE C – 1
Control Box .....	PAGE C – 4
PUMP OPERATION .....	PAGE C – 4
Liquid Temperature And Overheating .....	PAGE C – 4
Impeller Rotation .....	PAGE C – 5
STARTING, STOPPING AND OPERATIONAL CHECKS .....	PAGE C – 5
Starting .....	PAGE C – 5
Stopping .....	PAGE C – 6
Operational Checks .....	PAGE C – 6
LUBRICATION .....	PAGE C – 6
Draining Oil .....	PAGE C – 7
Condition of Oil Oil .....	PAGE C – 7
Adding Oil .....	PAGE C – 7
<b>TROUBLESHOOTING – SECTION D</b> .....	<b>PAGE D – 1</b>
PREVENTIVE MAINTENANCE .....	PAGE D – 3
<b>PUMP MAINTENANCE AND REPAIR - SECTION E</b> .....	<b>PAGE E – 1</b>
GENERAL INFORMATION .....	PAGE E – 1
Lifting .....	PAGE E – 1

**TABLE OF CONTENTS**  
**(continued)**

PARTS LISTS:	
Pump Model Assembly .....	PAGE E – 3
Motor Assemblies .....	PAGE E – 5
PUMP AND SEAL DISASSEMBLY AND REASSEMBLY .....	PAGE E – 6
PUMP END DISASSEMBLY .....	PAGE E – 6
Preparing Pump for Disassembly .....	PAGE E – 6
Pump Casing Removal .....	PAGE E – 7
Draining Oil From Seal Cavity .....	PAGE E – 7
Impeller Removal .....	PAGE E – 7
Lower Seal Removal .....	PAGE E – 8
Upper Seal Removal .....	PAGE E – 8
PUMP END REASSEMBLY .....	PAGE E – 8
Cleaning and Inspection of Pump Parts .....	PAGE E – 8
Upper Seal Installation .....	PAGE E – 9
Lower Seal Installation .....	PAGE E – 10
Impeller Installation .....	PAGE E – 11
Pump Casing Installation .....	PAGE E – 11
Final Assembly .....	PAGE E – 11
MOTOR DISASSEMBLY .....	PAGE E – 11
Hoisting Bail Removal .....	PAGE E – 12
Terminal Housing Assembly Removal .....	PAGE E – 12
Rotor Shaft and Bearing Removal .....	PAGE E – 12
Stator Removal .....	PAGE E – 13
MOTOR REASSEMBLY .....	PAGE E – 13
Stator Installation .....	PAGE E – 14
Bearing and Rotor Shaft Installation .....	PAGE E – 14
Terminal Housing Assembly Installation .....	PAGE E – 16
Hoisting Bail Installation .....	PAGE E – 17
VACUUM TESTING .....	PAGE E – 17
Seal Cavity Testing .....	PAGE E – 17
Seal and Motor Cavity Testing .....	PAGE E – 17
LUBRICATION .....	PAGE E – 18
Seal Cavity .....	PAGE E – 18
Motor Bearings .....	PAGE E – 19

## INTRODUCTION

**Thank You** for purchasing a Gorman-Rupp pump. **Read this manual** carefully to learn how to safely install and operate your pump. Failure to do so could result in personal injury or damage to the pump.

Because pump installations are seldom identical, this manual cannot possibly provide detailed instructions and precautions for every aspect of each specific application. Therefore, it is the responsibility of the owner/installer of the pump to ensure that applications not addressed in this manual are performed **only** after establishing that neither operator safety nor pump integrity are compromised by the installation. Pumps and related equipment **must** be installed and operated according to all national, local and industry standards.

If there are any questions regarding the pump or its application which are not covered in this manual or in other literature accompanying this unit, please contact your Gorman-Rupp distributor, or The Gorman-Rupp Company:

**The Gorman-Rupp Company**  
**P.O. Box 1217**  
**Mansfield, Ohio 44901—1217**  
**Phone: (419) 755—1011**  
 or:  
**Gorman-Rupp of Canada Limited**  
**70 Burwell Road**  
**St. Thomas, Ontario N5P 3R7**  
**Phone: (519) 631—2870**

For information or technical assistance on the power source, contact the power source manufacturer's local dealer or representative.

## HAZARD AND INSTRUCTION DEFINITIONS

The following are used to alert maintenance personnel to procedures which require special attention, to those which could damage equipment, and to those which could be dangerous to personnel:



**Immediate hazards which WILL result in severe personal injury or death. These instructions describe the procedure required and the injury which will result from failure to follow the procedure.**



**Hazards or unsafe practices which COULD result in severe personal injury or death. These instructions describe the procedure required and the injury which could result from failure to follow the procedure.**



Hazards or unsafe practices which COULD result in minor personal injury or product or property damage. These instructions describe the requirements and the possible damage which could result from failure to follow the procedure.

### NOTE

*Instructions to aid in installation, operation, and maintenance or which clarify a procedure.*

## SAFETY – SECTION A

This information applies to the SF Series submersible pump indicated on the front cover of this manual.

In addition to this manual, see the separate literature covering the control box, control accessories or other equipment shipped with this pump.

Because pump installations are seldom identical, this manual cannot possibly provide detailed instructions and precautions for each specific application. Therefore, it is the owner/installer's responsibility to ensure that applications not addressed in this manual are performed only after establishing that neither operator safety nor pump integrity are compromised by the installation.



Before attempting to install, operate, or service this pump, familiarize yourself with this manual, and with all other literature shipped with the pump. Unfamiliarity with all aspects of pump operation covered in this manual could lead to destruction of equipment, injury, or death.



This pump is designed to handle raw sewage and industrial wastes at temperatures of 104°F (40°C); Do not apply at higher temperatures. Do not attempt to pump volatile, flammable, or corrosive liquids which may damage the pump or endanger personnel as a result of pump failure.



The electrical power used to operate this pump is high enough to cause injury or death. Obtain the services of a qualified electrician to make all electrical connections.



The following precautions should be taken before attempting to open or service the pump; otherwise, injury or death could result.

1. Familiarize yourself with this manual.
2. Lock out incoming power to the control box to ensure that the pump will remain inoperative.
3. Allow the pump to completely cool if overheated.
4. Close the discharge valve (if used).



230V and 460V versions of this pump are dual-voltage; however, they are wired at the factory only for the voltage shown on the nameplate. Do not attempt to change the voltage in the field. If desired to have the voltage changed, return the pump to the factory or to an authorized Gorman-Rupp repair facility only. Otherwise, damage to the pump and injury or death to personnel can result.



Do not connect the pump motor directly

to the incoming power lines. The pump motor is designed to operate through a Gorman-Rupp approved control box which provides overload protection and power control; otherwise, the pump warranty will be voided. Make certain that the pump and control box are properly grounded and that the incoming power matches the requirements of the pump and controls. Install and operate the control box in accordance with the National Electric Code and all local codes. Failure to follow the instructions in this warning could result in injury or death to personnel.



Death or serious personal injury and damage to the pump or components can occur if proper lifting procedures are not observed. Make certain that hoists, chains, slings or cables are in good working condition and of sufficient capacity and that they are positioned so that loads will be balanced and the pump or components will not be damaged when lifting. Do not attempt to lift this pump by the motor or control cables, or the piping. Attach proper lifting equipment to the lifting bail fitted on the pump. Lift the pump or component only as high as necessary and keep personnel away from suspended objects.



The electrical power used to operate this pump is high enough to cause injury or death. Obtain the services of a qualified electrician to make all electrical connections. Make certain that the pump and enclosure are properly grounded; never use gas pipe as an

electrical ground. Be sure that the incoming power matches the voltage and phase of the pump and control before connecting the power source. Do not run the pump if the voltage is not within the limits. If the overload unit is tripped during pump operation, correct the problem before restarting the pump.



The electrical power used to operate this pump is high enough to cause injury or death. Make certain that the control handle on the control box is in the OFF position and locked out, or that the power supply to the control box has been otherwise cut off and locked out, before attempting to open or service the pump assembly. Tag electrical circuits to prevent accidental start-up.



Never attempt to alter the length or repair any power cable with a splice. The pump motor and cable must be completely waterproof. Injury or death may result from alterations.



All electrical connections must be in accordance with The National Electric Code and all local codes. If there is a conflict between the instructions provided and N.E.C. Specifications, N.E.C. Specifications shall take precedence. All electrical equipment supplied with this pump was in conformance with N.E.C. requirements in effect on the date of manufacture. Failure to follow applicable specifications, or substitution of electrical parts not supplied or

approved by the manufacturer, can result in severe injury or death and void warranty.



After the pump has been installed, make certain that the pump and all piping or hose connections are secure before operation.



Approach the pump cautiously after it has been running. Although the motor is cooled by dispersing heat through the motor housing cooling fins into the liquid being pumped, normal operating temperatures can still be high enough to cause burns. The temperature will be especially high if operated against a closed discharge valve. Never operate against a closed discharge valve for long periods of time.



Do not remove plates, covers, gauges, pipe plugs, or fittings from an overheated pump. Vapor pressure within the pump can cause parts being disengaged to be ejected with great force. Allow the pump to completely cool before servicing.



If this pump is used to handle sewage, take necessary precautions during maintenance and repair to prevent personal contamination which could result in illness.



Pumps and related equipment must be installed and operated according to all national, local and industry standards.



## INSTALLATION – SECTION B

### Review all SAFETY information in Section A.

Since pump installations are seldom identical, this section is intended only to summarize general recommendations and practices required to inspect, position, and arrange the pump and piping. If there are any questions concerning your specific installation, contact your Gorman-Rupp distributor or the Gorman-Rupp Company.

Automatic liquid level controls are available from Gorman-Rupp as options. For information on installing and operating these controls, see the technical data accompanying them.

### PREINSTALLATION INSPECTION

The pump assembly was inspected and tested before shipment from the factory. Before installation, check for damage which may have occurred during shipment. Check as follows:

- a. Inspect the pump assembly for cracks, dents, damaged threads, and other obvious damage.
- b. Check for and tighten loose attaching hardware.
- c. Inspect the power cable for cuts or any other obvious damage.
- d. Check that amperes, phase, voltage, and hertz indicated on the motor name plate match the ratings on the control box and incoming power.
- e. Carefully read all tags, decals, and markings on the pump assembly, and perform all duties indicated.
- f. Check for any oil leaks. If there is any indication of an oil leak, see **LUBRICATION in MAINTENANCE AND REPAIR – SECTION E**.

### PUMP SEALS

This pump is equipped with two mechanical seals. The lower seal is lubricated by the liquid being pumped and prevents the liquid from entering the seal housing cavity from the pump end. The upper seal prevents oil from escaping from the seal housing into the motor housing and acts as backup protection in the event of lower seal failure.

### LUBRICATION

The seal cavity is fully lubricated when shipped from the factory. However, the lubrication level **must be checked** before installing the pump (see **LUBRICATION in MAINTENANCE AND REPAIR – SECTION E**). If the oil level is abnormally low, determine the cause before putting the pump into service.

The shaft bearings are permanently lubricated.

There is no other lubrication in the pump.

### PUMP INSTALLATION

#### Pump Dimensions

For the approximate physical dimensions of your pump, refer to the pump specification data sheet or contact your Gorman-Rupp distributor or the Gorman-Rupp Company.

#### Pump Motor Specifications

The motor furnished with this pump is a 60 Hz., Squirrel Cage, Induction Start, Class H Insulation Rated 365°F (180°C).

See Table B-1 for motor specifications.

TABLE B-1. PUMP MOTOR SPECIFICATIONS						
MODEL	VOLTAGE/ PHASE	SIZE	H.P.	MOTOR RPM	MAX LOAD AMPS	LOCKED ROTOR AMPS
SFDV3A, SFDEV3A	208/3	3"	2.5	1750	7.30	55.30
SFDV3A, SFDEV3A	230-460-575/3	3"	3.0	1750	7.80/3.90/3.12	50.0/25.0/20.0

**Lifting**

Pump unit weights will vary depending on the mounting and drive provided. Check the shipping tag on the unit packaging for the actual weight, and use lifting equipment with appropriate capacity. Drain the pump and remove all customer-installed equipment such as suction and discharge hoses or piping before attempting to lift existing, installed units.

**Positioning the Pump**

**NOTE**

*Before installing and operating the pump, check the direction of impeller rotation to ensure that the pump is properly wired at the control box. See **IMPELLER ROTATION, SECTION C.***

This pump is designed to be operated mounted on a stand with an optional suction elbow.

Install and secure the stand in the floor of the dry pit.

Position the pump on the stand. Install the screws through the suction elbow and stand and tighten fully.

Make certain that the pump and stand sit level in the dry pit.

**Piping**

**NOTE**

*Refer to **Pump Performance in OPERATION – SECTION C** when determining the most efficient piping installation.*

Either hose or rigid pipe may be used to make discharge connections.

The discharge and suction lines must be independently supported to avoid vibration and strain on the pump. For maximum pumping capacity, keep the lines as short and straight as possible. Elbows and fittings used in a the lines increase friction losses; minimize their use.

It is recommended that a check valve or throttling valve be installed in the discharge line to control siphoning or back flow when the pump is shut off.

**ELECTRICAL CONNECTIONS**



**Install and operate this pump in accordance with the National Electrical Code and all local codes. Have a qualified electrician perform all checks and connections in this section.**

**Never attempt to alter the length of the pump motor cable or to repair it with a splice. The power cable and pump motor must be kept completely waterproof. Serious damage to the pump and injury or death to personnel can result from any alteration to the cable.**

**Field Wiring Connections (Incoming Power)**

Field wiring is **not** provided with this pump, and must be supplied by the user. The field wiring must be of the proper size and type to ensure an adequate voltage supply to the pump. Voltage available at the motor must be within the range indicated in Table B-2.

TABLE B-2. MOTOR VOLTAGE LIMITS			
NOMINAL VOLTAGE	PHASE	MINIMUM VOLTAGE	MAXIMUM VOLTAGE
230	1	207	253
208	3	187	229
230	3	207	253
460	3	414	506
575	3	517	632

Use conduit cable clamps to secure the incoming field wiring to the control box. Make certain all connections are tight. If necessary, support the cable weight to prevent excessive strain on cable clamps and cable.

**Dual Voltage**



**230V and 460V versions of these pumps are dual-voltage; however, they are wired at the factory only for the voltage shown on the nameplate. Do not attempt to change the voltage in the field. If desired to have the voltage changed, return the pump to the factory or to an authorized Gorman-Rupp repair facility only. Otherwise, damage to the pump and injury or death to personnel can result.**

**Motor Cable Grounding Test**



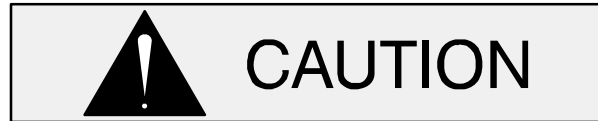
**Do not connect the pump power or control cables to the control box or incoming voltage before verifying the pump ground. Otherwise, personnel will be exposed to serious injury or death.**

Connect one lead of a lamp, bell or similar testing device to the motor cable green/yellow ground

lead (s). Connect the second test lead to an **uninsulated** point on the pump body. The test circuit should close.

If the test circuit does not close, there is a defect in the cable or motor which must be corrected.

**Control Box Connections**



The pump warranty is void if the motor is not operated through a control box approved by Gorman-Rupp.

This pump is shipped completely wired for the voltage shown on the nameplate and is ready for operation through an approved control box.

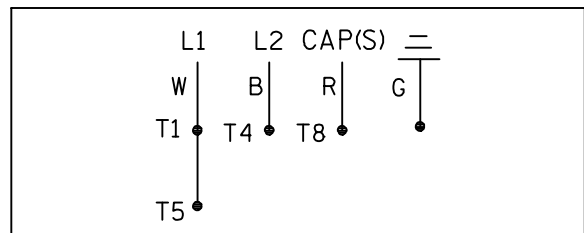
Ground the control box in accordance with the instructions accompanying it.

Ground the pump to the control box using the power cable ground(s) and ground check wire (if so equipped). Secure the ground wire(s) and ground check wire (if so equipped) to the grounding lug(s) inside the control box to ensure a thorough ground for the pump.

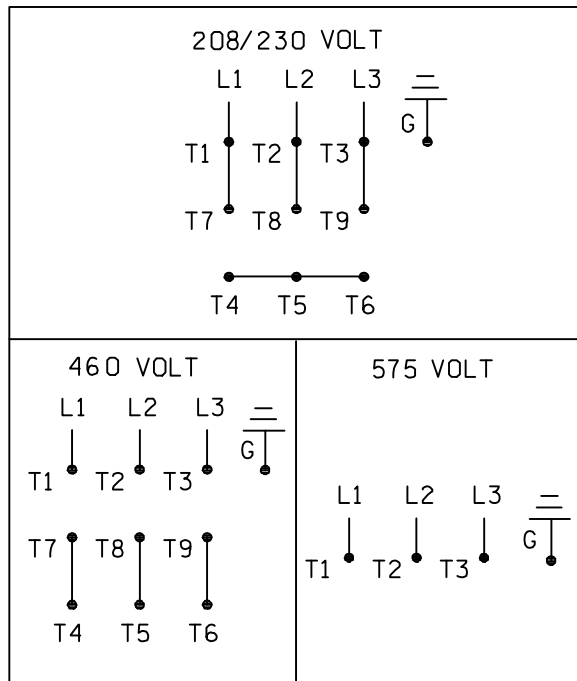


**Ground the pump using the power cable ground wire(s) before applying line potential. Failure to properly ground the pump could result in damage to the pump or control and/or injury or death to personnel.**

Refer to Figures B-1 or B-2 and connect the pump motor cable to the control box.

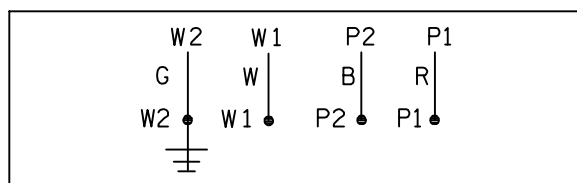


**Figure B-1. Single Phase Power Cable Connections**



**Figure B-2. Three Phase Power Cable Connections**

Control leads P1 and P2 provide the motor with thermal protection. Control leads W1 and W2 provide the motor with moisture protection. Refer to Figure B-3 and connect the pump control cable to the control box.



**Figure B-3. Control Cable Connections**



The thermal protection contacts will automatically reclose when the motor cools to the established safe operating temperature. Whenever automatic restarting is not desirable, connect only to controls which are wired for manual restart.

Refer to the appropriate wiring diagram accompanying the control box when making electrical connections.

**Liquid Level Devices**

Optional controls available from Gorman-Rupp may provide a means to automatically regulate the liquid level. These control boxes may be connected to the following sensing devices which perform **either** filling or dewatering functions (see Figure B-4).



The internal wiring of the sensing devices are different for filling and dewatering functions. Be sure to follow the instructions included with the option before making connections.

- **Diaphragm Type:** two fixed-position sensors (upper and lower) each contain a diaphragm which flexes with changes in liquid level, thus activating an enclosed miniature switch.
- **Bulb (Float) Type:** a bulb raises or lowers (floats) with the liquid level, thus activating an enclosed miniature switch.

Other types of liquid level devices may also be used. Consult the factory for the liquid level device best suited for your application.



Liquid level devices **must** be positioned far enough to allow 6 minutes between starts. If the pump motor cycles more than 10 starts per hour, it will over-heat, resulting in damage to the motor windings or control box components.

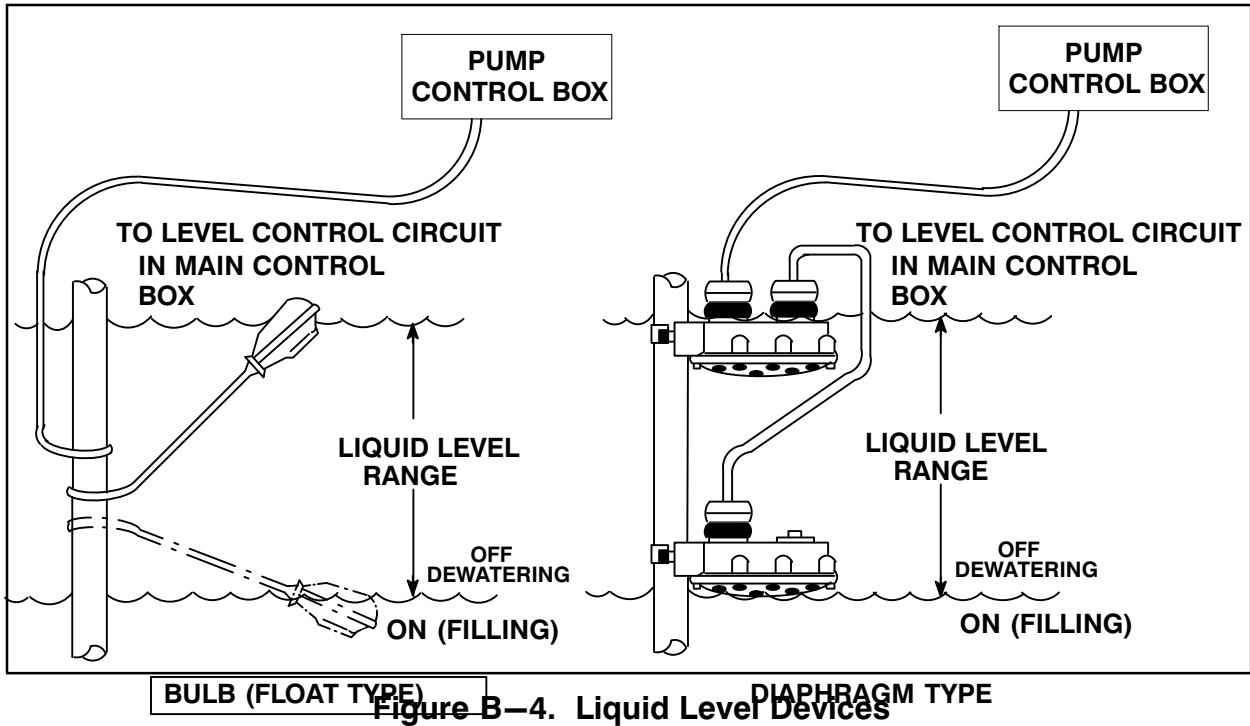


Figure B-4. Liquid Level Devices

## OPERATION – SECTION C

### GENERAL INFORMATION

Review all SAFETY information in Section A.



**This pump is designed to handle most non-volatile, non-flammable liquids. Do not attempt to pump any liquids for which your pump is not approved, or which may damage the pump or endanger personnel as a result of pump failure. Consult the factory for specific application data.**

Follow the instructions on all tags, labels and decals attached to the pump.

#### Pump Performance



Since operation of the pump motor is de-

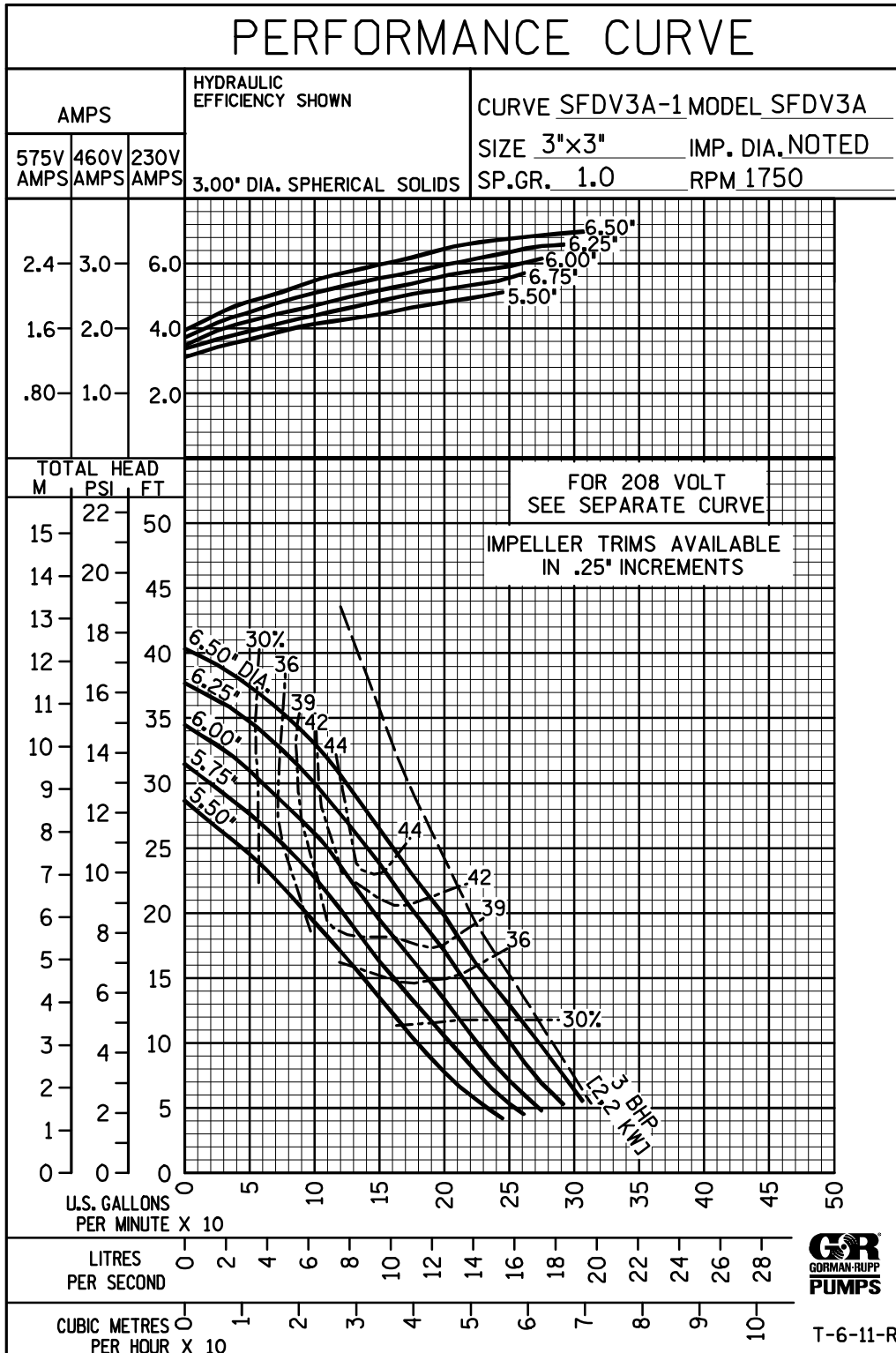
pendent upon the quality and performance of the electrical controls, the pump warranty is valid only when controls have been specified or provided by The Gorman-Rupp Company.

In the performance curves which follow, performance is based on 70°F (21°C) clear water at sea level. The performance of your pump may be different due to such factors as viscosity, specific gravity, elevation, temperature and impeller trim.

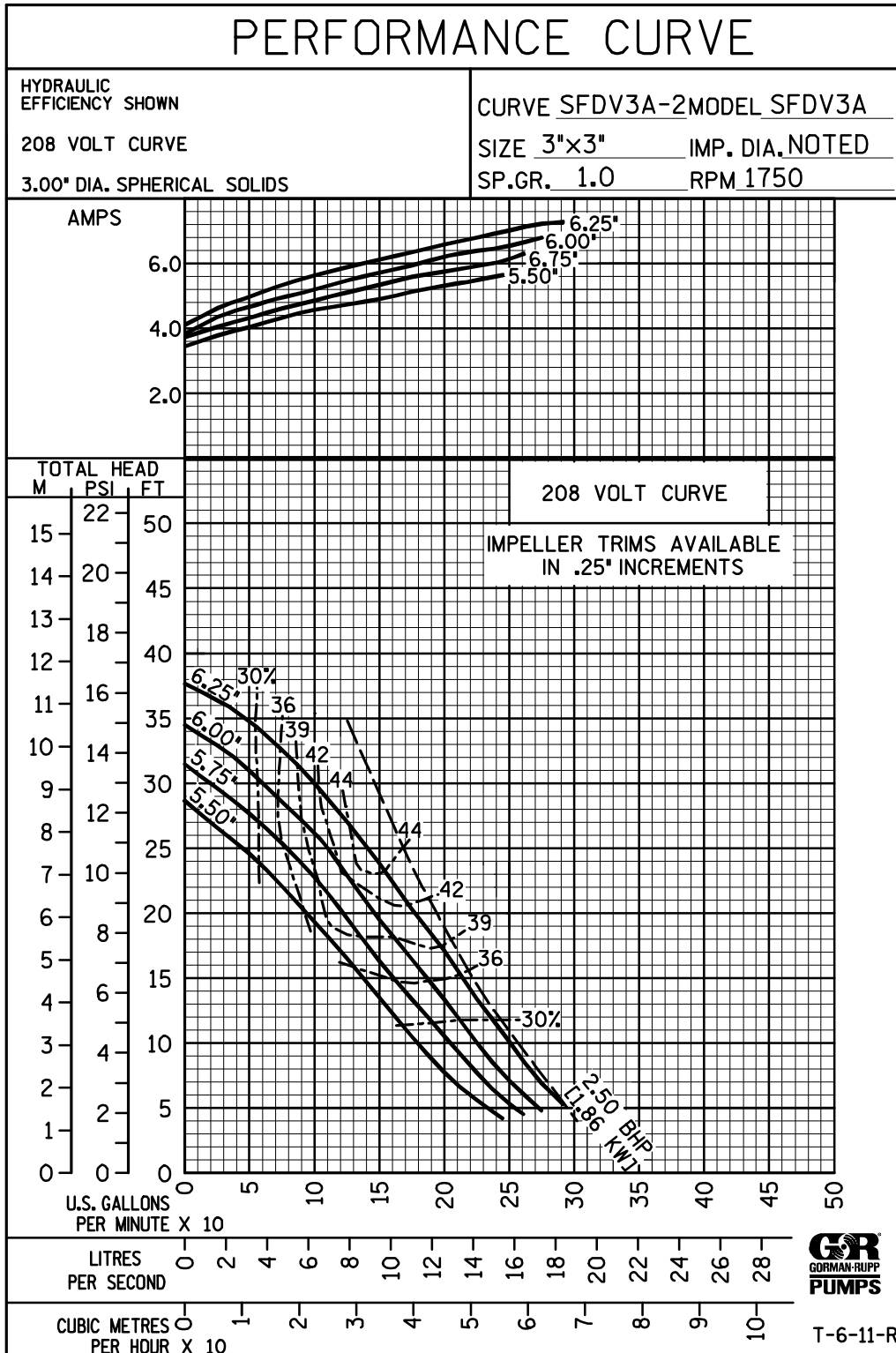
#### NOTE

*The curves apply to standard production models. If your pump serial number is followed by an "N", your pump is **not** a standard production model. Contact the Gorman-Rupp Company to verify performance.*

---

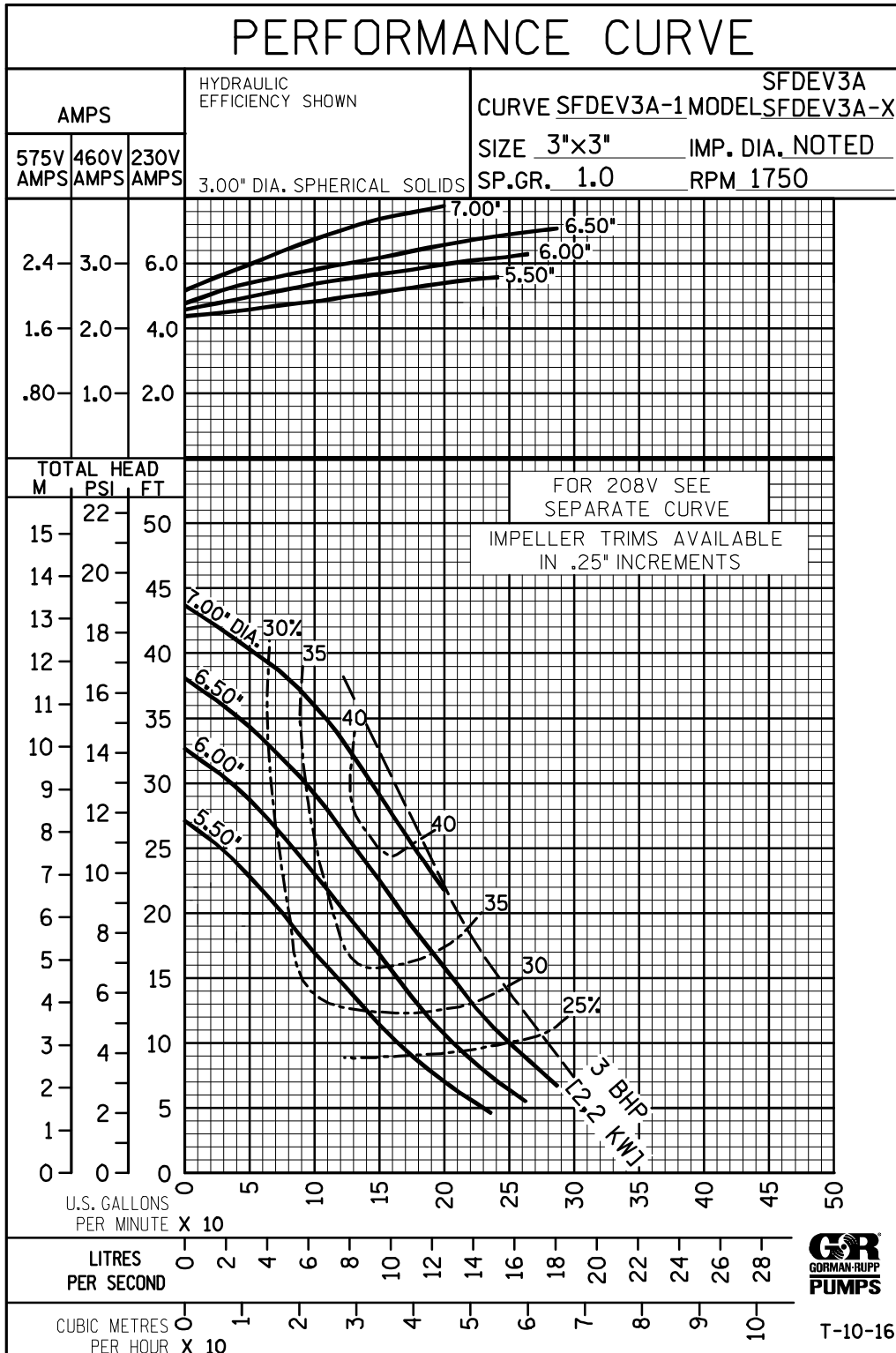


SFDV3A 230/460/575V PERFORMANCE CURVE

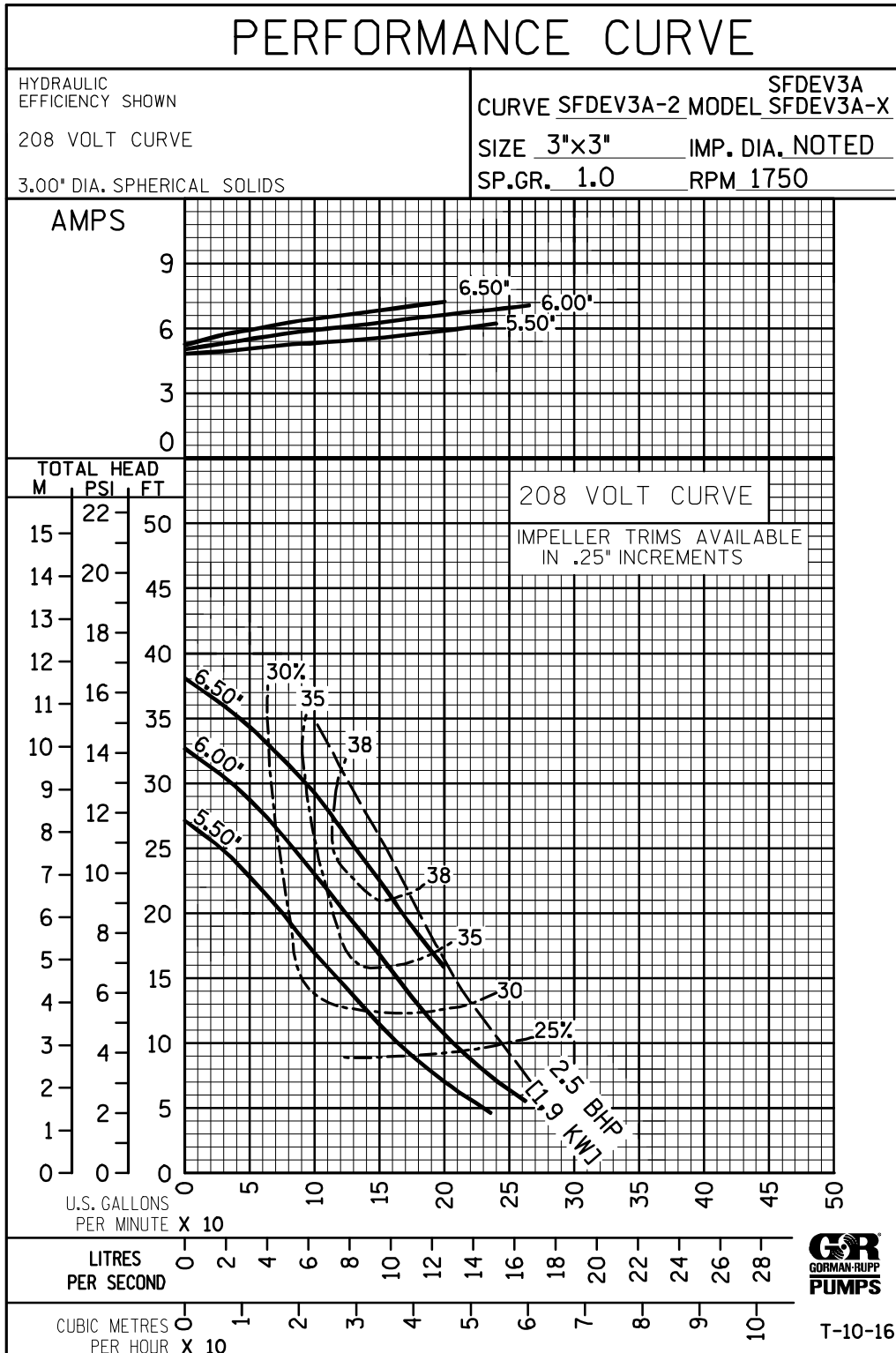


**SFDV3A 208V PERFORMANCE CURVE**





**SFDEV3A 230/460/575V PERFORMANCE CURVE**



**SFDEV3A 208V PERFORMANCE CURVE**

## Control Box

Control boxes are available as optional equipment from the factory. The control boxes contain controls for starting and stopping the pump, and provide overload protection for the pump motor. The pump control may be equipped with an optional automatic liquid level sensing device, in which case those circuits are also contained within the control box.

Since operation of the pump motor is dependent upon the quality and performance of the electrical controls, the pump warranty is valid only when controls have been specified or provided by The Gorman-Rupp Company.



**The pump motor and control box are not designed to be explosion-proof. Do not operate in an explosive atmosphere. Any control box used to operate the pump must be approved by the Gorman-Rupp Company for the application. Improper location of a non-explosion proof control box could result in destruction of equipment, injury or death to personnel.**

See the operating instructions furnished with the control box, and with other optional accessories and controls, before attempting to start the pump.

## PUMP OPERATION

### Liquid Temperature and Overheating.



**Overheated pumps can cause severe burns and injury. If the pump becomes overheated:**

1. Stop the pump immediately.

2. Lock out the power to the control panel to ensure that the pump will remain inoperative.
3. Allow the pump to completely cool if overheated.
4. Close the discharge valve (if used).
5. Refer to instructions in this manual before restarting the pump.

Overheating can occur if the pump is misapplied; if it is started more than 10 times within one hour; if the temperature of the liquid being pumped exceeds the temperature for which the pump was designed, if the control box fails to provide overload or thermal protection, or if the pump is operated against a closed discharge valve for an extended period of time.



Do not start the pump more than 10 times per hour. If the motor does not cool between starts it will overheat, resulting in damage to the motor windings.



**Approach the pump cautiously after it has been running. Although the motor is cooled by the liquid being pumped, normal operating temperatures can be high enough to cause burns. The temperature will be especially high if operated against a closed discharge valve. Never operate against a closed discharge valve for long periods of time.**

If overheating does occur, stop the pump immediately and allow it to cool before servicing it. Approach any overheated pump cautiously.



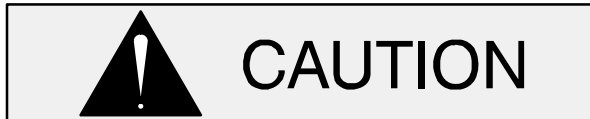
**Overheated pumps can cause severe**

burns and injuries. If overheating of the pump occurs:

1. Stop the pump immediately.
2. Ventilate the area.
3. Allow the pump to completely cool.
4. Check the temperature before servicing.
5. Vent the pump slowly and cautiously
6. Refer to instructions in this manual before restarting the pump.

#### Impeller Rotation

Check impeller rotation as follows before operation to ensure that the impeller is rotating in the correct direction.



While checking impeller rotation, secure the pump to prevent the power cable from coiling.

Suspend the pump from the lifting device fitted on the pump. Apply power briefly and note the direction of pump kickback. As viewed from the top, the pump should kick in a **counterclockwise** direction; this will indicate that impeller rotation is correct.

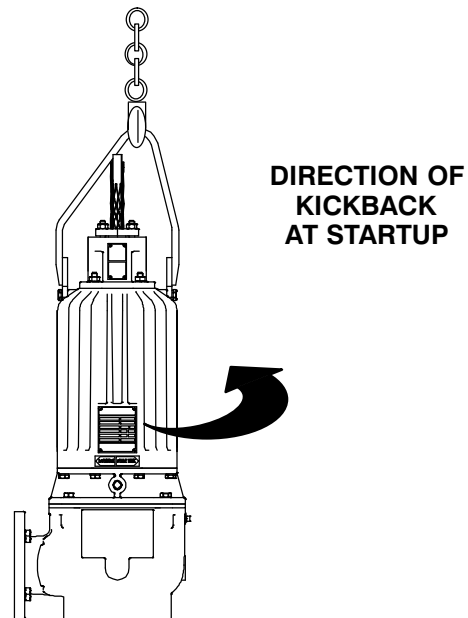
If the pump kicks in a **clockwise** direction, impeller rotation is incorrect. If the pump is powered by a three-phase motor, have a qualified electrician interchange the control box connections of any two pump motor power leads. Re-check pump kickback; it should now be in a counterclockwise direction.

If rotation is incorrect on a single-phase motor, contact the factory before installing the pump.



**The electrical power used to operate this pump is high enough to cause inju-**

**ry or death. Make certain that incoming power is off and locked out before interchanging motor leads.**



**Figure C-1. Checking Pump Rotation**

### STARTING, STOPPING, AND OPERATIONAL CHECKS

#### Starting



Do not attempt to operate the pump until impeller rotation has been checked; improper rotation will affect pump performance and may damage the pump.

Follow the instructions accompanying the control box, start the pump, and run any recommended checks.



Do not start the pump more than 10 times per hour. If the pump motor does not cool

between starts, it will over-heat, resulting in damage to the motor windings.

### Stopping

Follow the instructions accompanying the control box for stopping the pump.



**The integral thermal overload device will shut off the motor if the temperature rises above design limits. When the pump cools and the temperature falls below these limits, the motor will restart automatically. To avoid the hazards of an unexpected motor start-up, do not attempt to handle or service the pump unless all power to the motor has been shut off and locked out at the control box; otherwise, serious personal injury could result.**

**During motor shutoff by the thermal overload device, control box circuits remain live. Do not attempt to service any control box components unless incoming power has been shut off.**

To stop the pump, turn the control handle OFF, thereby opening the circuit breakers. This **does not** terminate incoming power through the field wiring connected to the control box.

After stopping the pump, be sure to perform all required maintenance and preservation procedures.

### Operational Checks

To detect minor problems, check the pump for proper operation when it is first started, and at periodic intervals during operation.



To avoid serious damage to the pump,

check for unusual noises or excessive vibration while the pump is running. If noise or vibration is excessive, stop operation and refer to the troubleshooting chart in the maintenance and repair manual.

The suction inlet or impeller may become clogged with debris. In some cases, stopping the pump momentarily may backflush this blockage. If back-flushing does not clear the debris, remove the pump from the dry pit and clear manually.



**Never introduce air or steam pressure into the pump casing to remove a blockage. This could result in personal injury or damage to the equipment. If back-flushing is absolutely necessary, limit liquid pressure input to 50% of the maximum permissible operating pressure shown in the pump performance curve.**

Check the pump for overheating. Overheating can occur if the pump is misapplied, required to start repeatedly, if the control box fails to provide overload or thermal protection, or if the pump is operated against a closed discharge valve for an extended period of time.



Do not start the pump more than 10 times per hour. If the motor does not cool between starts it will overheat, resulting in damage to the motor windings.

Check the oil level(s) as indicated in the following **LUBRICATION** section.

### LUBRICATION



**Do not remove plates, covers, gauges,**

**pipe plugs or fittings from an overheated pump. Vapor pressure within the pump can cause parts being disengaged to be ejected with great force. Allow the pump to completely cool before servicing.**

On a new pump, check the oil level in the seal cavity before initial startup, and drain and replace the oil after the first 200 hours of operation. Following this, check the oil level in the seal cavity after the first two weeks of operation, and every month thereafter.

Before installing or removing the lubrication plugs, always clean the area around the plugs to prevent contamination.

### Draining Oil

Refer to the Parts List in **Maintenance and Repair – Section E** for drain plug location.

Lay the pump on its side with one of the pipe plugs (6) facing up. Clean any dirt from around the plug. Remove the plug slowly to release any pressure and install a short 3/8-inch NPT nipple in the hole. Roll the pump and drain the seal oil into a **clean** container.

### Condition Of Oil

Check the condition of the oil drained from the pump. Clear oil indicates that the pump seal(s) are functioning properly. If the oil is milky or contains a small amount of water, it must be changed.

If the oil contains a large amount of water, it must be changed, and the seal(s) must be checked before the pump is put back in operation (**Maintenance and Repair – Section E**).

### Adding Oil

Refer to **Maintenance and Repair – Section E** for the oil capacity for filling the seal cavity in your pump.

The grade of lubricant used is critical to the operation of this pump. Use premium quality submersible pump oil as specified in Table E-2 in **Maintenance and Repair – Section E**. Oil must be stored in a clean, tightly closed container in a reasonably dry environment.

When lubricating the seal cavity, position the pump vertically after draining the oil as indicated above in **Draining Oil**. Add premium quality submersible pump oil through the fill plug hole until the oil is level with the bottom of the plug hole.

Install and tighten the fill plug.

## TROUBLESHOOTING – SECTION D

Review all **SAFETY** information in Section A.

### NOTE

*Many of the probable remedies listed in the **TROUBLESHOOTING CHART** require use of electrical test instruments; for specific procedures, see **ELECTRICAL TESTING** at the end of the chart.*

### TROUBLESHOOTING CHART

TROUBLE	POSSIBLE CAUSE	PROBABLE REMEDY
PUMP FAILS TO START, OVERLOAD UNIT NOT TRIPPED (MANUAL MODE).	<p>Power source incompatible with control box.</p> <p>No voltage at line side of circuit breaker.</p> <p>Open circuit in motor windings or power cable.</p> <p>Defective motor power cable.</p> <p>Defective motor.</p>	<p>Correct power source.</p> <p>Check power source for blown fuse, open circuit breaker, broken lead or loose connections.</p> <p>Check continuity.</p> <p>Replace cable.</p> <p>Check for and replace defective motor components.</p>
PUMP FAILS TO START, OVERLOAD UNIT NOT TRIPPED (AUTOMATIC MODE).	<p>Liquid level device or control circuits improperly connected to main control box.</p> <p>Level sensing device(s) improperly positioned.</p> <p>Level sensing device(s) fouled with mud or foreign material.</p> <p>Float type sensing device(s) tangled or obstructed.</p> <p>Defective liquid level sensing device(s) or control panel.</p>	<p>Check wiring diagrams: correct or tighten connections.</p> <p>Position device(s) at proper level.</p> <p>Clean sensing device(s).</p> <p>Check installation for free movement of float.</p> <p>Repair or replace defective unit(s).</p>
OVERLOAD UNIT TRIPS	<p>Low or high voltage, or excessive voltage drop between pump and control box.</p> <p>Defective insulation in motor windings or power cable; defective windings.</p> <p>Impeller jammed due to debris or insufficient clearance.</p> <p>Bearings frozen.</p>	<p>Measure voltage at control box. Check that wiring is correct type, size, and length (see <b>Field Wiring Connection, Section B</b>).</p> <p>Check insulation resistance; check continuity.</p> <p>Disassemble pump and check impeller.</p> <p>Disassemble pump and check bearings.</p>

## TROUBLESHOOTING CHART (cont'd)

TROUBLE	POSSIBLE CAUSE	PROBABLE REMEDY
<p>MOTOR RUNS, BUT PUMP FAILS TO DELIVER RATED DISCHARGE.</p>	<p>Discharge head too high.</p> <p>Low or incorrect voltage.</p> <p>Discharge throttling valve partially closed; check valve installed improperly.</p> <p>Discharge line clogged or restricted; hose kinked.</p> <p>Liquid being pumped too thick.</p> <p>Strainer screen or impeller clogged.</p> <p>Insufficient liquid in sump or tank.</p> <p>Worn impeller vanes.</p> <p>Pump running backwards.</p>	<p>Reduce discharge head or install staging adaptor and additional pump.</p> <p>Measure control box voltage, both when pump is running and when shut off.</p> <p>Open discharge valve fully; check piping installation.</p> <p>Check discharge lines; straighten hose.</p> <p>Dilute liquid if possible.</p> <p>Clear clog(s). Stop pump; back flow may flush away debris.</p> <p>Stop pump until liquid level rises.</p> <p>Check impeller (see <b>PUMP END REASSEMBLY</b> in <b>Maintenance and Repair, Section E</b>).</p> <p>Check direction of rotation. If incorrect, interchange any two motor leads at the control box (3 phase models, see <b>Pump Rotation, Section C</b>).</p>
<p>PUMP RUNS WITH EXCESSIVE NOISE OR VIBRATION</p>	<p>Pumping entrained air.</p> <p>Damaged or unbalanced impeller.</p> <p>Discharge piping not properly supported.</p> <p>Impeller jammed or loose.</p> <p>Motor shaft or bearings defective.</p> <p>Pump is cavitating.</p>	<p>Check liquid level in sump; check position of pump and liquid level sensing device(s).</p> <p>Replace impeller.</p> <p>Check piping installation.</p> <p>Check impeller.</p> <p>Disassemble pump and check motor and bearings.</p> <p>Reduce discharge head or restrict flow on low head applications.</p>



**ELECTRICAL TESTING**

Make the electrical checks which follow to determine if pump malfunctions are being caused by problems in the motor or in the motor cable.

**Test Equipment**

A volt/amp/ohmmeter and megohmmeter of adequate range and quality are required to conduct the electrical tests which follow.

Equipment	Use
Ammeter	To check AC Voltage and current (amperage)
Ohmmeter	To measure resistance (ohms) to ground



Refer to the wiring diagram(s) accompanying the motor and control box before reconnecting any electrical leads which have been disconnected. Connections to the wrong terminals may damage the motor and/or control devices.

**Voltage Imbalance**

Use a voltmeter to read each phase of the incoming 3 phase power. Each phase must balance with the other two as closely as can be measured with a commercial instrument. If the phases are out of balance, contact your power company. If the phases are balanced, check out the motor as described in the following steps:

- a. Use a voltmeter, Amprobe, or equivalent instrument to read the voltage of incoming power lines 1 and 2, 2 and 3, and 1 and 3 at the control box. Voltage must match as closely as can be measured. If possible, measure the voltage at the control box with:

- 1. The pump shut off.
- 2. The pump running in air.

- 3. The pump submerged and running under full load.

The voltage measured under each condition must be the same.

- b. If voltage is balanced when the pump is off but is imbalanced when the pump is running, thoroughly check the power source, all interconnecting cables, and the pump motor to isolate the defect.
- c. Use an Amprobe or equivalent instrument to measure the current draw (amperage) of each phase while the pump is running under full load, and with no load. In each condition, the amperage readings for all three phases must match as closely as can be measured. Normal amperage values are listed in Table B-1 in **INSTALLATION**; these values apply only when the voltage at the site is the normal voltage listed.

**Power Cable Continuity**

Set the megohmmeter at R x 1 scale and zero-balance it. Test as follows:

- a. Shut off incoming power to the control box, and disconnect the motor power cable leads. Connect the megohmmeter test leads to any two cable leads, and note the megohmmeter reading. A high resistance reading indicates an open or broken circuit in the power cable or motor windings, or a bad connection between the motor and cable.
- b. Repeat Step a. with each set of leads. The three readings should be as close as can be measured.
- c. If readings indicate that continuity problems exist in the motor or power cable, the motor and/or terminal housing assembly must be repaired before putting the pump into service.

**Insulation Resistance**

Set the megohmmeter at R x 100, and zero-balance it. Test as follows:

- a. Shut off incoming power to the control box, and disconnect the motor power cable leads. Connect one megohmmeter test lead to the

motor cable green/yellow ground lead. Touch the other test lead to each of the motor cable leads in turn. Note the readings.

- b. Readings will indicate resistance values in both the power cable and motor windings. If resistance reads infinity ( $\infty$ ), insulation is good. If resistance reads between infinity ( $\infty$ ), and 1 megohm, insulation is acceptable but should be rechecked regularly. If resistance reads less than 1 megohm, insulation should be checked more closely and frequently.
- c. If readings indicate that a ground exists, test the stator and motor power cable separately. Replace as required.

## PUMP MAINTENANCE AND REPAIR – SECTION E

### GENERAL INFORMATION

Review all **SAFETY** information in Section A.



**Do not attempt to service the pump assembly unless all power to the motor has been shut off at the control box; otherwise, injury or death could result.**

**Use a lifting device with sufficient capacity. If slings or chains are used to move the pump or components, make sure that the load is balanced; otherwise serious personal injury or death could result.**

The maintenance and repair instructions in this manual are keyed to the illustrations, Figures E-1 and E-2, and the corresponding parts lists.

Select a suitable location, preferably indoors, to perform required maintenance. All work must be performed by qualified personnel.

Check **TROUBLESHOOTING**, Section B to determine causes and remedies of pump problems. Disassemble the pump only as far as required.

#### Lifting

Pump unit weights will vary depending on the mounting and drive provided. Check the shipping tag on the unit packaging for the actual weight, and use lifting equipment with appropriate capacity. Drain the pump and remove all customer-installed equipment such as suction and discharge hoses or piping before attempting to lift existing, installed units.

ILLUSTRATION

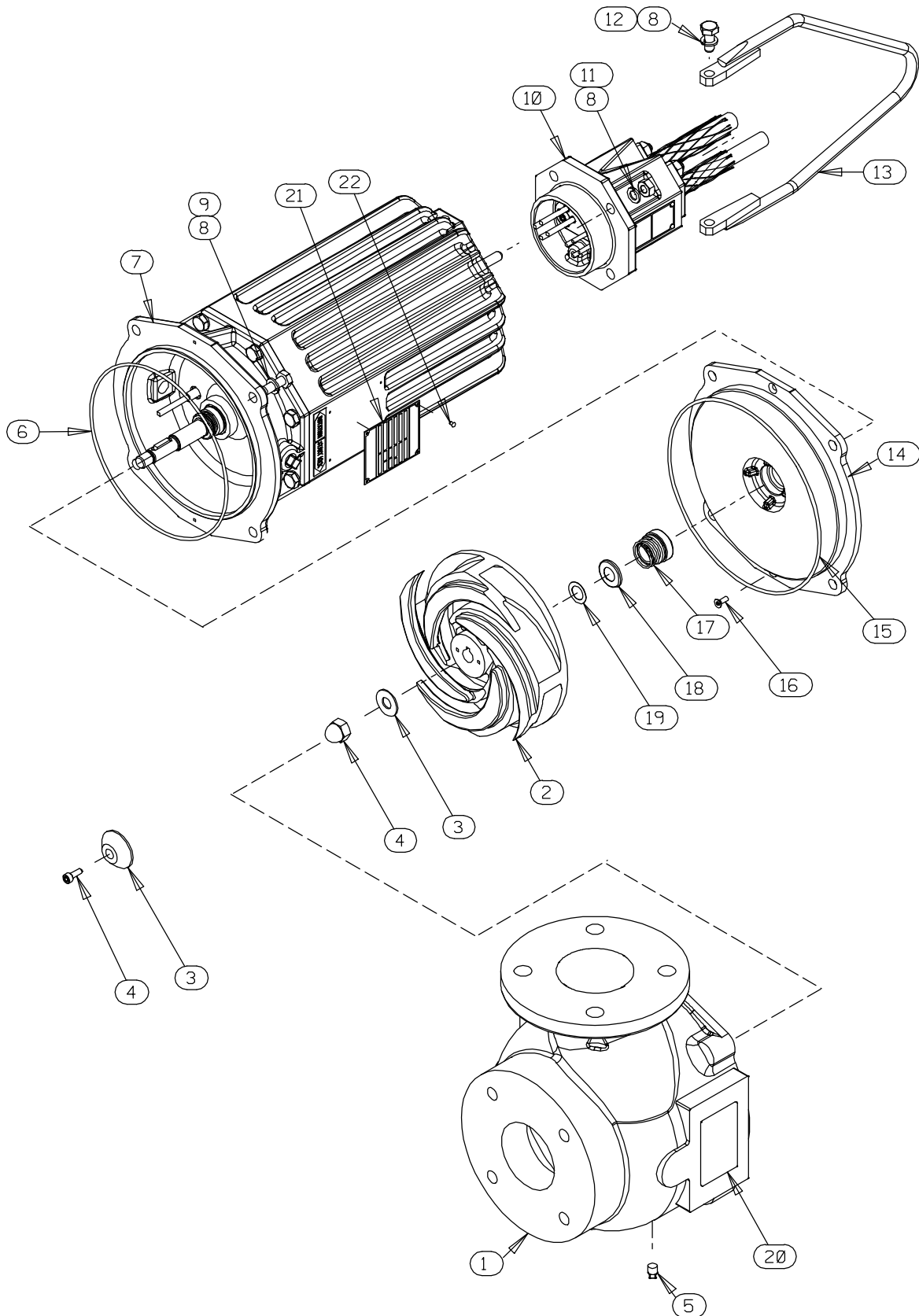


Figure E-1. SFDV3A & SFDEV3A Pump Model Assembly

**SFDV3A & SFDEV3A Pump Model Assembly**  
**Parts List**  
 (From S/N 1482269 Up)

If your pump serial number is followed by an "N", your pump is **NOT** a standard production model. Contact the Gorman-Rupp Company to verify part numbers.

ITEM NO.	PART NAME	PART NUMBER	QTY	ITEM NO.	PART NAME	PART NUMBER	QTY
1	PUMP CASING			13	LIFTING BAIL ASSY	44713-046 17040	1
	-ANSI	38224-522 10000	1	14	SEAL PLATE	38272-427 10000	1
	-DIN	38224-521 10000	1	15 *	O-RING	25152-267	1
2 *	IMPELLER	SEE NOTE		16	FLAT HD CAPSCREW	MF0514 17000	1
3 *	IMPELLER WASHER	MK14 17000	1	17 *	SEAL ASSY	25285-853	1
4 *	IMPELLER NUT	MBA14 17000	1	18 *	SPRING RETAINER	31161-041 17000	1
ALTERNATE IMPELLER HARDWARE:				19 *	IMP ADJ SHIM SET	513A 17090	1
3 *	IMPELLER WASHER	31167-037 17000	1	20	INFINITY DECAL	38811-435	1
4 *	SOCKET HD CAPSCREW	MBD0616 17000	1	21	NAME PLATE	38814-074 17000	1
5	PIPE PLUG	P02 17000	1	22	DRIVE SCREW	BM#04-03 17000	4
6 *	O-RING	25152-266	1	NOT SHOWN:			
7	MOTOR ASSY				STAGGERWING DECAL	38811-434	1
	-208-230/3	47111-804	1		* TERMI HOUSING O-RING	25154-153	REF
	-460/3	47111-801	1	OPTIONAL:			
	-575/3	47111-805	1		ANSI DRY PIT STAND KIT	48786-111	1
8	LOCK WASHER	MJ10 17000	10		-STAND	41321-521 24150	1
9	HEX HD CAPSCREW	MB1030 17000	4		-GASKET	38683-503 19020	1
10 *	10 METER TERMINAL HOUSING ASSY				-HEX HD CAPSCREW	B1009 17000	4
	-208-230/460/3	47367-701	1		ANSI SUCTION ELBOWS		
	-575/3	47367-702	1		-3" X 3" X 90°	S5012	1
	* 12 METER TERMINAL HOUSING ASSY				-3" X 4" X 90°	S5024	1
	-208-230/460/3	47367-703	1	ANSI DISCHARGE INCREASER KIT			
	-575/3	47367-704	1		INCREASER KIT	48135-501	1
	* 15 METER TERMINAL HOUSING ASSY				-INCREASER	S5133A	1
	-208-230/460/3	47367-705	1		-GASKET	38683-503 19020	1
	-575/3	47367-706	1		-HEX HD CAPSCREW	B1009 170001	4
	* 25 METER TERMINAL HOUSING ASSY				-LOCK WASHER	J10 17000	4
	-208-230/460/3	47367-707	1		-HEX NUT	D10 17000	4
	-575/3	47367-708	1		DIN DRY PIT STAND KIT	48786-115	1
	* 35 METER TERMINAL HOUSING ASSY				-STAND	41321-521 24150	1
	-208-230/460/3	47367-709	1		-GASKET	38683-503 19020	1
	-575/3	47367-710	1		-HEX HD CAPSCREW	MB1640 17000	8
	* 50 METER TERMINAL HOUSING ASSY			LIQUID LEVEL DEVICES:			
	-208-230/460/3	47367-711	1		DIAPHRAGM TYPE	GRP48-03	1
	-575/3	47367-712	1			GRP48-06	1
11	HEX NUT	MD10 17000	4		FLOAT TYPE	27471-180	1
12	HEX HD CAPSCREW	MB1025 17000	2		120V LIQUID LEVEL		
					CONTROL RELAY	27521-321	1

\* INDICATES PARTS RECOMMENDED FOR STOCK

NOTE: FOR IMPELLER P/N, CONTACT THE FACTORY WITH PUMP MODEL, S/N AND IMPELLER DIAMETER (FROM NAMEPLATE)

ILLUSTRATION

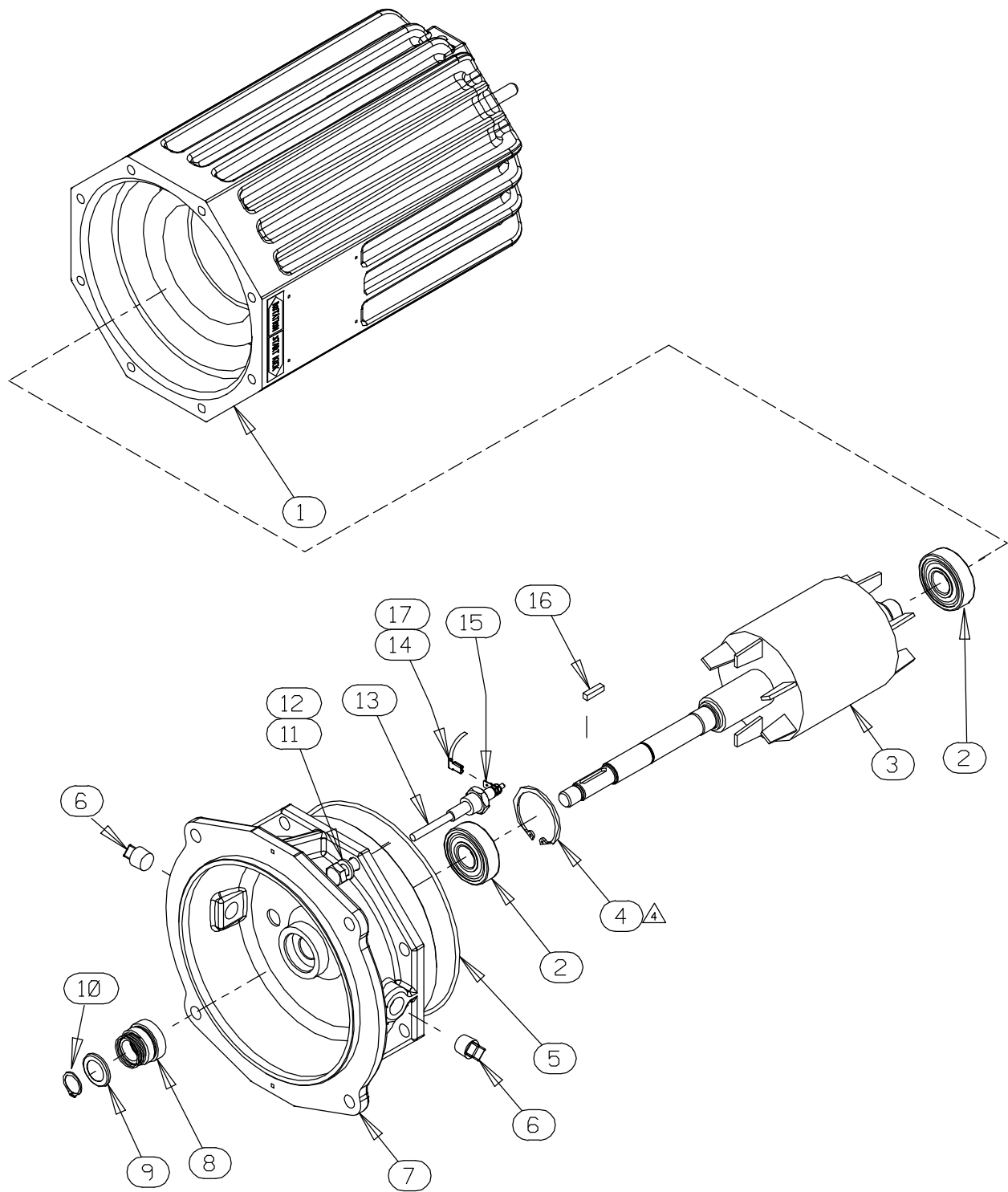


Figure E-2. 47111-801, -804 and -805 Motor Assemblies

**47111-801, -804 and -805 Motor Assemblies  
Parts List**

ITEM NO.	PART NAME	PART NUMBER	QTY
1	MOTOR SUBASSEMBLY		
	-208-230/3	47111-829	1
	--MOTOR HOUSING	38311-065 10000	1
	--STATOR	47113-089	1
	--TERMINAL HOUSING STUD	MC1042 17000	4
	--VOLTAGE TAG	38816-094	1
	--ROTATION DECAL	38815-027	1
	-460/3	47111-828	1
	--MOTOR HOUSING	38311-065 10000	1
	--STATOR	47113-089	1
	--TERMINAL HOUSING STUD	MC1042 17000	4
	--VOLTAGE TAG	38816-093	1
	--ROTATION DECAL	38815-027	1
	-575/3	47111-830	1
	--MOTOR HOUSING	38311-065 10000	1
	--STATOR	47113-090	1
	--TERMINAL HOUSING STUD	MC1042 17000	4
	--VOLTAGE TAG	38816-128	1
	--ROTATION DECAL	38815-027	1
2	* BEARING	S1905	2
3	☞ ROTOR/SHAFT ASSY	47112-084	1
4	BEVELED SNAP RING	24121-526	1
5	* O-RING	25152-264	1
6	PIPE PLUG	P06 17000	2
7	INTERMEDIATE	38261-034 10000	1
8	* SEAL ASSY	S1575	1
9	* CENTERING WASHER	31161-045 17000	1
10	SNAP RING	S987	1
11	LOCK WASHER	MJ10 17000	8
12	HEX HD CAPSCREW	MB1025 17000	8
13	MOISTURE DETECTOR	27479-008	1
14	FEMALE TERMINAL	27236-054	1
15	MALE TERMINAL	27236-454	1
16	* IMPELLER KEY	MN0520 17000	1
17	36" 18 AWG WIRE	18147-104	1
NOT SHOWN (SUPPLIED WITH MOTOR SUBASSEMBLY):			
	WIRE CONNECTOR	S1718	3
	POWER LEAD CONTACT	27216-004	3
	POWER LEAD CONTACT HOUSINGS:		
	-BLACK	27216-034	1
	-WHITE	27216-035	1
	-RED	27216-036	1
	CONTROL LEAD CONTACT	27216-002	3
	CONTROL LEAD CONTACT HOUSINGS:		
	-ORANGE	27216-031	1
	-BLUE	27216-032	1
	-BROWN	27216-033	1

\* INDICATES PARTS RECOMMENDED FOR STOCK

☞ NOTE: WHEN ORDERING A REPLACEMENT ROTOR/SHAFT ASSY, DETERMINE THE IMPELLER ATTACHEMENT HARDWARE FOR YOUR PUMP AS SHOWN IN FIGURE 1 AND ORDER REPLACEMENT HARDWARE AS REQUIRED.

## PUMP AND SEAL DISASSEMBLY AND REASSEMBLY

Review all **SAFETY** information in **Section A**.

This pump requires little service due to its rugged, minimum-maintenance design. However, if it becomes necessary to inspect or replace the wearing parts, follow these instructions, which are keyed to the illustrations (see Figures E-1 and E-2) and the corresponding parts lists.

This manual will alert personnel to known procedures which require special attention, to those which could damage equipment, and to those which could be dangerous to personnel. However, this manual cannot possibly anticipate and provide detailed precautions for every situation that might occur during maintenance of the unit. Therefore, it is the responsibility of the owner/maintenance personnel to ensure that **only** safe, established maintenance procedures are used, and that any procedures not addressed in this manual are performed **only** after establishing that neither personal safety nor pump integrity are compromised by such practices.



**Do not attempt to service the pump assembly unless all power to the motor has been shut off at the control box; otherwise, injury or death could result.**

**Use a lifting device with sufficient capacity. If slings or chains are used to move the pump or components, make sure that the load is balanced; otherwise serious personal injury or death could result.**



**If this pump is used to handle sewage, take necessary precautions during maintenance and repair to prevent personal contamination which could result in illness.**

Select a suitable location, preferably indoors, to perform required maintenance. All work must be performed by qualified personnel.

Check the chart in **TROUBLESHOOTING**, Section D of this manual, to determine the nature of the pump problem. If the problem is mechanical in nature, such as worn pump parts, seal replacement, lubrication, etc., refer to **PUMP END DISASSEMBLY** for instructions.

If the problem is electrical, complete disassembly may not be required. Refer to **Electrical Testing** in **TROUBLESHOOTING**, Section D, and have a qualified electrician check the control box, cable and terminal housing. If the problem is determined to be in the cable(s) or terminal housing, see **MOTOR DISASSEMBLY** for terminal housing replacement. If the problem is determined to be in the motor, proceed with **PUMP END DISASSEMBLY**, followed by **MOTOR DISASSEMBLY**.



**The electrical power used to operate this pump is high enough to cause injury or death. Make certain that the control handle on the control box is in the off position and locked out, or that the power supply to the control box has been otherwise cut off and locked out, before attempting to open or service the pump assembly. Tag electrical circuits to prevent accidental start-up.**

Carefully inspect any O-rings before removal and cleaning to determine if a proper seal and compression existed prior to disassembly. If sealing was faulty or questionable, the cause must be determined and corrected before reassembly. All O-rings **must** be replaced if disturbed.

### PUMP END DISASSEMBLY

#### Preparing Pump for Disassembly

Disconnect the suction and discharge piping and connect a suitable lifting device to the hoisting bail to remove the pump from the dry pit.





**Do not attempt to lift the pump by the motor power cable or the piping. Attach proper lifting equipment to the lifting device fitted to the pump. If chains or cable are wrapped around the pump to lift it, make certain that they are positioned so as not to damage the pump, and so that the load will be balanced.**

It is not necessary to remove the pump from the stand for most pump maintenance procedures. If desired to remove the pump from the stand, disengage the hardware securing the stand to the pump casing and remove the stand and gasket.

### **Pump Casing Removal**

#### **(Figure E-1)**

Position the pump assembly on a flat surface and use the lifting bail and lifting device to support the pump in a vertical position. Remove the hardware (8 and 9) securing the motor assembly (7) to the pump casing (1).

Using the lifting device, raise the motor assembly out of the pump casing. It may be necessary to tap around the circumference of the pump casing with a soft-faced mallet to break the seal between the casing and motor. When the motor is free of the pump casing, position the motor and remaining pump end components horizontally on a flat surface for further disassembly. Chock the pump to prevent rolling when positioned horizontally.

Remove the O-ring (15) from the outer shoulder of the seal plate (14).

### **Draining Oil From Seal Cavity**

#### **(Figure E-2)**

The seal cavity oil must be drained to prevent the oil from escaping as the impeller is removed.



Let the pump cool before removing the seal cavity drain plug. Pressure built up within a hot pump could cause the oil to spray out when the plug is removed. Remove the plug slowly and permit pressure to vent to atmosphere.

Lay the pump on its side with one of the pipe plugs (7) facing up. Clean any dirt from around the plug. Remove the plug slowly to release any pressure and install a short 3/8-inch NPT nipple in the hole. Roll the pump and drain the seal oil into a **clean** container. Inspect the oil for water, dirt, or cloudy condition which could indicate lower seal failure or poor O-ring seal.

### **Impeller Removal**

#### **(Figure E-1)**

Wedge a soft metal rod between the impeller vanes to prevent impeller rotation.

#### **NOTE**

*A strap wrench may also be used to immobilize the impeller.*

Remove the impeller nut (4).

#### **NOTE**

*If your pump is equipped with an impeller screw instead of the impeller nut, use a hex key in conjunction with an impact wrench to remove the screw.*

Remove the impeller washer (3). Remove the metal rod from between the vanes of the impeller.

To remove the impeller, use two thin-bladed screwdrivers positioned 180° apart to pry on the back of the impeller and “walk” the impeller off the shaft. Use increasingly larger screwdrivers (or wedges) as necessary. After the impeller comes free of the shaft, retain the impeller key (17, Figure E-2).

Remove the impeller adjusting shims (19). Tie and tag the shims for ease of reassembly.

If no further disassembly is required, proceed to the appropriate areas in **PUMP END REASSEMBLY**.

### Lower Seal Removal (Figures E-1 and E-3)

Carefully remove the spring retainer (18) and seal spring. Lubricate the rotor shaft with light oil and work oil under the bellows assembly. Pull the rotating portion of the seal off the shaft.

Work a pair of stiff wires with hooked ends between the rotor shaft and the stationary element and pull the stationary element and seat out of the seal plate (14).

#### NOTE

*An alternate method of removing the stationary element is to remove the screws (16) securing the seal plate (14) to the motor assembly (7). Pry the assembled seal plate and stationary element off the shoulder of the intermediate (7, Figure E-2). Remove the O-ring (6) and press the stationary element and seat out of the seal plate from the back side.*

If no further disassembly is required, proceed to the appropriate areas in **PUMP END REASSEMBLY**.

### Upper Seal Removal (Figures E-2 and E-3)

Unless cracked or otherwise worn, it is not necessary to remove the intermediate (7) for access to the upper seal assembly (8).

Remove the seal plate (14, Figure E-1) as described above in **Lower Seal Removal**.

Remove the seal retaining ring (10) using snap ring pliers. Use caution when removing the retaining ring; tension on the seal spring will be released. Remove the spring centering washer (9) and seal spring.

Lubricate the seal area of the rotor shaft (3) and work oil up under the bellows. Use the hooked ends of two stiff wires to hook the retainer and pull the rotating portion of the seal off the shaft.

Slide the hooked ends of two stiff wires along the shaft and under the stationary seal seat. Hook the back side of the seat and pull it from the intermediate bore.

If no further disassembly is required, proceed to the appropriate areas in **PUMP END REASSEMBLY**.

#### NOTE

*Do not disassemble the motor unless it is necessary and a clean, well-equipped shop is available. If the motor housing components are to be serviced, see **MOTOR DISASSEMBLY** in this section. Do not reassemble the pump end components at this time.*

## PUMP END REASSEMBLY

#### NOTE

*Reuse of old O-rings or shaft seal parts will result in premature leakage or reduced pump performance. It is strongly recommended that new O-rings and shaft seal assemblies be used during reassembly (see the parts lists for numbers).*

### Cleaning and Inspection of Pump Parts

#### (Figures E-1 and E-2)

With the pump inverted, stuff a clean tissue into the stationary seal seat bore of the intermediate (8, Figure E-2) or wrap a small rag around the shaft to prevent foreign material from entering the motor cavity.

Carefully inspect any O-rings before removal and cleaning to determine if a proper seal existed prior to disassembly. If sealing was faulty or questionable, the cause must be determined and corrected before reassembly. Replace any parts as required.

Thoroughly clean all reuseable parts with a soft cloth soaked in cleaning solvent. Remove all O-rings and clean the sealing surfaces.



**Most cleaning solvents are toxic and flammable. Use them only in a well ventilated area free from excessive heat, sparks, and flame. Read and follow all precautions printed on solvent containers.**

Inspect the rotor shaft (3, Figure E-2) for damaged threads, scoring, or nicks. Remove nicks and

burrs with a fine file or hand honing stone to restore original contours. If the shaft is bent or severely damaged, the rotor and shaft must be replaced as an assembly (see **MOTOR DISASSEMBLY**).

Neither of the shaft seal assemblies should be re-used because wear patterns on the finished faces cannot be realigned during reassembly. This could result in premature failure. If necessary to reuse an old seal in an **emergency, carefully** wash all metallic parts in fresh cleaning solvent and allow to dry thoroughly.

Handle the seal parts with extreme care to prevent damage. Be careful not to contaminate the precision finished faces; even fingerprints on the faces can shorten seal life. If necessary, clean the faces with a non-oil based solvent and a clean, lint-free tissue. Wipe **lightly** in a circular pattern to avoid scratching the faces.

Inspect the seal components for wear, scoring, grooves, and other damage that might cause leakage. If any components are worn, replace the complete seal; **never mix old and new seal parts**.

Install the shaft seals as illustrated in Figure E-3.

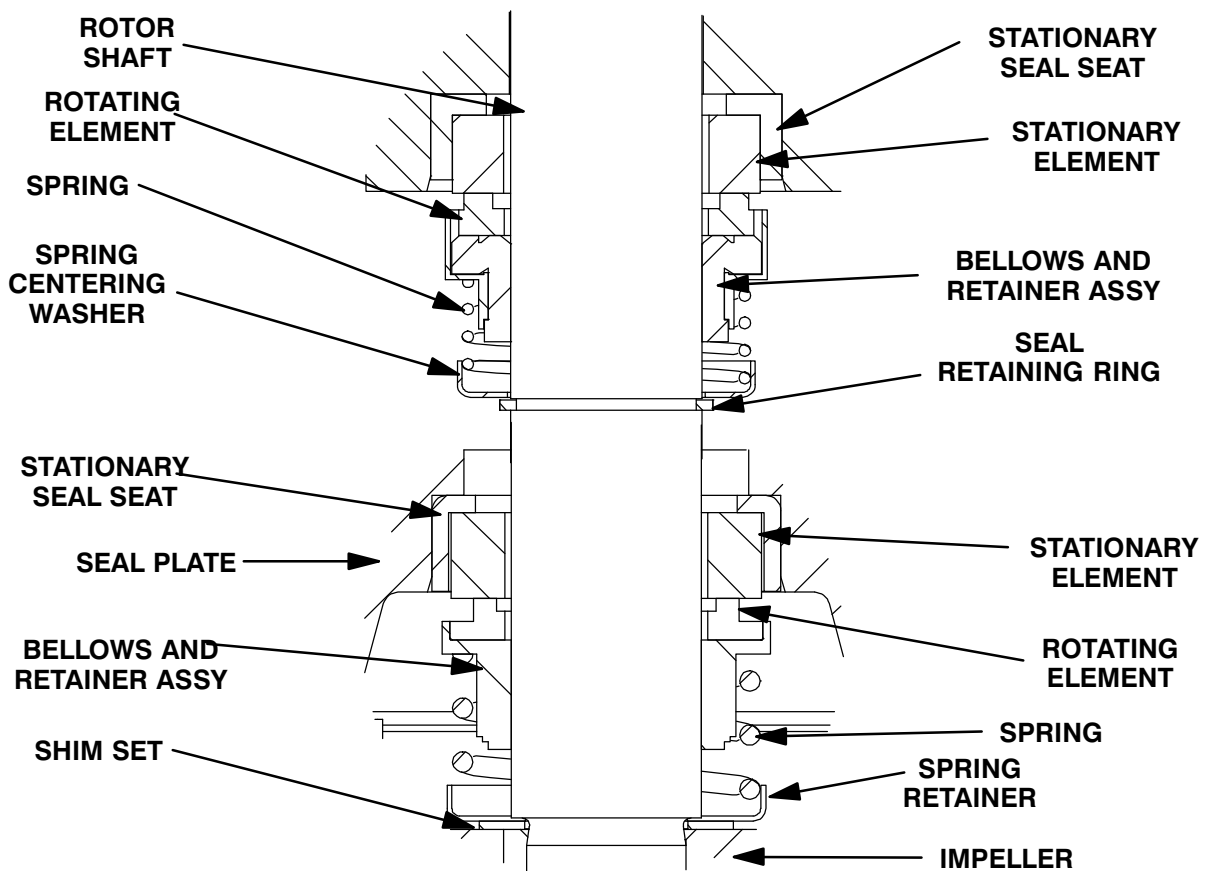


Figure E-3. Upper And Lower Seal Assemblies



The seal assemblies are not designed for operation at temperatures above 104°F (40°C). Do not use at higher operating temperatures.

**Upper Seal Installation**  
(Figures E-2 and E-3)

**Do not** unwrap a new seal assembly until time of installation. Cleanliness of seal components is critical, especially the seal faces.

Clean the rotor shaft (3) and seal cavity area of the intermediate (7). Be sure the area is dry and free of

lint and dirt. Check the seal bore for burrs or nicks that might prevent a good seal. Remove them with a fine file or emery cloth to restore original contours. If the shaft is bent or damaged, the complete rotor and shaft must be replaced as an assembly. Apply a **light** coating of oil to the bore of the intermediate.

Carefully remove the material stuffed into the seat bore (or unwrap the shaft). **Be sure** no debris stopped by the material falls into the seal cavity.

Subassemble the stationary element in the stationary seat. Position this subassembly in the intermediate bore with the sealing face up and cover the seal face with a clean tissue. Use your thumbs to press the assembly into the bore. Apply equal pressure on opposite sides until the seat contacts the bore shoulder. Remove the tissue and inspect the seal face to ensure that it is clean and dry. If cleaning is necessary, use clean tissue to wipe **lightly** in a circular pattern.

Unpack the rotating portion of the seal. Be certain the seal face of the rotating element is free of grit or surface damage. Because the rotating element may not stay in the bellows retainer when turned upside down, place a **small** amount of grease at equal spaces on the back of the element and position it in the bellows retainer. The grease should hold the element in position until the seal is installed. Assemble the drive grooves of the rotating element into the drive lugs of the bellows retainer.

### NOTE

*When pressing seal components onto the shaft, use hand pressure only. A push tube cut from a length of plastic pipe will aid in installing seal components. The I.D. of the push tube should be approximately the same as the I.D. of the seal spring.*

Apply a **light** coating of oil to the seal seating surface on the shaft, the groove for the retaining ring (10) and I.D. of the bellows. Position the seal rotating portion on the shaft with the seal face down. Apply firm, steady pressure on the bellows retainer until it slides down the shaft and the seal faces contact. This step should be done in one continuous motion to prevent the bellows from sticking or rolling as it passes over the retaining ring groove.

Slide the seal spring over the shaft and bellows retainer and install the spring centering washer (9). Install the seal retaining ring (10). See Figure E-3 for the proper order of seal assembly.

### Lower Seal Installation

#### (Figures E-1 and E-3)

Thoroughly clean the O-ring surfaces and seal bore of the seal plate (14). The seal bore must be free of burrs and nicks which could damage the seal. Inspect the seal plate for cracks, distortion, or erosion and replace it if defective.

Position the seal plate on a clean flat surface with the impeller side up.

Unpack the stationary seat and element. Subassemble the stationary element in the stationary seat. Apply a **light** coating of oil to the seal plate bore and the O.D. of the seal stationary seat. Keep the sealing face dry.

Position the subassembly in the seal plate bore, and cover it with a clean tissue. Use your thumbs to press the seat into the bore. Apply equal pressure on opposite sides of the seat until it is fully seated in the bore. Remove the tissue and inspect the seal face to ensure that it is clean and dry. If cleaning is necessary, use clean tissue to wipe **lightly** in a circular pattern.

Install a new O-ring (6) on the shoulder of the intermediate (7, Figure E-2).

Carefully position the seal plate and stationary seal components on the rotor shaft. Align the holes in the seal plate for the capscrews (16) with those in the intermediate and slide the seal plate onto the shaft until fully seated against the intermediate. **Be careful** not to damage the stationary element already installed in the seal plate. Secure the seal plate to the intermediate with the flat head capscrews (16).

### NOTE

*If the seal plate was not removed during disassembly, cover the stationary element with a clean tissue and use your thumbs to press the seal stationary seat and element into the seal plate as described above. Remove the tissue and inspect the seal face to ensure that it is clean and dry.*

Unpack the rotating portion of the seal. Be certain the seal face of the rotating element is free of grit or surface damage. Because the rotating element may not stay in the bellows retainer when turned upside down, place a **small** amount of grease at equal spaces on the back of the element and position it in the bellows retainer. The grease should hold the element in position until the seal is installed. Assemble the drive grooves of the rotating element into the drive lugs of the bellows retainer. Apply a **light** coating of oil on the shaft and the I.D. of the bellows.

### NOTE

*When pressing seal components onto the rotor shaft, use hand pressure only. A push tube cut from a length of plastic pipe will aid in installing seal components. The I.D. of the push tube should be approximately the same as the I.D. of the seal spring.*

Slide the seal rotating portion onto the lubricated shaft with the seal face down. Apply firm, steady pressure on the bellows retainer until it slides down the shaft and the seal faces contact.

Install the seal spring over the bellows retainer and install the spring retainer (18). See Figure E-3 for proper order of seal assembly.

### Impeller Installation

#### (Figure E-1)

Inspect the impeller (2) for cracks, broken vanes, or wear from erosion and replace it if damaged. Clean the threads in hole in the rotor shaft for the impeller screw (4).

Install the same thickness of adjusting shims (19) as previously removed. Install the impeller key (16, Figure E-2) in the rotor shaft keyway. Align the keyway of the impeller (2) with the shaft key and push the impeller onto the shaft until seated firmly against the upper impeller shim set.

A clearance of .020 to .040 inch (0,51 to 1,02 mm) between the impeller and the seal plate is recommended for maximum pump efficiency. Measure this clearance and add or remove impeller adjusting shims as required.

**After** the impeller is installed, coat the threads of the rotor/shaft (or impeller screw, if so equipped) with 'Loctite Threadlocker No. 242' or equivalent compound. Install the impeller washer (3). Wedge a soft metal bar between the vanes of the impeller or use a strap wrench to prevent shaft rotation. Torque the impeller nut (4) to 78 ft. lbs. (10,8 m. kg.). If so equipped, torque the impeller screw to 5.6 ft. lbs. (67 in. lbs. or 7,6 m. kg.).

Remove the block of wood and turn the impeller to check for free rotation.

### Pump Casing Installation

#### (Figure E-1)

Install a new O-ring (15) on the shoulder of the seal plate. Orient the pump casing (1) as shown in Figure E-1 and slide it over the seal plate shoulder until fully seated. Apply "Never-Seez" or equivalent compound to the capscrews (9) and secure the pump casing to the seal plate and motor assembly (7) with the hardware (8 and 9). Torque the capscrews to 27 ft. lbs. (327 in. lbs. or 3,8 m. kg.).

### Final Assembly

If the pump was separated from the stand for disassembly, replace the gasket, position the pump on the stand and secure it with the previously removed hardware.

Reconnect the discharge hose (if used) before using a suitable lifting device to reposition the pump in the wet well or sump. If discharge piping was used, reconnect the piping after positioning the pump in the wet well or sump.

### MOTOR DISASSEMBLY

Disassembly of the motor is rarely required except to replace the motor rotor, stator or bearings. Do not disassemble the motor unless it is necessary and a clean, well-equipped shop is available.

### NOTE

*It is recommended that a pump with a defective motor be returned to Gorman-Rupp, or to a Gorman-Rupp authorized Submersible Repair Center.*



**The electrical power used to operate this pump is high enough to cause injury or death. Make certain that the control handle on the control box is in the off position and locked out, or that the power supply to the control box has been otherwise cut off and locked out, before attempting to open or service the pump assembly. Tag electrical circuits to prevent accidental start-up.**

Carefully inspect any O-rings before removal and cleaning to determine if a proper seal and compression existed prior to disassembly. If sealing was faulty or questionable, the cause must be determined and corrected before reassembly. Replace any parts as required.

### Hoisting Bail Removal

#### (Figure E-1)

The hoisting bail (13) must be removed in order to remove the terminal housing assembly (10). To remove the hoisting bail, disengage the hardware (8 and 12) and separate the bail from the motor housing.

### Terminal Housing Assembly Removal

#### (Figure E-1)

The terminal housing assembly (10) may be replaced without disassembling the motor or pump end components.

With the pump secured in an upright position, remove the hardware (8 and 11) securing the terminal housing assembly to the motor assembly (7). Carefully pull the terminal housing assembly out of the motor housing until the power and motor cable connections with the stator leads can be accessed.

The contacts on the ends of each cable lead are secured in a plastic housing which mates with a corresponding housing on each of the stator leads. Carefully pull each of the cable lead housings apart from its corresponding stator lead housing and re-

move the terminal housing assembly from the pump.

Further disassembly of the terminal housing assembly is not required. Individual parts are not sold separately.

See **Terminal Housing Assembly Installation** if no further disassembly is required.

### Rotor Shaft and Bearing Removal

#### (Figure E-2)

See **PUMP END DISASSEMBLY**, and remove all pump end and seal components.

With the pump end disassembled and the seal cavity drained of oil, secure the pump in an inverted position. Remove the hardware (11 and 12) securing the intermediate (7) to the motor subassembly (1).

Carefully pull the assembled intermediate, rotor shaft (3) and bearings (2) out of the motor housing until the female terminal (14) can be accessed. Pull the female terminal off the male terminal (15) and remove the intermediate, rotor shaft and bearings from the motor assembly. Remove the O-ring (5) from the intermediate shoulder.

If the moisture sensor (13) requires replacement, unscrew it from the hole in the intermediate.

Remove the snap ring (4) from the groove in the intermediate and pull the assembled rotor shaft and bearings out of the intermediate.



To prevent damage during removal from the shaft, it is recommended that bearings be cleaned and inspected **in place**. It is **strongly** recommended that the bearings be replaced **any** time the shaft and rotor assembly is removed.

Before removing the bearings from the rotor shaft, clean and inspect the bearings **in place** as follows.

Clean the bearings thoroughly in **fresh** cleaning solvent. Dry the bearings with filtered compressed air and coat with light oil.



## WARNING!

**Most cleaning solvents are toxic and flammable. Use them only in a well ventilated area; free from excessive heat, sparks, and flame. Read and follow all precautions printed on solvent containers.**

Rotate the bearings by hand to check for roughness or binding. If rotation is rough, replace the bearings.

The bearing tolerances provide a tight press fit onto the shaft and a snug slip fit into the motor housing and intermediate bearing bores. Replace the shaft and rotor (as an assembly), the motor housing or intermediate if the proper bearing fit is not achieved.

If replacement is required, use a bearing puller to remove the upper and lower bearings from the rotor shaft.

If no further disassembly is required, cover the motor housing with a clean, lint free cloth to avoid contamination by dirt or other foreign material.

### Stator Removal

(Figure E-2)



## CAUTION

Stator replacement requires specialized equipment, experience with electric motors, and at least two people to perform the task. Therefore, it is recommended that stator replacement be performed only by the factory or a Gorman-Rupp Authorized Submersible Repair Center, or that the motor housing and stator be replaced as an assembly (refer to the parts list, page E-5 for the appropriate part number).

Do not remove the stator (not shown) unless it is defective (open windings, insulation resistance low, or stator core damaged). If the stator must be

removed, position the motor housing upside down on a flat work surface.

Position an expandable tool, such as a split disc, approximately 2 inches (51 mm) down inside the stator and expand it tightly and squarely on the I.D. Attach a suitable lifting device to the lifting eye of the tool, and raise the motor housing and stator assembly approximately 1 inch (25 mm) off the work surface.

The motor housing must be heated to expand it enough for the stator to be removed. Using two propane heat torches of the type designed to melt ice or burn weeds from sidewalks and driveways, apply heat quickly and evenly to the outside of the motor housing; excessive heat is not required. When the stator begins to move, allow the motor housing to drop onto the work surface, and raise the lifting device to continue to pull the stator out of the motor housing until free.



## CAUTION

Take care not to damage the stator end turns during removal from the motor housing.

After the stator has been removed, wrap it in clean, dry rags or other suitable material until reassembly. The stator **must** be kept clean and dry. When handling the stator, **do not** set it on the end windings; lay it on its side.

### MOTOR REASSEMBLY



## CAUTION

Do not attempt to rewind the stator. Winding tolerances and materials are closely controlled by the manufacturer and any deviation can cause damage or operating problems. Replace the stator, or return it to one of The Gorman-Rupp Authorized Submersible Repair Centers or The Gorman-Rupp factory, if defective.

### NOTE

*Reuse of old O-rings or shaft seal parts will result in premature leakage or reduce pump performance. It*

is strongly recommended that new O-rings and shaft seal assemblies be used during reassembly (see the parts list for numbers).

## Stator Installation

(Figure E-2)

### NOTE

Stator installation involves heating the motor housing. This process must be done quickly; therefore it is recommended that these steps be performed by at least two people to promote efficient installation of the stator.

Clean all O-ring surfaces of the motor housing. Inspect the sealing surfaces for burrs, nicks and pits which could cause a poor seal and replace defective parts as required.

Thoroughly clean the inside of the motor housing with fresh solvent. The interior **must** be dry and free of dirt or lint.



**Most cleaning solvents are toxic and flammable. Use them only in a well ventilated area; free from excessive heat, sparks, and flame. Read and follow all precautions printed on solvent containers.**

After the motor housing is thoroughly cleaned, position it on a flat surface and secure it in an inverted position. Do not unwrap the stator until the motor housing has been prepared for stator installation. The stator **must** be kept clean and dry. When handling the stator, do not set it on the end windings; lay it on its side and block it from rolling.

Test the new stator as indicated in **Electrical Testing** in **TROUBLESHOOTING**, Section D, to ensure that no damage has occurred during transit or handling.

### NOTE

Remove any drops of varnish from the ends of the stator before installation to ensure proper stack-up

height when assembled.

The O.D. of the stator must be painted with GE Glyptal insulating paint just prior to being installed in the motor housing. The paint should still be wet when the stator is installed.

Position an expandable tool, such as a split disc, approximately 2 inches (51 mm) down inside the stator (opposite the lead wire end), and expand it tightly and squarely on the I.D. Attach a lifting device to the lifting eye of the tool, and carefully lift the assembly. Take care not to damage the stator end turns. Tape the stator leads together to protect them during installation.

### NOTE

Stator installation involves heating the motor housing. This process must be done quickly to allow the stator to slide into the motor housing before the housing cools.

Using two propane heat torches of the type designed to melt ice or burn weeds from sidewalks and driveways, heat the motor housing to expand it enough for the stator to be installed; when heating the motor housing, **make sure** that the stator is clear to avoid a fire hazard, or damage to the windings. Apply heat evenly to the outside of the housing; excessive heat is not required.

When the motor housing is sufficiently heated, position the stator so that the leads are in line with the terminal housing opening. Carefully lower the stator into the motor housing until fully seated against the housing shoulder. This should be done quickly to prevent the stator from sticking in the housing before it is fully seated. Be careful not to damage the stator lead insulation during reassembly.

After the stator is fully and squarely seated on the motor housing shoulder, remove the expandable disc tool. Untape the stator leads.

Cover the motor housing with a clean, lint-free cloth while the rotor is being assembled.

## Bearing and Rotor Shaft Installation

(Figure E-2)

If the moisture sensor (13) was removed for replacement, screw the new sensor into the hole in



the intermediate until fully seated. If removed, install a new male terminal (15) on the sensor and position it so the moisture sensor female terminal (14) can be easily attached.

Inspect the rotor shaft (3) for damaged threads, scoring in the seal area, and a nicked or damaged keyway. If the bearings were removed, inspect the bearing areas for scoring or galling. Remove nicks and burrs with a fine file or emery cloth. Inspect the rotor area for separated laminations. If the shaft is bent or damaged, or if the laminations are separated, replace the shaft and rotor (a single assembly).



To prevent damage during removal from the shaft, it is recommended that bearings be cleaned and inspected **in place**. It is **strongly** recommended that the bearings be replaced **any** time the shaft and rotor assembly is removed.

The bearings may be heated to ease installation. An induction heater, hot oil bath, electric oven, or hot plate may be used to heat the bearings. Bearings should **never** be heated with a direct flame or directly on a hot plate.

#### NOTE

*If a hot oil bath is used to heat the bearings, both the oil and the container must be **absolutely** clean. If the oil has been previously used, it must be **thoroughly** filtered.*

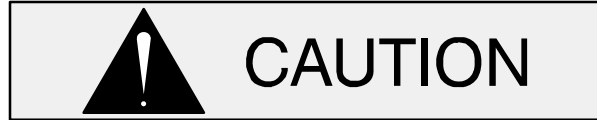
Slide the snap ring (4) over the shaft with the beveled edge of the snap ring facing the rotor.

Heat the bearings (2) to a uniform temperature **no higher than** 250°F (120°C). Slide the bearings onto the shaft, one at a time, until they are fully seated against the shaft shoulders. This should be done quickly, in one continuous motion, to prevent the bearings from cooling and sticking on the shaft.



**Use caution when handling hot bearings to prevent burns.**

If heating the bearings is not practical, use a suitably sized sleeve and an arbor (or hydraulic) press to install the bearings on the shaft.



When installing the bearings onto the shaft, **never** press or hit against the outer race, balls, or ball cage. Press **only** on the inner race.

After the bearings have been installed and allowed to cool, check to ensure that they have not moved out of position in shrinking. If movement has occurred, use a suitably sized sleeve and a press to reposition the bearings. Make certain that they are seated squarely against the shaft shoulders.

Use **fresh** solvent to clean all O-ring surfaces of the motor housing and intermediate (7). Inspect the sealing surfaces for burrs, nicks and pits which could cause a poor seal. Repair or replace as require.



**Most cleaning solvents are toxic and flammable. Use them only in a well ventilated area free from excessive heat, sparks, and flame. Read and follow all precautions printed on solvent containers.**

Position the intermediate with the impeller end down on some wood blocks tall enough to allow for installation of the rotor shaft through the intermediate.

Slide the assembled shaft and bearings into the intermediate until the lower bearing seats squarely in the intermediate bore. Secure the rotor and shaft to the intermediate by installing the snap ring (4) in the groove in the intermediate bore.

Install a new O-ring (6) on the shoulder of the intermediate.

With the motor housing and stator positioned upside down, carefully lower the assembled intermediate, rotor shaft and bearings into the motor housing until the female terminal (14) can be securely attached to the male terminal (15) on the moisture sensor.

Position the intermediate so the holes for the mounting hardware in the intermediate align with those in the motor housing and press the intermediate into the motor housing until fully seated. Apply "Never-Seez" or equivalent compound on the threads of the capscrews (12) and secure the intermediate to the motor housing with the hardware (11 and 12). Torque the capscrews to 28 ft. lbs. (327 in. lbs. or 3,8 m. kg.).

### Terminal Housing Assembly Installation

(Figure E-1)



**The electrical power used to operate this pump is high enough to cause injury or death. Make certain that the control handle on the control box is in the off position and locked out, or that the power supply to the control box has been otherwise cut off and locked out, before attempting to open or service the pump assembly. Tag electrical circuits to prevent accidental startup. Obtain the services of a qualified electrician to make electrical connections.**

Secure the pump in upright position with the hoisting bail and terminal housing assembly removed. Clean the area round the motor housing opening with fresh cleaning solvent, being careful not to allow any dirt, debris or cleaning solvent to enter the motor housing.



**Most cleaning solvents are toxic and flammable. Use them only in a well ven-**

**tilated area free from excessive heat, sparks, and flame. Read and follow all precautions printed on solvent containers.**

Make sure that the terminal housing O-ring supplied with the replacement terminal housing assembly is securely installed on the shoulder of the terminal housing and that it is clean and undamaged. Check to ensure that the power and control cable ground leads are securely attached to the inside of the terminal housing body.

Make sure the contacts on the ends of the power and control cable leads are firmly installed in their respective housings and position the terminal housing over the opening in the top of the motor housing.

Check to ensure that the contacts on the ends of the motor stator leads are firmly installed in their respective housings. Check to ensure that any wire connectors installed on the stator leads are tight and secured with heat shrink tubing.

The plastic housings on the ends of the power and control cable leads are color-coded to match the housings on the leads coming off the stator. Match each cable lead housing with its corresponding stator lead housing and firmly press them together until they lock in place.

When all of the cable lead housings are securely locked into the stator lead housings, slide the terminal housing assembly down over the studs in the top of the motor housing. Secure the terminal housing to the motor housing by tightening the hardware (8 and 11) in an alternating pattern until the terminal housing is fully seated in the motor housing. Torque the hex nuts (11) to 27 ft. lbs. (3,7 m. kg.).

After installing the motor housing, perform the vacuum check described below to ensure the water-tight integrity of the pump.

Reconnect the power and control cable leads to the control box. Check pump rotation as described in **OPERATION**, Section C, before putting the pump back into service.

## Hoisting Bail Installation

### (Figure E-1)

If the hoisting bail (13) was removed in order to remove the terminal housing assembly (10) position the bail over the motor housing so the holes for the mounting hardware align. Apply “Never-Seez” or equivalent compound to the threads of the capscrews (8) and secure the bail to the motor housing with the hardware (8 and 12). Torque the capscrews to 28 ft. lbs. (327 in. lbs. or 3,8 m. kg.).

## VACUUM TESTING

To ensure the water-tight integrity of the pump, the

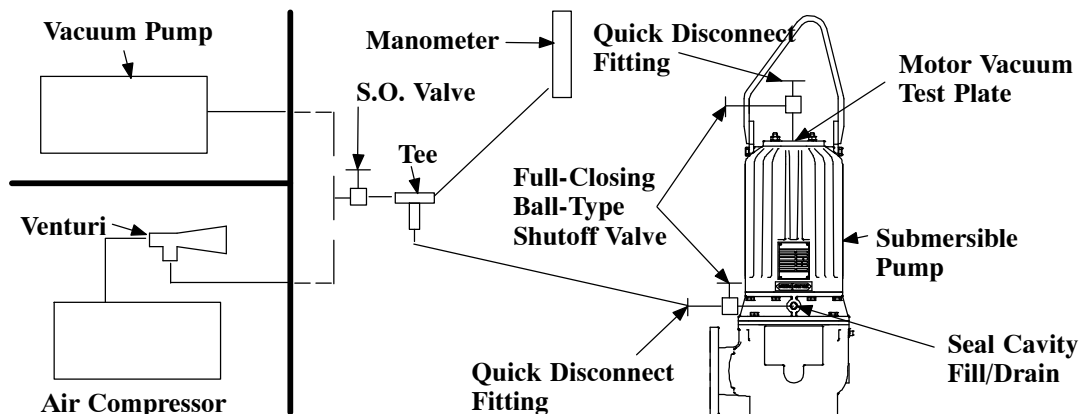


Figure E-4. Vacuum Test System

### Seal Cavity Testing

If the water-tight integrity of the motor was not disturbed during disassembly, the seal cavity can be tested without testing the motor.

Drain **all** of the oil from the seal cavity before performing the test. Oil within the cavity will be drawn into the system, resulting in damage to the vacuum pump or manometer.

See Figure E-4 and connect the vacuum pump or compressor/venturi system directly to the pump at the hole for the seal cavity drain plug (6, Figure E-2).

Draw the seal cavity vacuum down to **not more than** 10 In. Hg. and hold for 10 minutes. If no change in vacuum reading is detected, proceed with **LUBRICATION**.

motor and seal cavities must be vacuum tested any time the seal(s) and/or motor are serviced.

Use a manometer with a range of 30 to 0 to 30 inches of mercury to perform the test. **Do not** use a vacuum gauge. Vacuum gauges are not sensitive enough to detect minor leaks.

It is recommended that a vacuum pump be used to draw the vacuum on the cavities. If a vacuum pump is not available, a compressor/venturi system may be used. If the compressor/venturi cannot draw the higher vacuum level shown in Table E-1, draw the motor cavity vacuum down as far as the system will allow, then draw the seal cavity down so the differential between the two cavities is the same as the differential between the vacuum readings shown in the table.



**Do not** draw the seal cavity vacuum below 10 In. Hg. Lower vacuum can cause separation of the seal faces and/or unseating of the upper seal stationary seat, resulting in seal leakage.

### Seal and Motor Cavity Testing

Connect the vacuum pump or compressor/venturi system to the pump as shown in Figure E-4.

If the compressor/venturi cannot draw the higher vacuum level shown in Table E-1, draw the motor cavity vacuum down as far as the system will allow, then draw the seal cavity down so the differential between the two cavities is the same as the differ-

ential between the vacuum readings shown in the table.

To vacuum test the motor cavity, the terminal hous-

ing assembly must be replaced with a test plate. Make the test plate as shown in Figure E-5 below, install the terminal housing O-ring under the test plate, then proceed with vacuum testing.

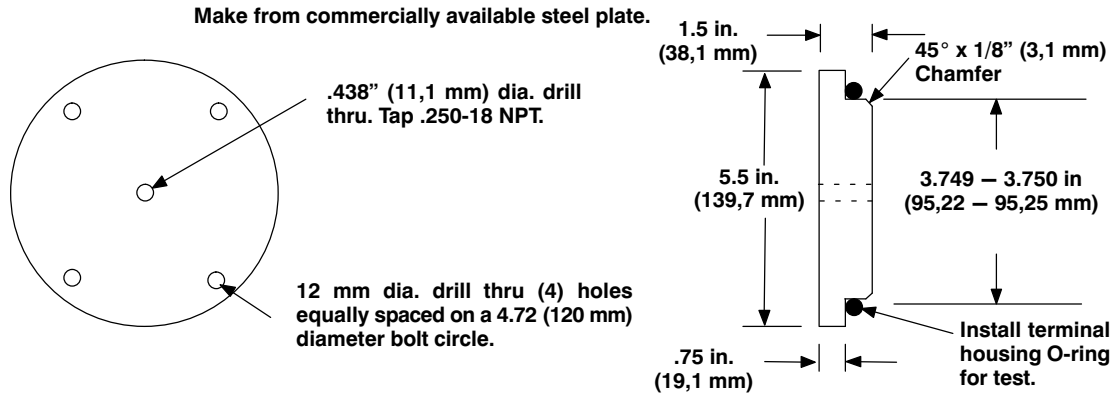


Figure E-5. Motor Vacuum Test Plate

Install full-closing ball-type shutoff valves with quick-disconnect fittings in the pipe plug holes in both the motor and seal cavities. Test the motor cavity for its full duration first, then use the shutoff valve to maintain the motor cavity vacuum while testing the seal cavity. The motor cavity vacuum **must** be higher than the vacuum in the seal cavity to prevent separation of the seal faces or unseating the stationary seal seat between the seal and motor cavities.

Figure E-4 shows a simple schematic for setting up either a vacuum pump or a venturi/compressor test system.

Table E-1 shows the vacuum to be drawn on each cavity, and the duration to maintain each vacuum reading. **Any** change in vacuum reading during the test indicates a leak which **must** be identified and corrected before putting the pump back into service.

Table E-1. Vacuum Test Data

Motor Cavity Vacuum (In. Hg.)	Duration (Minutes)	Seal Cavity Vacuum (In. Hg.)	Duration (Minutes)
20	3	30	1

LUBRICATION

Seal Cavity

Check the oil level in the seal cavity before initial startup, after the first two weeks of operation, and every month thereafter.



**Check the oil level only when the pump is cool. If the oil level plug is removed when the pump is hot, pressure in the seal cavity can cause hot oil to be ejected as the plug is removed.**

To check the seal cavity oil, clean any dirt from around the seal cavity drain plug (6, Figure E-2). Remove the plug, and screw a short 1/4 inch NPT nipple into the hole. Plug the open end of the nipple with your finger. Tip the pump and drain off a small amount of oil into a transparent cup, and stand the pump up again. If the oil level is abnormally low, or the color milky or dark, refer to **Draining Oil From Seal Cavity** in this section for instructions and troubleshooting tips. If the oil is clear, remove the nipple, top off the seal cavity with oil, and reinstall the level plug.

When lubricating a dry (overhauled) pump, position the pump upright and fill the seal cavity until oil reaches the bottom of the oil drain plug hole with approximately 36 ounces (1 liter) of oil.

The grade of lubricant used is critical to the operation of this pump. Use premium quality hydraulic oil as specified in Table E-2.

**Table E-2. Pump Oil Specifications**

Specifications:	
Type .....	Premium high viscosity index, anti-wear hydraulic oil
Viscosity (SSU @ 104°F [40°C]) .....	110 to 155
Viscosity (SSU @ 210°F [100°C]) .....	40 to 50
Dielectric .....	26,000 (volts-min)
Recommended supplier:	
Gulf Oil Company .....	Gulf Harmony AW Hydraulic Fluid MG 32
Acceptable alternate suppliers:	
Gulf Oil Company .....	Gulf Harmony 32 AW
Texas Oil Company .....	Rando HD 32 or HD AZ 32
Sun Oil Company .....	Sunvis 816 or 916
BP (Also Boron) .....	Energol-HLP 32
Shell Oil Company .....	Tellus 32, Tellus T-23 or T32
ARCO .....	Duro 32
Exxon (Also Esso) .....	Nuto H 32
Petro-Canada .....	Harmony HVI 22

**Motor Bearings**

The motor bearings are permanently sealed and no additional lubrication is required.

**For Warranty Information, Please Visit  
[www.grpumps.com/warranty](http://www.grpumps.com/warranty)  
or call:  
U.S.: 419-755-1280  
Canada: 519-631-2870  
International: +1-419-755-1352**

**GORMAN-RUPP PUMPS**